

Features

- Compatible with VDSL2、ADSL2
- Low Capacitance and Leakage Current
- Balanced overvoltage protection
- Low Clamping Voltage
- Response Time under 500ns
- Low insert loss

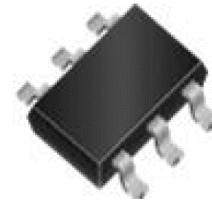

SOT23-6

Standards Compatibility

- ANSI/IEEE C62.41
- IEC 61000-4-5, 30A ($t_p=8/20\mu s$)
- IEC 61000-4-2 level 4
 - 15KV (air discharge)
 - 8KV (contact discharge)

Schematic&PIN Configuration

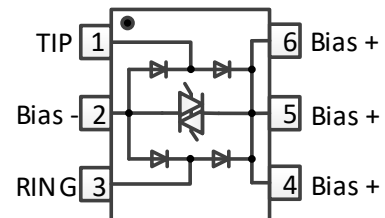

Main Application

The Ultra-low Capacitance series provides overvoltage protection for applications such as VDSL2, ADSL2, and ADSL2+ with minimal effect on data signals. When the voltage between Tip and Ring exceeds the reference voltage, the WEOS5-024GF device will work under 500ns. The device is also bi-directional between pin1 to pin3. All electrical parameters and surge ratings apply to forward and reverse polarities.

Maximum Surge Ratings(between pin1 and pin 3, $T_A=25^\circ C$)

Parameter	Symbol	Value	Unit
Non-repetitive impulse current $8/20^* \& 1.2/50^{**}$ (IEC 61000-4-5)	I_{PP}	30	A

Notes: *Current waveform in μs , **Voltage waveform in μs .

Electrical Characteristics (between pin 1 and pin 3, $T_A = 25^\circ C$)

Part Number	V_{DRM}	$I_{DRM}@V_{DRM}$	V_{BO}	I_H	C_o @f=1MHz, 2V	Delta C_o @Line Bias=1V to V_{DRM}
	V	nA	V	mA	pF	pF
	Max.	Max.	Max.	Typ.	Max.	Max.
WEOS5-024GF	24	100	40	40	3.0	0.5

V_{DRM}: Stand-off voltage, is measured at 100nA.

I_H: Holding current.

I_{DRM}: Leakage current at V_{DRM}.

C_o: Off-state capacitance.

V_{BO}: Breakover voltage, is measured at 100V/μs.

Thermal Information

Symbol	Parameter	Value	Unit
T _s	Storage temperature range	-55 to +150	°C
T _J	Maximum junction temperature	-40 to +125	°C

Electrical Characteristics Curves

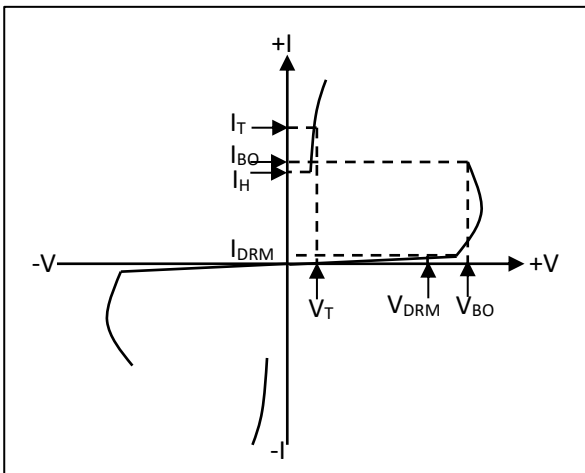

V-I Characteristics

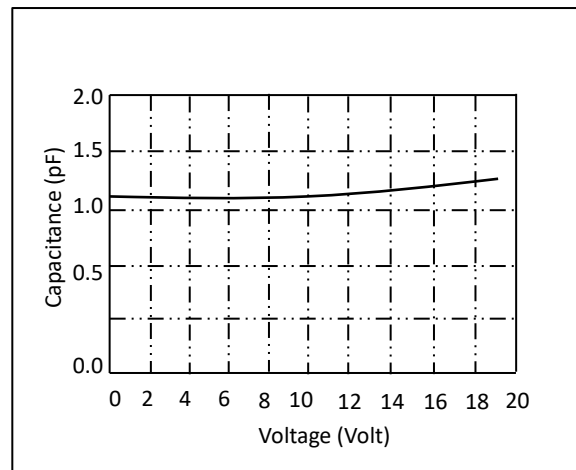

Typical capacitance against line voltage (without external bias)

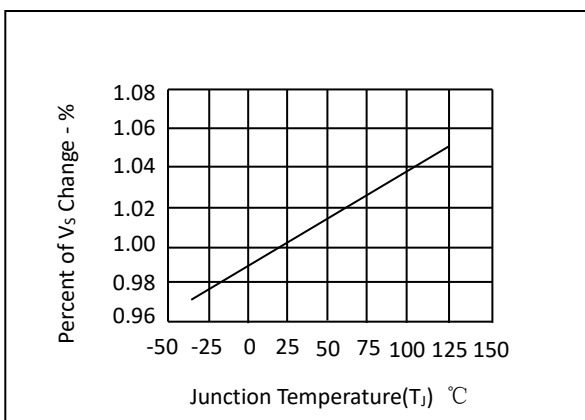

Normalized V_s Change vs. Junction Temperature

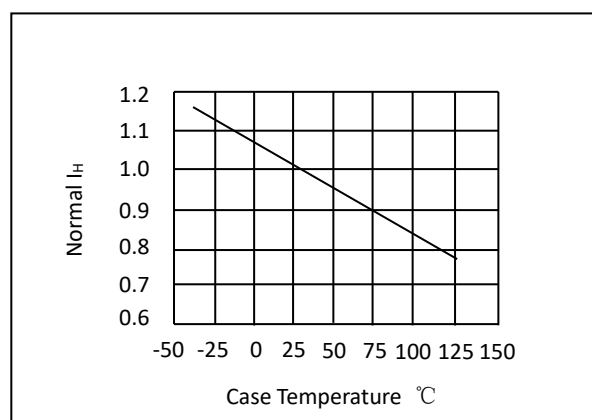

Normalized Holding Current vs. Case Temperature

Soldering Parameters

Reflow Condition		
Pre Heat	Temperature Min ($T_{s(min)}$)	150°C
	Temperature Max ($T_{s(max)}$)	200°C
	Time (min to max) (t_s)	60-190 s
Average ramp up rate (Liquidus Temp) (T_L) to peak		3°C/s max
Ts(max) to T_L - Ramp-up Rate		3°C/s max
Reflow	Temperature (T_L) (Liquidus)	217°C
	Temperature (t_L)	60-150 s
Peak Temperature (T_P)		260 ^{+0/-5} °C
Time within actual peak Temperature (t_p)		20-40 s
Ramp-down Rate		5°C/s max
Time 25°C to peak Temperature (T_P)		8 minutes Max.
Do not exceed		260°C

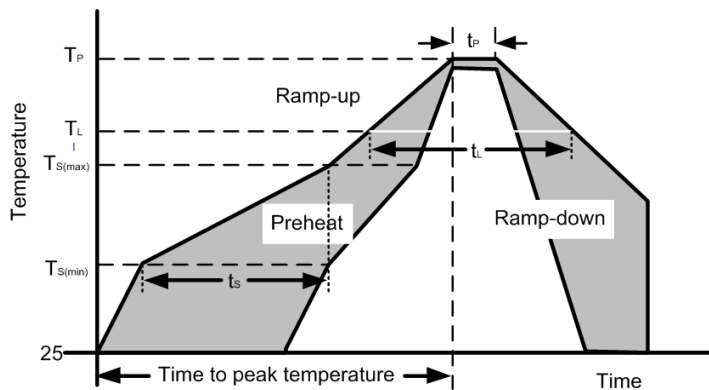

Product Dimensions

Unit: mm

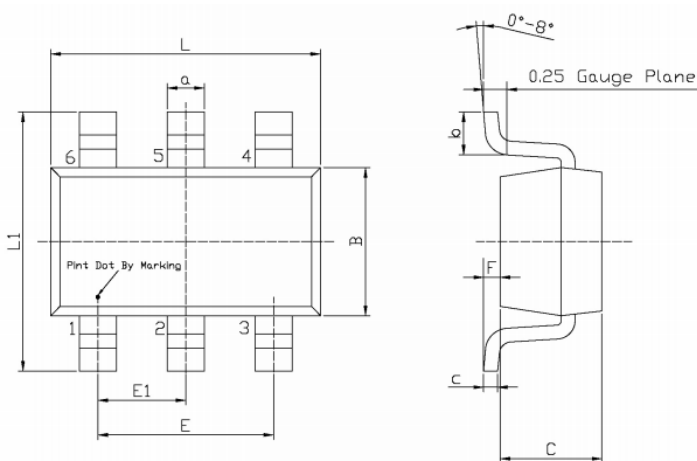

Symbol	Dimensions In Millimeters	
	Min	Max
L	2.82	3.02
B	1.50	1.70
C	0.90	1.30
L1	2.60	3.00
E	1.80	2.00
E1	0.85	1.05
a	0.30	0.50
c	0.10	0.20
b	0.35	0.55
F	0	0.15

Recommended Solder Pad Layout

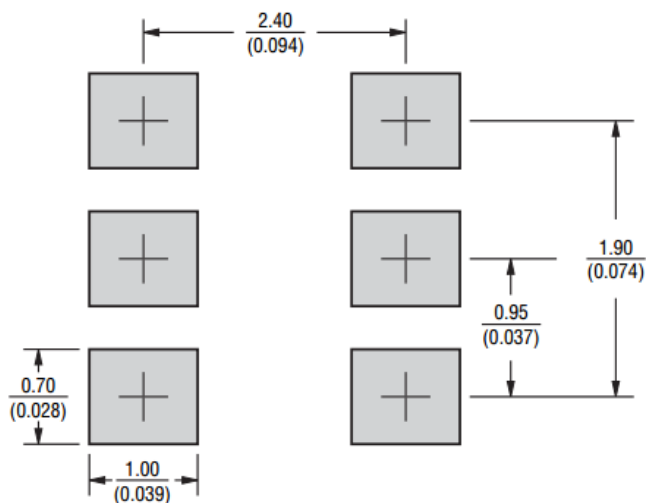

DIMENSIONS = $\frac{\text{MILLIMETERS}}{\text{(INCHES)}}$

Part Numbering System and Marking

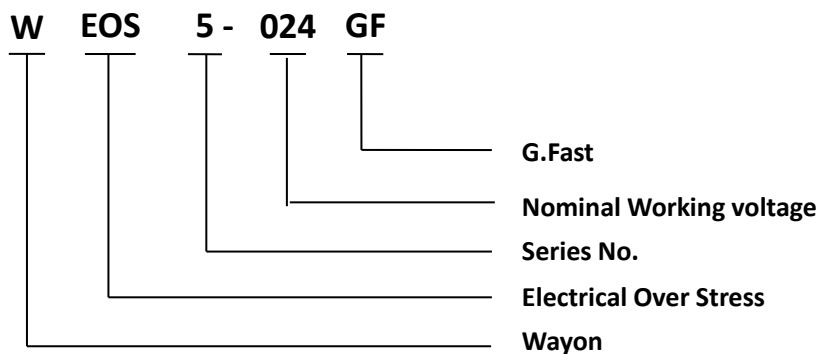

Marking:

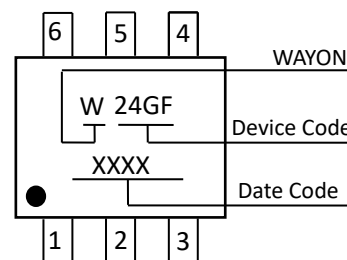

Package Information

Package Type	Description	Quantity (pcs)
SOT23-6	Tape & Reel Pack	3000

Contact Information

No.1001, Shiwan(7) Road, Pudong District, Shanghai, P.R.China.201207

Tel: 021-68969993 Fax: 86-21-50757680 Email: market@way-on.com

WAYON website: <http://www.way-on.com>

For additional information, please contact your local Sales Representative.

WAYON® is registered trademarks of Wayon Corporation.

*Specifications are subject to change without notice.
The device characteristics and parameters in this data sheet can and do vary in different applications and actual device performance may vary over time.
Users should verify actual device performance in their specific applications.*

单击下面可查看定价，库存，交付和生命周期等信息

[>>WAY-ON\(维安\)](#)