

Features

- Solid-state silicon-avalanche technology
- Low operating and clamping voltage
- Up to four I/O Lines of Protection
- Ultra low capacitance: 0.3pF typical(I/O to I/O)
- Low Leakage
- Low operating voltage:5V
- Flow-Through design

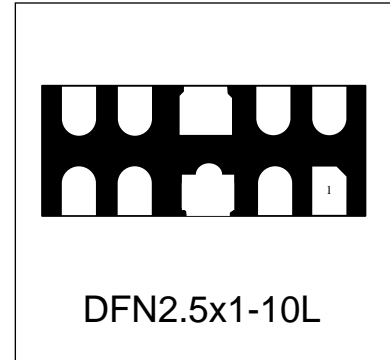

IEC COMPATIBILITY (EN61000-4)

- IEC 61000-4-2 (ESD) $\pm 25\text{kV}$ (air), $\pm 22\text{kV}$ (contact)
- IEC 61000-4-4 (EFT) 40A (5/50ns)
- IEC 61000-4-5 (Lightning) 4.5A (8/20 μs)

Mechanical Characteristics

- DFN-10L package (2.5x1.0x0.50mm)
- Marking: Marking Code
- Packaging: Tape and Reel
- RoHS Compliant

Applications

- Digital Visual Interface(DVI)
- MDDI Ports
- DisplayPort TM Interface
- PCI Express
- High Definition Multi-Media Interface(HDMI)

Circuit Diagram

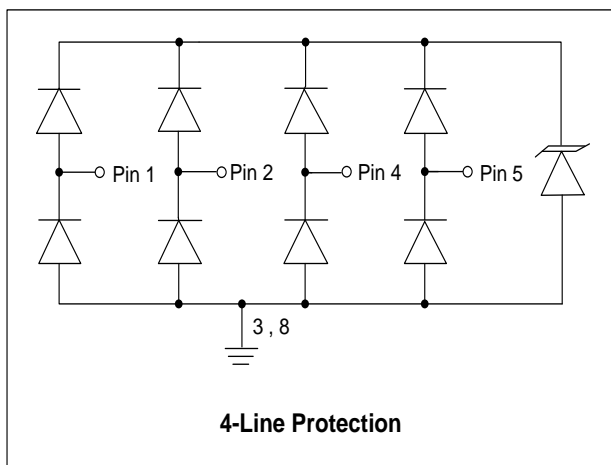

Schematic & PIN Configuration

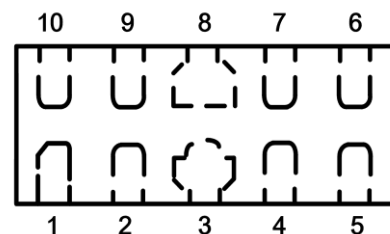

Pin	Identificaion
1,2,4,5	Input Lines
6,7,9,10	Output Lines (No Internal Connection)
3,8	Ground

Absolute Maximum Rating

Rating	Symbol	Value	Units
Peak Pulse Power ($t_p=8/20\mu s$)	P_{PP}	68	Watts
Peak Pulse Current ($t_p=8/20\mu s$)	I_{PP}	4.5	A
Operating Temperature	T_J	-55 to + 125	°C
Storage Temperature	T_{STG}	-55 to +150	°C

Electrical Parameters (T=25°C)

Symbol	Parameter
I_{PP}	Reverse Peak Pulse Current
V_C	Clamping Voltage @ I_{PP}
V_{RWM}	Reverse Stand-Off Voltage
I_R	Reverse Leakage Current @ V_{RWM}
V_{BR}	Breakdown Voltage @ I_T
I_T	Test Current
I_F	Forward Current
V_F	Forward Voltage @ I_F

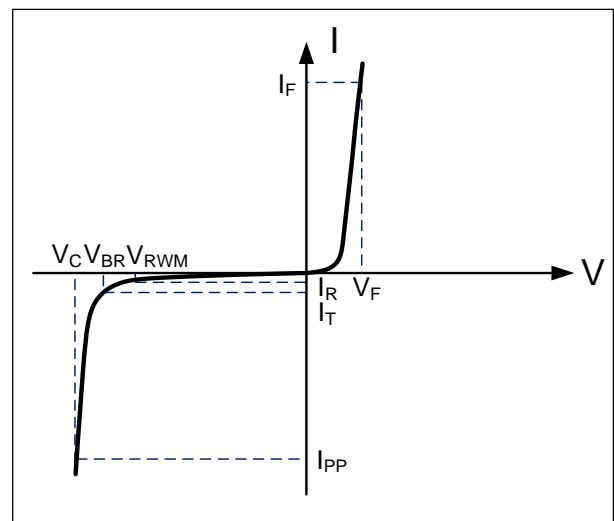

Electrical Characteristics

Parameter	Symbol	Conditions	Minimum	Typical	Maximum	Units
Reverse Stand-Off Voltage	V_{RWM}	Any I/O pin to ground			5	V
Reverse Breakdown Voltage	V_{BR}	$I_T = 1mA$ Any I/O pin to ground	6			V
Reverse Leakage Current	I_R	$V_{RWM} = 5V, T=25^\circ C$ Any I/O pin to ground			500	nA
Clamping Voltage	V_C	$I_{pp}=1A, t_p=8/20\mu s$ Any I/O pin to ground			9	V
Clamping Voltage	V_C	$I_{pp}=4.5A, t_p=8/20\mu s$ Any I/O pin to ground			15	V
Dynamic Resistance ^{1,2}	R_{DYN}	TLP=0.2/100ns		0.5		Ω
ESD Clamping Voltage ¹	V_C	IPP = 4A, $t_p = 0.2/100ns$ (TLP)		10		V
ESD Clamping Voltage ¹	V_C	IPP = 16A, $t_p = 0.2/100ns$ (TLP)		16		V
Junction Capacitance	C_j	$V_R = 0V, f = 1MHz$ I/O pin to GND			0.8	pF
		$V_{Pin3,8}=0V, V_R = 0V,$ $f = 1MHz$ Between I/O pins		0.3	0.4	pF

Notes : 1、 TLP Setting : $t_p=100ns, t_r=0.2ns, I_{TLP}$ and V_{TLP} sample window: $t_1=70ns$ to $t_2=90ns$.
 2、 Dynamic resistance calculated from $I_{PP}=4A$ to $I_{PP}=16A$ using "Best Fit".

Typical Characteristics

Figure 1: Peak Pulse Power vs. Pulse Time

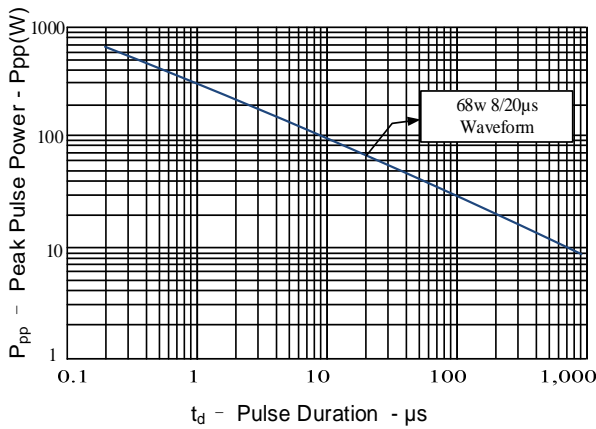

Figure 2: Power Derating Curve

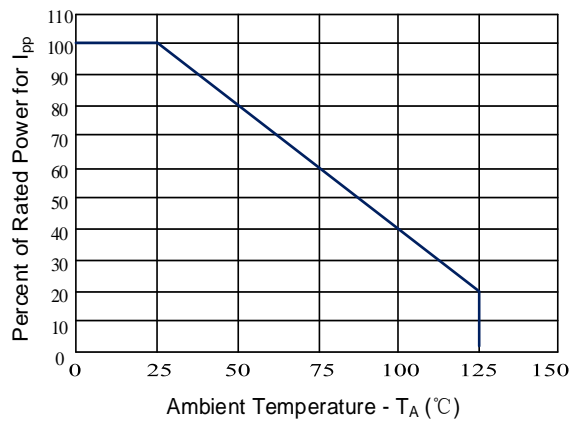

Figure 3: Clamping Voltage vs. Peak Pulse Current

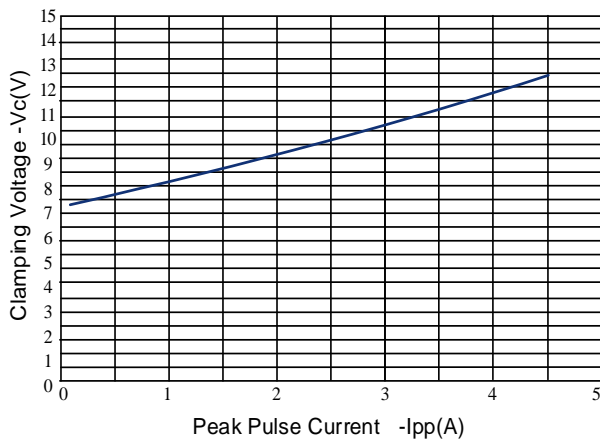

Figure 4: Normalized Junction Capacitance vs. Reverse Voltage

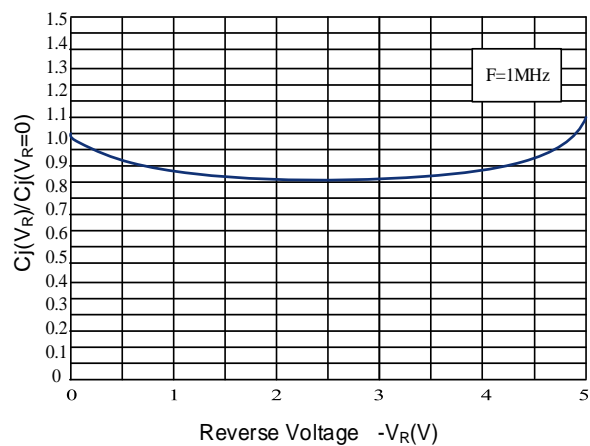

Figure 5: 8/20μs Pulse Waveform

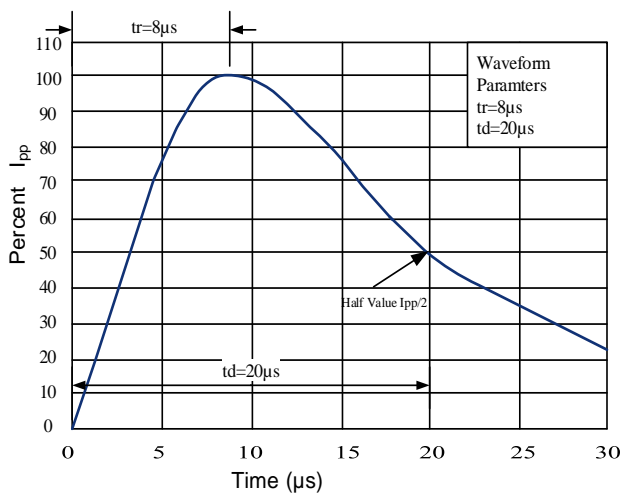
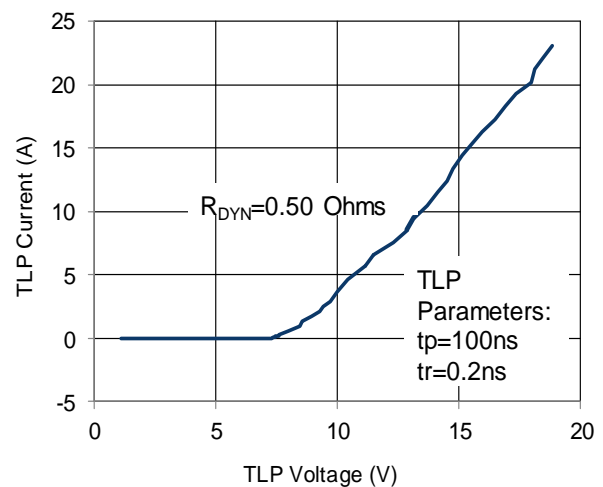
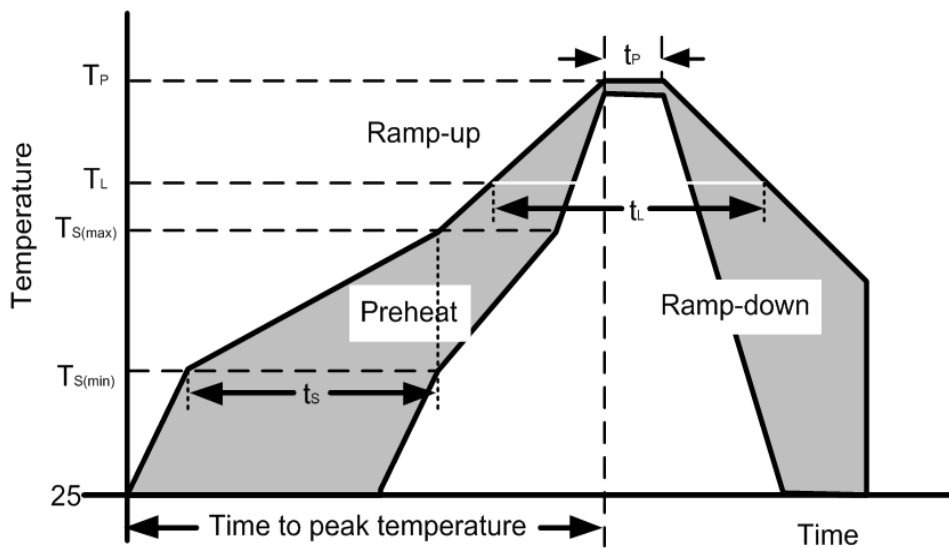

Figure 6: TLP I-V Curve



Soldering Parameters

Reflow Condition		Pb – Free assembly
Pre Heat	Temperature Min ($T_{S(min)}$)	150°C
	Temperature Max ($T_{S(max)}$)	200°C
	Time (min to max) (t_s)	60 – 190 secs
Average ramp up rate (Liquidus Temp) (T_L) to peak		5°C/second max
$T_{S(max)}$ to T_L — Ramp-up Rate		5°C/second max
Reflow	Temperature (T_L) (Liquidus)	217°C
	Temperature (t_L)	60 – 150 seconds
Peak Temperature (T_P)		260+0/-5 °C
Time within actual peak Temperature (t_p)		20 – 40 seconds
Ramp-down Rate		5°C/second max
Time 25°C to peak Temperature (T_P)		8 minutes Max.
Do not exceed		280°C



Outline Drawing –DFN2510-10L

DFN2.5x1-10L

DIMENSIONS

DIM	INCHES			MILLIMETERS		
	MIN	NOM	MAX	MIN	NOM	MAX
A	0.018	0.020	0.022	0.45	0.50	0.55
A1	0.000	0.001	0.002	0.00	0.02	0.05
A2	0.006			0.15		
b	0.006	0.008	0.010	0.15	0.20	0.25
b1	0.014	0.016	0.018	0.35	0.40	0.45
b2	0.008	0.010	0.018	0.20	0.25	0.45
D	0.096	0.098	0.100	2.45	2.50	2.55
E	0.037	0.039	0.041	0.95	1.00	1.05
e	0.020 BSC			0.50 BSC		
L	0.014	0.016	0.018	0.35	0.40	0.45
L1	0.000	0.003	0.004	0.00	0.075	0.10
L2	0.000	0.002	0.003	0.00	0.05	0.08
h	0.000	0.005	0.006	0.00	0.12	0.15
N	8			8		
N1	2			2		

DIMENSIONS		
DIM	INCHES	MILLIMETERS
C	0.034	0.875
G	0.008	0.20
P	0.020	0.50
P1	0.039	1.00
X	0.010	0.25
X1	0.018	0.45
Y	0.027	0.675
Y1	0.061	1.55

Notes:
Controlling Dimension: Millimeter.

Marking Codes

Part Number	WS05-4R2P
Marking Code	5R2P

Package Information

Qty: 3k/Reel

CONTACT INFORMATION

No.1001, Shiwan (7) Road, Pudong District, Shanghai, P.R.China.201207

Tel: 86-21-68969993 Fax: 86-21-50757680 Email: market@way-on.com

WAYON website: <http://www.way-on.com>

For additional information, please contact your local Sales Representative.

WAYON ® is registered trademark of Wayon Corporation.

Specifications are subject to change without notice.
The device characteristics and parameters in this data sheet can and do vary in different applications and actual device performance may vary over time.
Users should verify actual device performance in their specific applications.

单击下面可查看定价，库存，交付和生命周期等信息

[>>WAY-ON\(维安\)](#)