

Transient Voltage Suppressor

Features

- Array of surge rated diodes with internal TVS Diode
- Provides protection for two differential data pairs(4 channels)
- Low capacitance
- Low leakage current and clamping voltage
- Low operating voltage: 2.5V

IEC COMPATIBILITY (EN61000-4)

- IEC 61000-4-2 (ESD) $\pm 30\text{kV}$ (air), $\pm 30\text{kV}$ (contact)
- IEC 61000-4-4 (EFT) 40A (5/50ns)
- IEC 61000-4-5 (Lightning) 40A (8/20 μs)

Mechanical Characteristics

- DFN3020-10L package
- Marking: Marking Code
- Packaging: Tape and Reel
- RoHS Compliant

Applications

- Automotive
- 10/100/1000 Ethernet
- Digital Visual Interface (DVI)
- T1/E1 Secondary Protection
- LVDS Interfaces
- Analog Video

Circuit Diagram

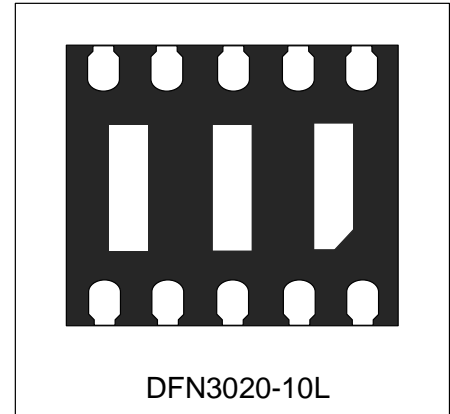
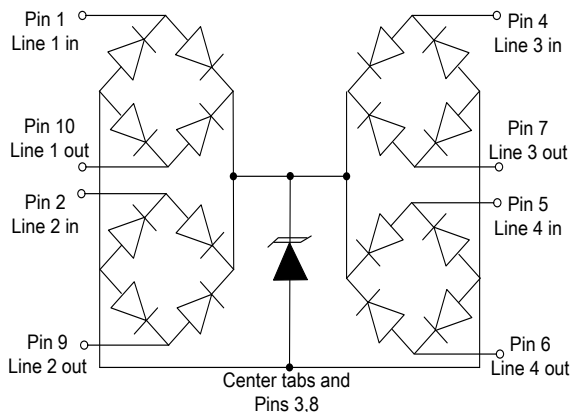

Package Configuration

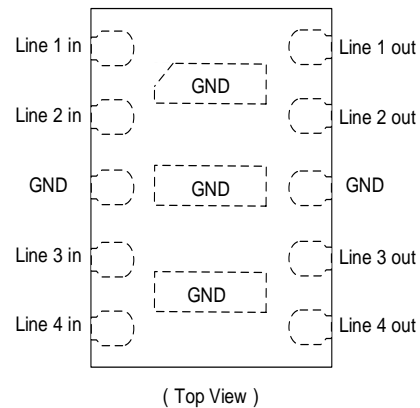

Absolute Maximum Rating

Rating	Symbol	Value	Units
Peak Pulse Power ($t_p = 8/20\mu s$)	P_{PP}	860	Watts
Peak Pulse Current ($t_p = 8/20\mu s$)	I_{pp}	40	A
Operating Temperature	T_J	-55 to + 125	°C
Storage Temperature	T_{STG}	-55 to +150	°C

Electrical Parameters (T=25°C)

Symbol	Parameter
I_{PP}	Reverse Peak Pulse Current
V_C	Clamping Voltage @ I_{PP}
V_{RWM}	Reverse Stand-Off Voltage
I_R	Reverse Leakage Current @ V_{RWM}
V_{PT}	Punch-through Voltage @ I_T
V_{SB}	Snap-Back Voltage @ I_{SB}
I_{SB}	Snap-Back Current
I_{PT}	Punch-through Current
V_{PTF}	Forward Punch-through Voltage @ I_{PTF}
I_{PTF}	Forward Punch-through Current

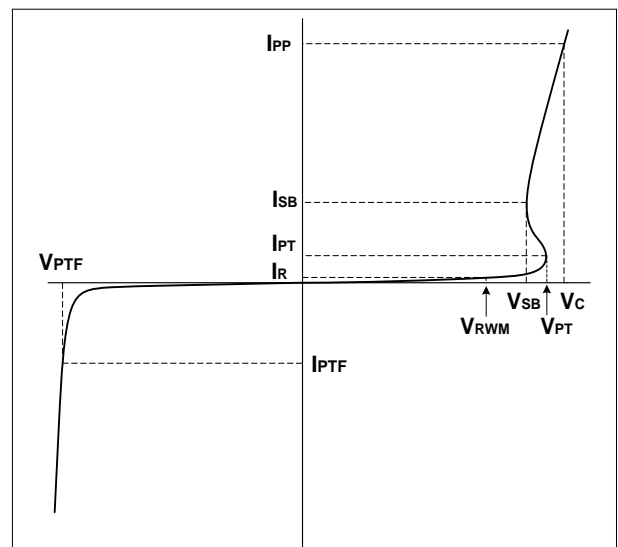

Electrical Characteristics

WS2.5-4R7NS						
Parameter	Symbol	Conditions	Min	Typ	Max	Units
Reverse Stand-Off Voltage	V_{RWM}				2.5	V
Punch-through Voltage	V_{PT}	$I_{PT} = 2\mu A$	3			V
Snap-Back Voltage	V_{SB}	$I_{SB} = 50mA$	2.7			V
Reverse Leakage Current	I_R	$V_{RWM} = 2.5V, T=25^\circ C$			500	nA
Clamping Voltage	V_C	$I_{pp}=25A, t_p=8/20\mu s$ Any I/O pin to ground			11.5	V
Clamping Voltage ¹	V_C	$I_{pp}=40A, t_p=8/20\mu s$ Line-to-Line, two I/O Pins connected together on each line			21.5	V
ESD Clamping Voltage ²	V_C	$I_{PP} = 4A$ $t_p = 0.2/100ns$		6.5		V
ESD Clamping Voltage ²	V_C	$I_{PP} = 16A$ $t_p = 0.2/100ns$		8.9		V
Dynamic Resistance ^{2,3}	R_{DYN}	TLP=0.2/100ns		0.2		Ω
Junction Capacitance	C_j	$V_R = 0V, f = 1MHz$ I/O pin to GND		3.6	5	pF
		$V_R = 0V, f = 1MHz$ Between I/O pins		1.5	2.5	pF

Notes:1) Ratings with 2 pins connected together per the recommended configuration (ie pin 1 connected to pin 10, pin 2 connected to pin 9, pin 4 connected to pin 7, and pin 5 connected to pin 6).

2) TLP Setting : $t_p=100ns, t_r=0.2ns, I_{TLP}$ and V_{TLP} sample window: $t_1=70ns$ to $t_2=90ns$.

3) Dynamic resistance calculated from $I_{PP}=4A$ to $I_{PP}=16A$ using "Best Fit"

Typical Characteristics

Figure 1: Peak Pulse Power vs. Pulse Time

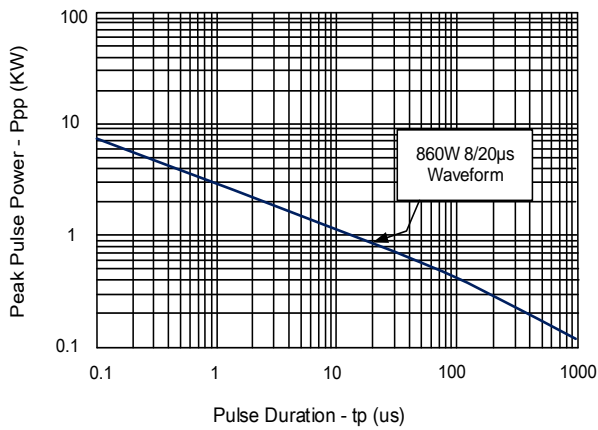

Figure 2: Power Derating Curve

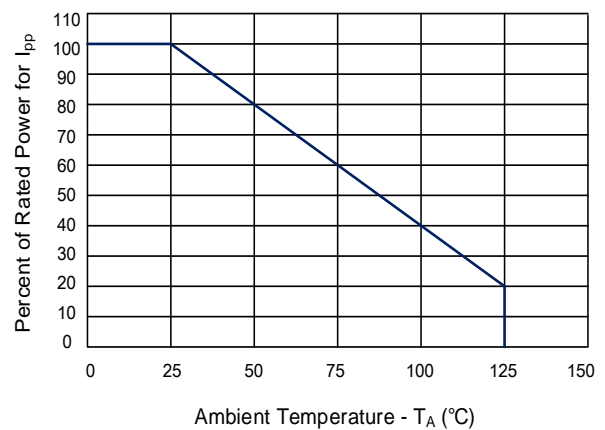

Figure 3: Clamping Voltage vs. Peak Pulse Current

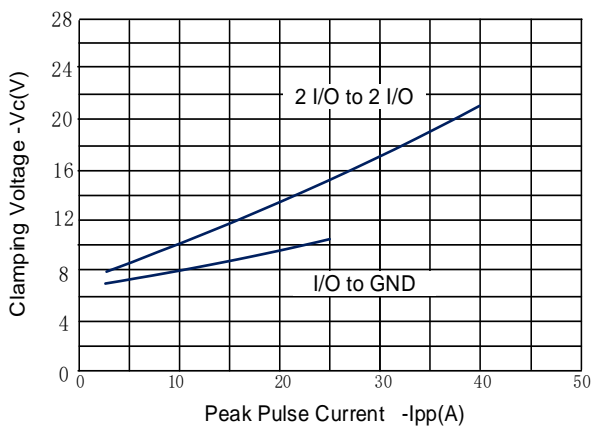

Figure 4: Normalized Junction Capacitance vs. Reverse Voltage (I/O to GND)

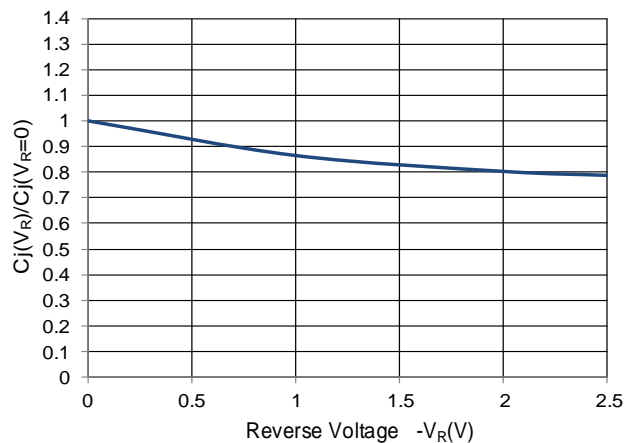

Figure 5: 8/20us Pulse Waveform

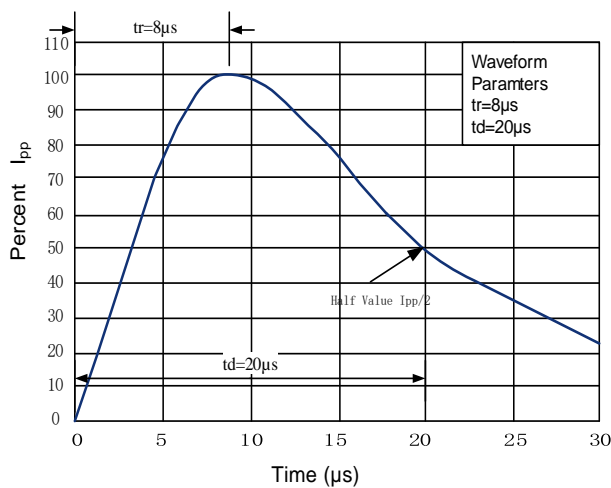
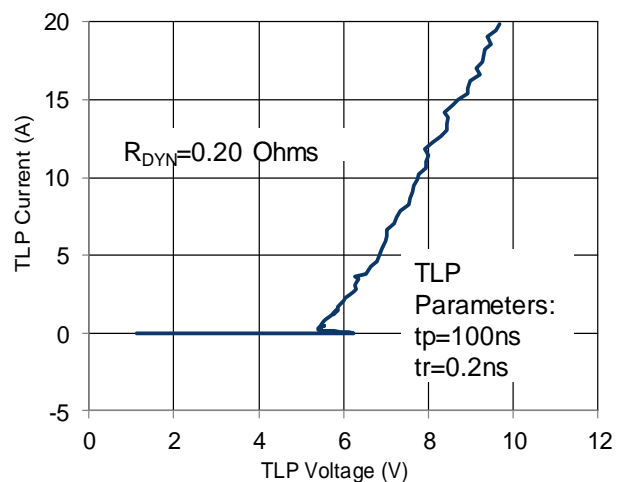
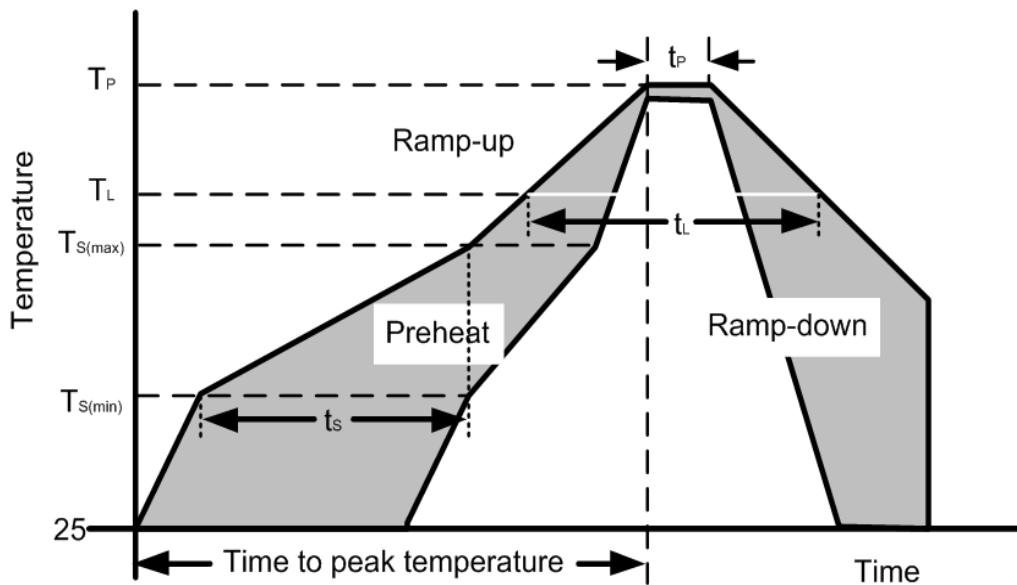

Figure 6: TLP I-V Curve



Soldering Parameters

Reflow Condition		Pb – Free assembly
Pre Heat	Temperature Min ($T_{S(min)}$)	150°C
	Temperature Max ($T_{S(max)}$)	200°C
	Time (min to max) (t_s)	60 – 190 secs
Average ramp up rate (Liquidus Temp) (T_L) to peak		5°C/second max
$T_{S(max)}$ to T_L —Ramp-up Rate		5°C/second max
Reflow	Temperature (T_L) (Liquidus)	217°C
	Temperature (t_L)	60 – 150 seconds
Peak Temperature (T_P)		260+0/-5 °C
Time within actual peak Temperature (t_p)		20 – 40 seconds
Ramp-down Rate		5°C/second max
Time 25°C to peak Temperature (T_P)		8 minutes Max.
Do not exceed		280°C



Outline Drawing –DFN3020-10L

TOP VIEW

BOTTOM VIEW

SIDE VIEW

PIN 1 INDICATOR (LASER MARK)

DFN3020-10L

DIMENSIONS			
SYMBOL	MILLIMETERS		
	MIN	NOM	MAX
D	2.90	3.00	3.10
E	1.90	2.00	2.10
D2	0.30	0.35	0.40
E2	0.95	1.00	1.05
A	0.50	0.55	0.60
A1	0.00	0.02	0.05
C	0.15REF		
b	0.15	0.20	0.25
b1	0.14REF		
e	0.60BSC		
e1	0.65BSC		
e2	0.95BSC		
L	0.25	0.30	0.35
h	0.10	0.15	0.20

Land Pattern

DIMENSIONS	
DIM	MILLIMETERS
C	1.80
G	1.40
P	0.60
P1	0.65
P2	0.95
X	0.25
X1	0.40
Y	0.40
Y1	1.00
Z	2.20

NOTES:

Controlling Dimension: Millimeter.

Marking Codes

Part Number	Marking Code	
WS2.5-4R7NS	220425 YYWW	220425=Marking Code YYWW=Date Code

Package Information

Qty: 3k/Reel

CONTACT INFORMATION

No.1001, Shiwan (7) Road, Pudong District, Shanghai, P.R.China.201207

Tel: 86-21-68969993 Fax: 86-21-50757680 Email: market@way-on.com

WAYON website: <http://www.way-on.com>

For additional information, please contact your local Sales Representative.

WAYON® is registered trademark of Wayon Corporation.

Specifications are subject to change without notice.
The device characteristics and parameters in this data sheet can and do vary in different applications and actual device performance may vary over time.
Users should verify actual device performance in their specific applications.

单击下面可查看定价，库存，交付和生命周期等信息

[>>WAY-ON\(维安\)](#)