

Features

- 910 Watts Peak Pulse Power per Line ($t_p=8/20\mu s$)
- Small Body Outline Dimensions
- Protects one I/O or power line
- Working Voltage: 18V
- Low Leakage Current

IEC COMPATIBILITY (EN61000-4)

- IEC 61000-4-2 (ESD) $\pm 30kV$ (air), $\pm 30kV$ (contact)
- IEC 61000-4-4 (EFT) 40A (5/50ns)
- IEC 61000-4-5 (Lightning) 26A (8/20 μs)

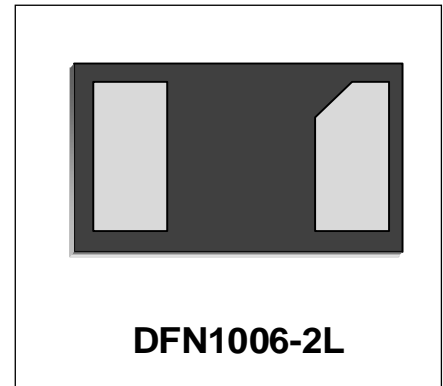

Mechanical Characteristics

- DFN1006-2L package
- Marking : Marking Code
- Packaging : Tape and Reel per EIA 481
- RoHS Compliant

Applications

- Cellular Handsets & Accessories
- Personal Digital Assistants (PDAs)
- Notebooks & Handhelds
- Portable Instrumentation
- Digital Cameras

Schematic & PIN Configuration

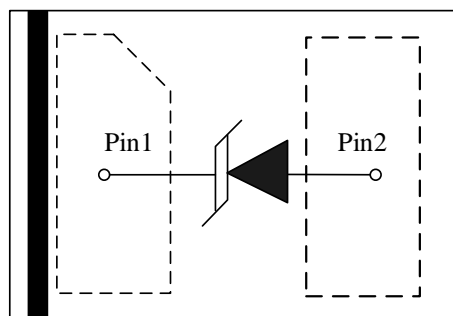

(TOP VIEW)

Absolute Maximum Rating			
Rating	Symbol	Value	Units
Peak Pulse Power ($t_p = 8/20\mu s$)	P _{PP}	910	Watts
Peak Pulse Current ($t_p = 8/20\mu s$)	I _{PP}	26	A
Operating Temperature	T _J	-55 to +125	°C
Storage Temperature	T _{STG}	-55 to +150	°C

Electrical Parameters (T=25°C)

Symbol	Parameter
I _{PP}	Reverse Peak Pulse Current
V _C	Clamping Voltage @ I _{PP}
V _{RWM}	Reverse Stand-Off Voltage
I _R	Reverse Leakage Current @ V _{RWM}
V _{BR}	Breakdown Voltage @ I _T
I _T	Test Current
I _F	Forward Current
V _F	Forward Voltage @ I _F

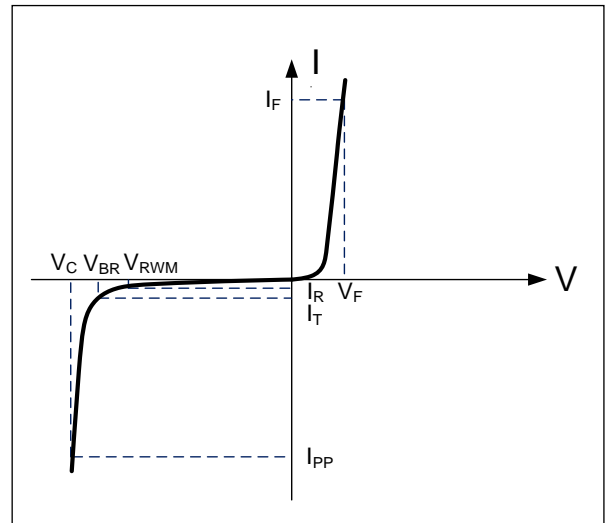

Electrical Characteristics

WS18DFVXM						
Parameter	Symbol	Conditions	Minimum	Typical	Maximum	Units
Reverse Stand-Off Voltage	V _{RWM}				18	V
Reverse Breakdown Voltage	V _{BR}	I _T =1mA	19		23	V
Reverse Leakage Current	I _R	V _{RWM} =18V, T=25°C			500	nA
Forward Voltage	V _F	I _F =10mA	0.5		1.2	V
Clamping Voltage	V _C	I _{PP} =26A, t _p =8/20μs		31	35	V
Dynamic Resistance ^{1,2}	R _{DYN}	TLP=0.2/100ns		0.14		Ω
ESD Clamping Voltage ¹	V _C	I _{PP} = 4A, t _p = 0.2/100ns (TLP)		21		V
ESD Clamping Voltage ¹	V _C	I _{PP} = 16A, t _p = 0.2/100ns (TLP)		22.7		V
Junction Capacitance	C _j	V _R = 0V, f = 1MHz		135	180	pF

Note: 1. TLP Setting : t_p=100ns, t_r=0.2ns, I_{TLP} and V_{TLP} sample window:t₁=70ns to t₂=90ns.
 2. Dynamic resistance calculated from I_{PP}=4A to I_{PP}=16A using "Best Fit"

Typical Characteristics

Figure 1: Peak Pulse Power vs. Pulse Time

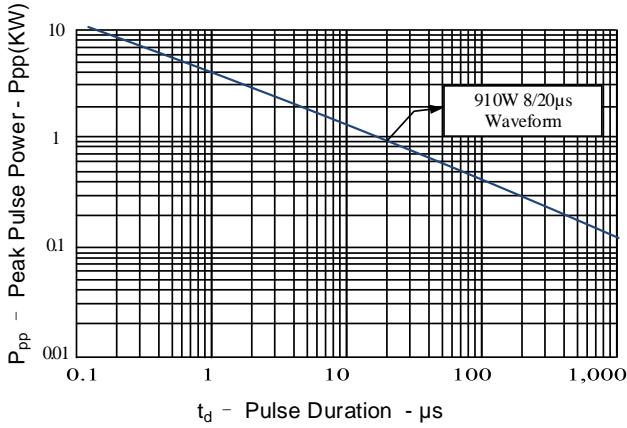

Figure 2: Power Derating Curve

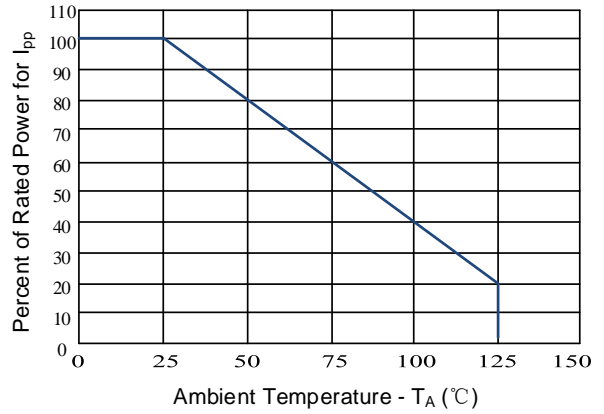

Figure 3: Clamping Voltage vs. Peak Pulse Current

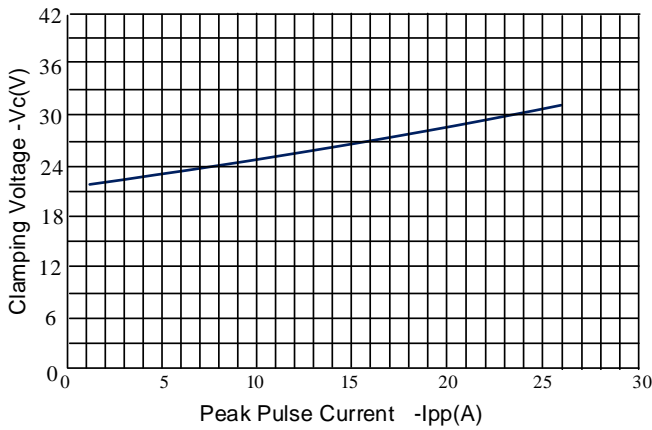

Figure 4: Normalized Junction Capacitance vs. Reverse Voltage

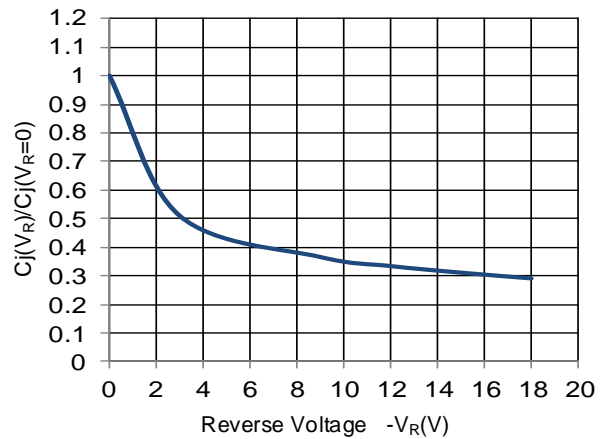

Figure 5: 8/20μs Pulse Waveform

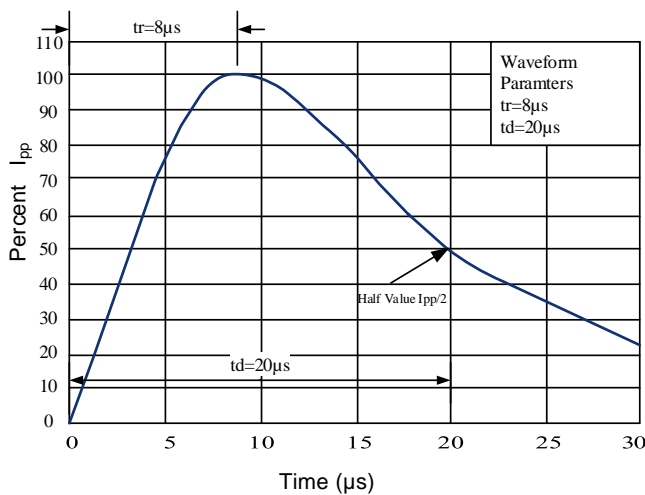
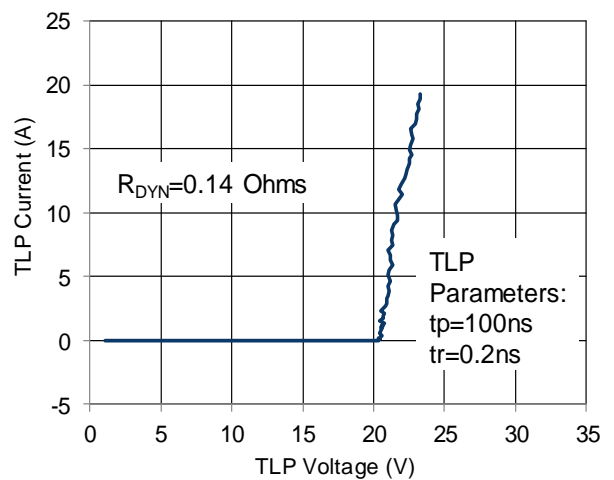
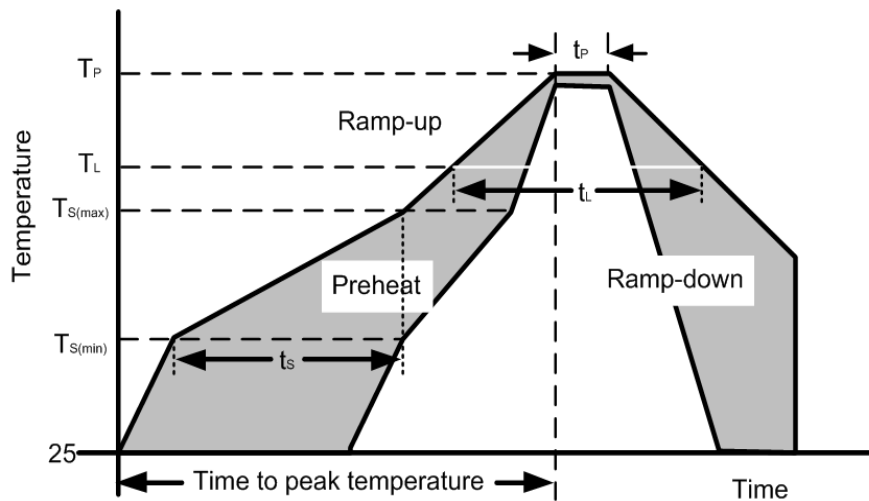

Figure 6: TLP Curve



Soldering Parameters

Reflow Condition		Pb – Free assembly
Pre Heat	Temperature Min ($T_{s(min)}$)	150°C
	Temperature Max ($T_{s(max)}$)	200°C
	Time (min to max) (t_s)	60 – 190 secs
Average ramp up rate (Liquidus Temp) (T_L) to peak		5°C/second max
$T_{s(max)}$ to T_L —Ramp-up Rate		5°C/second max
Reflow	Temperature (T_L) (Liquidus)	217°C
	Temperature (t_L)	60 – 150 seconds
Peak Temperature (T_P)		260+0/-5 °C
Time within actual peak Temperature (t_p)		20 – 40 seconds
Ramp-down Rate		5°C/second max
Time 25°C to peak Temperature (T_P)		8 minutes Max.
Do not exceed		280°C



Outline Drawing –DFN1006-2L

PACKAGE OUTLINE

DFN1006-2L

SYMBOL	MILLIMETERS			Dimension In Inches		
	NOM	MIN	MAX	NOM	MIN	MAX
A	--	0.35	0.400	--	0.014	0.016
A1	--	--	0.055	--	--	0.002
D	1.000	0.950	1.050	0.039	0.037	0.041
E	0.600	0.550	0.650	0.024	0.022	0.026
b	0.480	0.430	0.530	0.019	0.017	0.021
L	0.220	0.170	0.270	0.009	0.007	0.011
h	0.125	0.075	0.175	0.005	0.003	0.007
L1	0.065REF			0.003REF		
L2	0.060REF			0.002REF		
e	0.650BSC			0.026BSC		

Land Pattern

Marking Codes

Part Number	Marking Code
WS18DFVXM	<div style="display: flex; align-items: center; justify-content: center;"> 1 <div style="border: 1px solid black; padding: 5px; text-align: center;"> </div> 2 </div> <p style="font-size: small; margin-top: 5px;">SV=Specific Device Code X=Month Code</p>

Package Information

Qty: 10k/Reel

CONTACT INFORMATION

No.1001, Shiwan (7) Road, Pudong District, Shanghai, P.R.China.201207
 Tel: 86-21-68969993 Fax: 86-21-50757680 Email: market@way-on.com
 WAYON website: <http://www.way-on.com>
 For additional information, please contact your local Sales Representative.

WAYON ® is registered trademark of Wayon Corporation.

*Specifications are subject to change without notice.
 The device characteristics and parameters in this data sheet can and do vary in different applications and actual device performance may vary over time.
 Users should verify actual device performance in their specific applications.*

单击下面可查看定价，库存，交付和生命周期等信息

[>>WAY-ON\(维安\)](#)