

## Power Transient Voltage Suppressor

### Features

- 400 watts Peak Pulse Power (10/1000 $\mu$ s)
- Unidirectional and Bidirectional Protection
- Fast Response Time: Typically < 1ns
- Excellent Clamping Capability
- Low incremental surge resistance
- Plastic package has Underwriters Laboratory Flammability classification 94V-0
- High temperature soldering guaranteed:260 $^{\circ}$ C/10 seconds/.375", (9.5mm) lead length/5lbs., (2.3kg) tension

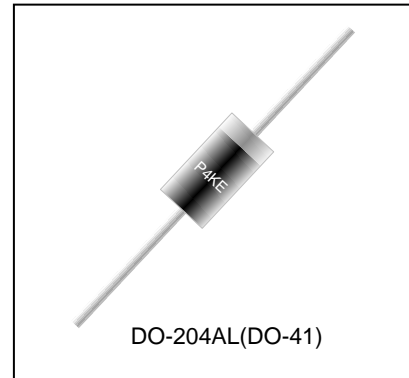

### Mechanical Characteristics

- JEDEC DO-204AL molded plastic
- Polarity: Color band denoted cathode except Bipolar
- Marking: Marking Code
- Mounting Position: Any
- RoHS &UL497B Compliant

### Applications

- I/O Interfaces
- Power lines
- Telecommunication
- Consumer electronic
- Industrial Electronics
- Computer

Absolute Maximum Rating			
Rating	Symbol	Value	Units
Peak Pulse Power ( $t_p = 10/1000\mu s$ ) (see Note1)	$P_{PPM}$	400	Watts
Peak pulse current (10/1000 $\mu s$ ) (see Note1)	$I_{PPM}$	See Electrical Characteristics	A
Peak Forward surge current (see Note2)	$I_{FSM}$	40	A
Power Dissipation on infinite heat sink $T_L = 50^{\circ}C$ (Fig5)	$P_D$	1.5	W
Operating Junction Temperature range	$T_J$	-55 to + 175	$^{\circ}C$
Typical Thermal Resistance Junction to Lead	$R_{uJL}$	60	$^{\circ}C/W$

**Note1:** Non-repetitive current pulse, per Fig.3 and derated above  $T_A=25^{\circ}C$  per Fig.2.

**Note2:** Measured on 8.3ms single half sine wave or equivalent square wave, duty cycle=4 per minute maximum.

**Note3:**  $V_F < 3.5V$  for devices of  $V_{BR} \leq 200V$  and  $V_F < 5.0V$  for devices of  $V_{BR} \geq 201V$ .

## Electrical Characteristics

Part Number		Reverse Stand off Voltage $V_{RWM}$ (Volts)	Breakdown Voltage		Test Current $I_T$ (mA)	Maximum Clamping Voltage $V_C@I_{PP}$ (Volts)	Maximum Peak Pulse Current $I_{PP}$ (Amps)	Maximum Reverse Leakage $I_R@V_{RWM}$ ( $\mu$ A)
			$V_{BR}(\text{Volts})@I_T$					
UNI-POLAR	BI-POLAR		MIN	MAX				
P4KE6.8A	P4KE6.8CA	5.80	6.45	7.14	10	10.5	39.0	1000
P4KE7.5A	P4KE7.5CA	6.40	7.13	7.88	10	11.3	36.3	500
P4KE8.2A	P4KE8.2CA	7.02	7.79	8.61	10	12.1	33.9	200
P4KE9.1A	P4KE9.1CA	7.78	8.65	9.55	1	13.4	30.6	50
P4KE10A	P4KE10CA	8.55	9.50	10.50	1	14.5	28.3	10
P4KE11A	P4KE11CA	9.40	10.50	11.60	1	15.6	26.3	5
P4KE12A	P4KE12CA	10.20	11.40	12.60	1	16.7	24.6	5
P4KE13A	P4KE13CA	11.10	12.40	13.70	1	18.2	22.5	1
P4KE15A	P4KE15CA	12.80	14.30	15.80	1	21.2	19.3	1
P4KE16A	P4KE16CA	13.60	15.20	16.80	1	22.5	18.2	1
P4KE18A	P4KE18CA	15.30	17.10	18.90	1	25.5	16.1	1
P4KE20A	P4KE20CA	17.10	19.00	21.00	1	27.7	14.8	1
P4KE22A	P4KE22CA	18.80	20.90	23.10	1	30.6	13.4	1
P4KE24A	P4KE24CA	20.50	22.80	25.20	1	33.2	12.3	1
P4KE27A	P4KE27CA	23.10	25.70	28.40	1	37.5	10.9	1
P4KE30A	P4KE30CA	25.60	28.50	31.50	1	41.4	9.9	1
P4KE33A	P4KE33CA	28.20	31.40	34.70	1	45.7	9.0	1
P4KE36A	P4KE36CA	30.80	34.20	37.80	1	49.9	8.2	1
P4KE39A	P4KE39CA	33.30	37.10	41.00	1	53.9	7.6	1
P4KE43A	P4KE43CA	36.80	40.90	45.20	1	59.3	6.9	1
P4KE47A	P4KE47CA	40.20	44.70	49.40	1	64.8	6.3	1
P4KE51A	P4KE51CA	43.60	48.50	53.60	1	70.1	5.8	1
P4KE56A	P4KE56CA	47.80	53.20	58.80	1	77.0	5.3	1
P4KE62A	P4KE62CA	53.00	58.90	65.10	1	85.0	4.8	1
P4KE68A	P4KE68CA	58.10	64.60	71.40	1	92.0	4.5	1
P4KE75A	P4KE75CA	64.10	71.30	78.80	1	103.0	4.0	1

## Electrical Characteristics (Cont.)

Part Number		Reverse Stand off Voltage $V_{RWM}$ (Volts)	Breakdown Voltage		Test Current $I_T$ (mA)	Maximum Clamping Voltage $V_C@I_{PP}$ (Volts)	Maximum Peak Pulse Current $I_{PP}$ (Amps)	Maximum Reverse Leakage $I_R@V_{RWM}$ ( $\mu$ A)
			$V_{BR}(\text{Volts})@I_T$					
UNI-POLAR	BI-POLAR		MIN	MAX				
P4KE82A	P4KE82CA	70.10	77.90	86.10	1	113.0	3.6	1
P4KE91A	P4KE91CA	77.80	86.50	95.50	1	125.0	3.3	1
P4KE100A	P4KE100CA	85.50	95.00	105.00	1	137.0	3.0	1
P4KE110A	P4KE110CA	94.00	105.00	116.00	1	152.0	2.7	1
P4KE120A	P4KE120CA	102.00	114.00	126.00	1	165.0	2.5	1
P4KE130A	P4KE130CA	111.00	124.00	137.00	1	179.0	2.3	1
P4KE150A	P4KE150CA	128.00	143.00	158.00	1	207.0	2.0	1
P4KE160A	P4KE160CA	136.00	152.00	168.00	1	219.0	1.9	1
P4KE170A	P4KE170CA	145.00	162.00	179.00	1	234.0	1.8	1
P4KE180A	P4KE180CA	154.00	171.00	189.00	1	246.0	1.7	1
P4KE200A	P4KE200CA	171.00	190.00	210.00	1	274.0	1.5	1
P4KE220A	P4KE220CA	185.00	209.00	231.00	1	328.0	1.3	1
P4KE250A	P4KE250CA	214.00	237.00	263.00	1	344.0	1.2	1
P4KE300A	P4KE300CA	256.00	285.00	315.00	1	414.0	1.0	1
P4KE350A	P4KE350CA	300.00	332.00	368.00	1	482.0	0.85	1
P4KE400A	P4KE400CA	342.00	380.00	420.00	1	548.0	0.75	1
P4KE440A	P4KE440CA	376.00	418.00	462.00	1	602.0	0.68	1
P4KE480A	P4KE480CA	408.00	456.00	504.00	1	658.0	0.61	1
P4KE510A	P4KE510CA	434.00	485.00	535.00	1	698.0	0.57	1
P4KE530A	P4KE530CA	477.00	503.50	556.50	1	725.0	0.55	1
P4KE540A	P4KE540CA	486.00	513.00	567.00	1	740.0	0.54	1
P4KE550A	P4KE550CA	495.00	522.50	577.50	1	760.0	0.52	1

For bidirectional type VR of 10 volts and less, the IR limit is double.

For parts without A, the VBR is  $\pm 10\%$  and VC is 5% higher than with A parts.

Typical Characteristics

Figure 1: Peak Pulse Power Rating Curve

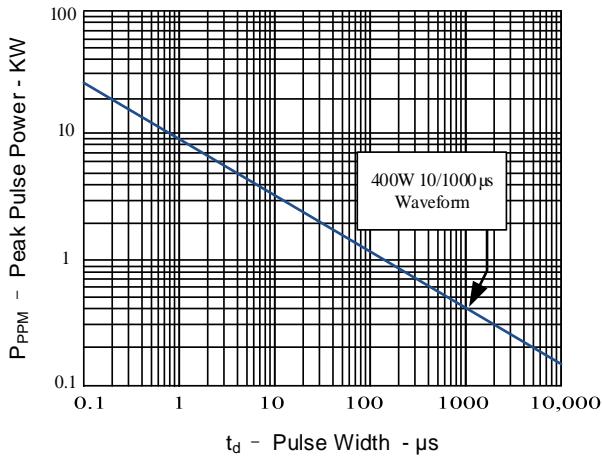

Figure 2: Pulse Derating Curve

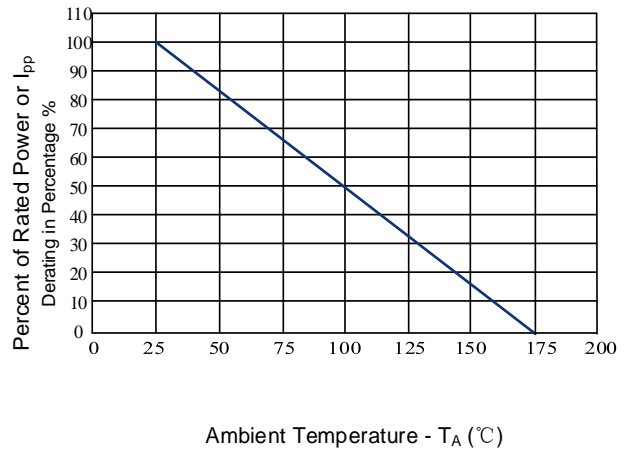

Figure 3: Pulse Waveform

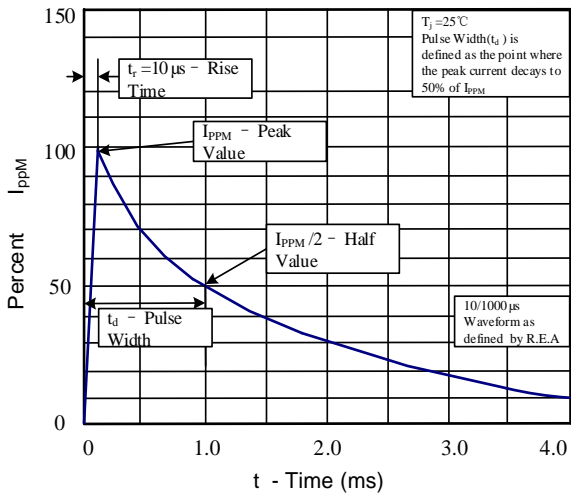

Figure 4: Typical Junction Capacitance

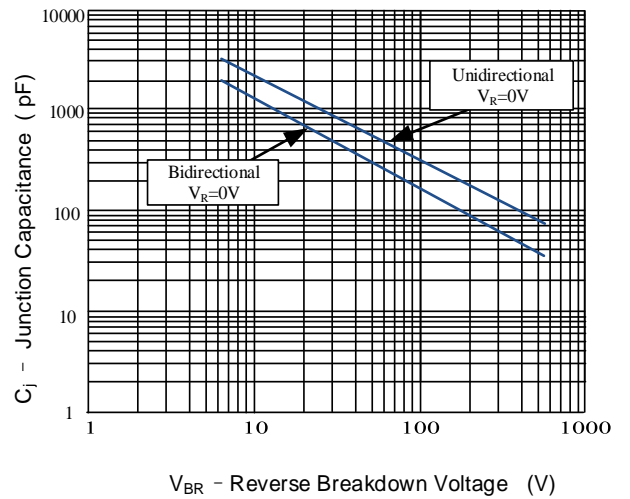

Figure 5: Steady State Power Dissipation Derating Curve

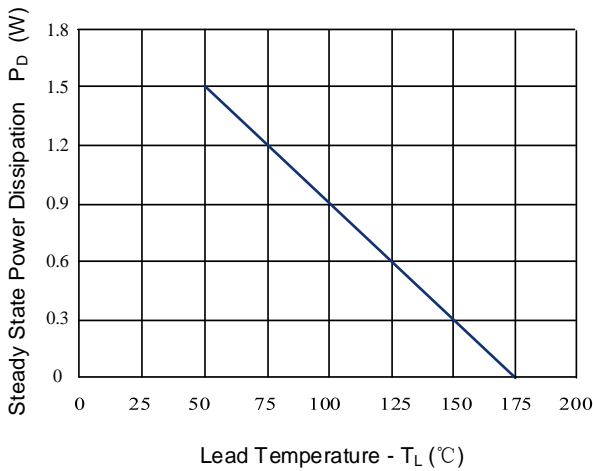
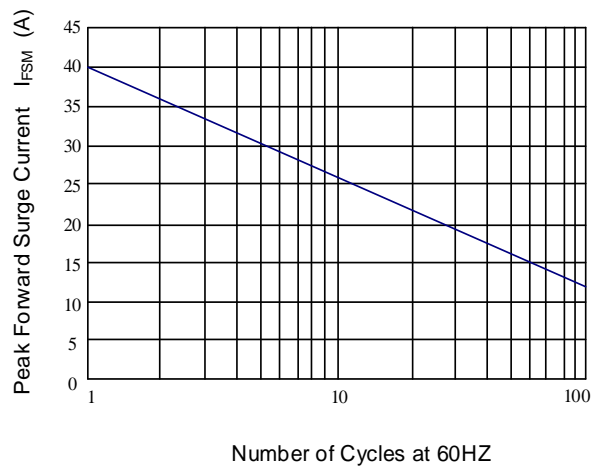
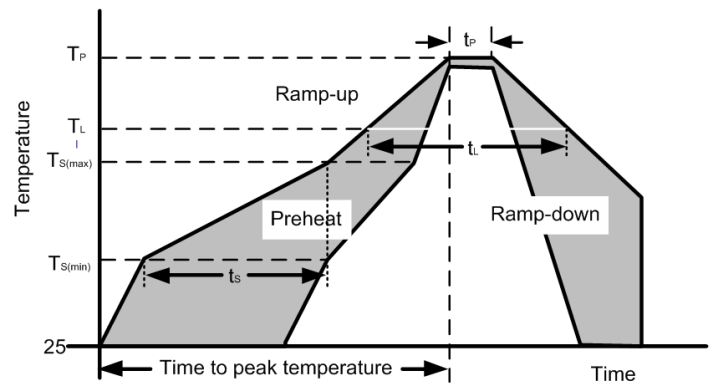

Figure 6: Maximum Non-Repetitive Forward Surge Current Only Unidirectional



Soldering Parameters

Condition		
Pre Heat	Temperature min ( $T_{S(min)}$ )	150°C
	Temperature max ( $T_{S(max)}$ )	200°C
	Time (min to max) ( $t_s$ )	60-190 s
Average ramp up rate (Liquidus Temp) ( $T_L$ ) to peak		3°C/s max
Ts(max) to TL - Ramp-up Rate		3°C/s max
Reflow	Temperature ( $T_L$ ) (Liquidus)	217°C
	Temperature ( $t_L$ )	60-150 s
Peak Temperature ( $T_P$ )		260 <sup>+0/-5</sup> °C
Time within actual peak Temperature ( $t_p$ )		20-40 s
Ramp-down Rate		5°C/s max
Time 25°C to peak Temperature ( $T_P$ )		8 minutes max
Do not exceed		260°C



Outline Drawing - DO-204AL(DO-41)

Ref. (mm)	Millimeters	
	Min.	Max.
A	25.40	-
B	4.10	5.20
C	0.71	0.86
D	2.00	2.70

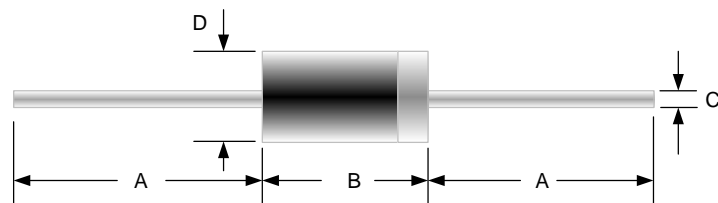

DO-204AL(DO-41)

Part Numbering System

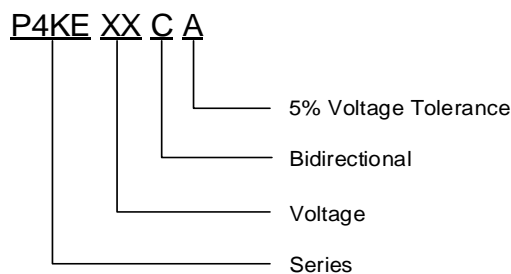

## Part Marking System

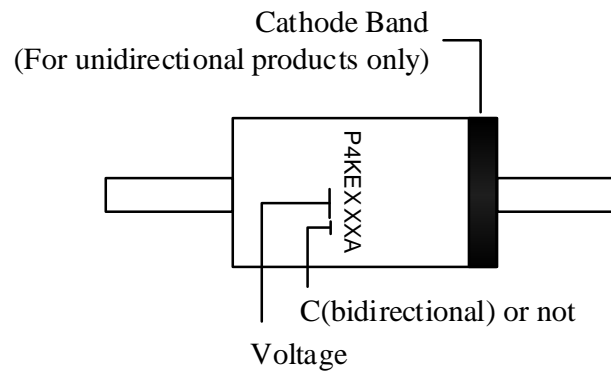

## Package Information

Package Type	Description	Quantity (pcs)
DO-204AL	Tape & Box	3000

## CONTACT INFORMATION

No.1001, Shiwan(7) Road, Pudong District, Shanghai, P.R.China.201207

Tel: +86-21-68969993 Fax: 86-21-50757680 Email: market@way-on.com

WAYON website: <http://www.way-on.com>

For additional information, please contact your local Sales Representative.

**WAYON**® is registered trademarks of Wayon Corporation.

*Specifications are subject to change without notice.  
The device characteristics and parameters in this data sheet can and do vary in different applications and actual device performance may vary over time.  
Users should verify actual device performance in their specific applications.*

单击下面可查看定价，库存，交付和生命周期等信息

[>>WAY-ON\(维安\)](#)