

- **Main Characteristics**  
SMD Fuse; Slow Blow(S);0603  
Designed to UL E311435
- **Materials**  
Body: Ceramic  
Termination: Silver over-plated with nickel and Tin
- **Environment Standard**  
Lead-free, Halogen-free, RoHS
- **Vibration Resistance**  
10-60Hz at 0.75mm amplitude  
60-2000Hz at 10g acceleration
- **Stock Temperature**  
+10°C to +60°C  
Relative humidity: ≤75% yearly average  
Without dew, maximum 30 days at 95%
- **Operating temperature:**  
-55°C to +150°C (with de-rating)

**0603WNS series (Rev:C) SMD chip fuse**

■ **Applications**

Circuit Protecting in notebook PC, telecom system, LCD/PDP TV, wireless goods,LCD monitor, white goods, LCD/PDP panel, game console, power supply, net working and other electronics products.

■ **Product Dimensions and Recommended Land Pattern (mm)**

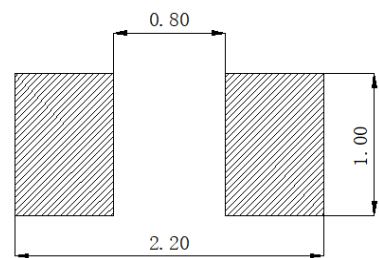
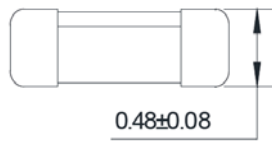
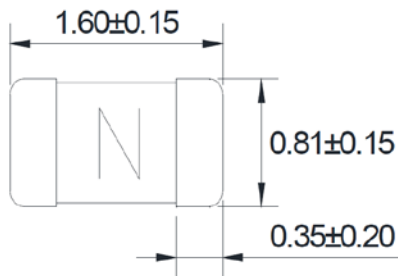

Dimensions

Recommended Land Pattern

■ **Clear-Time Characteristics (Slow Blow)**

% of current rating	Clear-time at 25 °C
	1A-8A
100%	4 hours min.
200%	1-60 seconds.
250%	5 seconds max.

■ **Part Numbering**

**0603 W NS 150A 032V (A)**

(1) (2) (3) (4) (5) (6)

- (1) Size code: Standard EIA Chip Size
- (2) Company code: Wayon Chip Fuse
- (3) Series code: NS series
- (4) Current rating code:150A-1.5A
- (5) Voltage rating code:032V-32VDC
- (6) Supplementary Code: The default is empty,alphabet and number denoting customer code or package code.

## Electrical Characteristics

Part number	Current Rating	Voltage Rating	Interrupting Ratings	Nominal Cold DCR	Nominal $I^2t$	Marking Code
	A	V/DC	A	mΩ	(A <sup>2</sup> s)	
0603WNS100A032V	1	32	50A@32V	249.5	0.012	B
0603WNS150A032V	1.5			149	0.047	H
0603WNS200A032V	2			73.5	0.118	K
0603WNS250A032V	2.5			46.5	0.145	L
0603WNS300A032V	3			34.5	0.25	O
0603WNS350A032V	3.5			26.5	0.55	R
0603WNS400A032V	4			20.5	0.59	S
0603WNS500A032V	5			13	1.25	T
0603WNS600A032V	6			11	1.75	V
0603WNS700A032V	7			9	2.35	X
0603WNS800A032V	8			7	3.1	Z

- Notice: 1. DC interrupting rating (measured at rated voltage, time constant of less than 50 microseconds, battery source)  
 2. DC cold resistance are measured at <10% of rated current in ambient temperature of 25°C  
 3. The current values used for calculating I<sup>2</sup>T should be 10In current.  
 4. For 1A-5A, the color of glass coating is green; for others, it's blue

## Average Clear-Time Curves

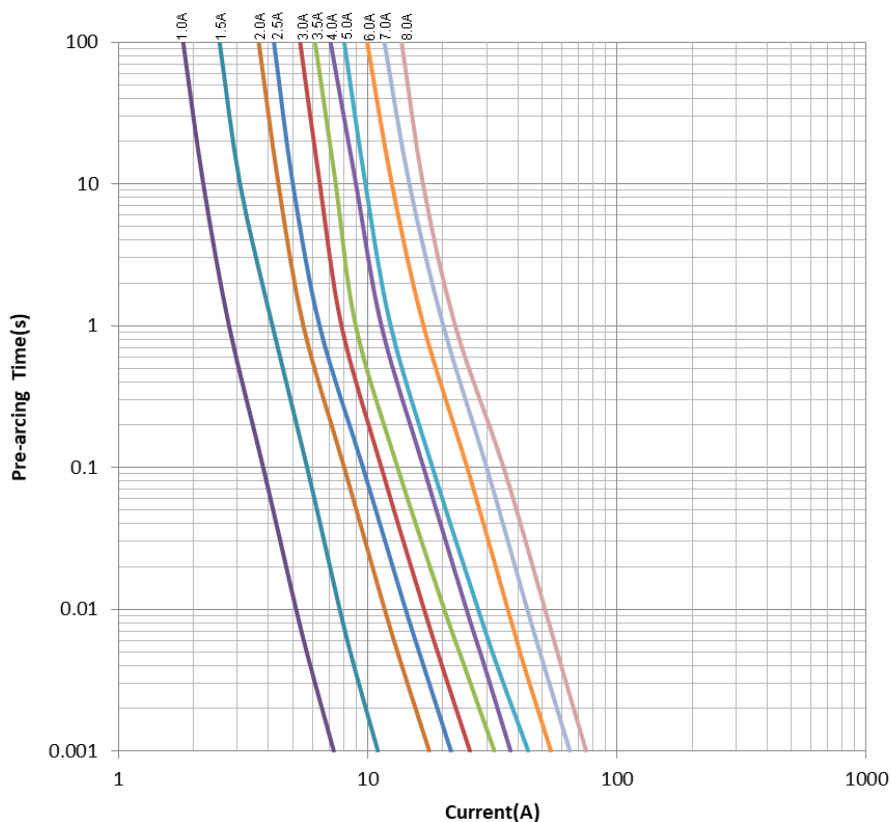

Specifications are subject to change without notice

Wayon Electronics Co.,Ltd.

No. 1001, Shiwan Qi Road, Shanghai 201202, P. R. China

Tel: 86-21- 50968322

E-mail: [hanql@way-on.com](mailto:hanql@way-on.com)

[Http://www.way-on.com](http://www.way-on.com)

## Solder Reflow Recommendations

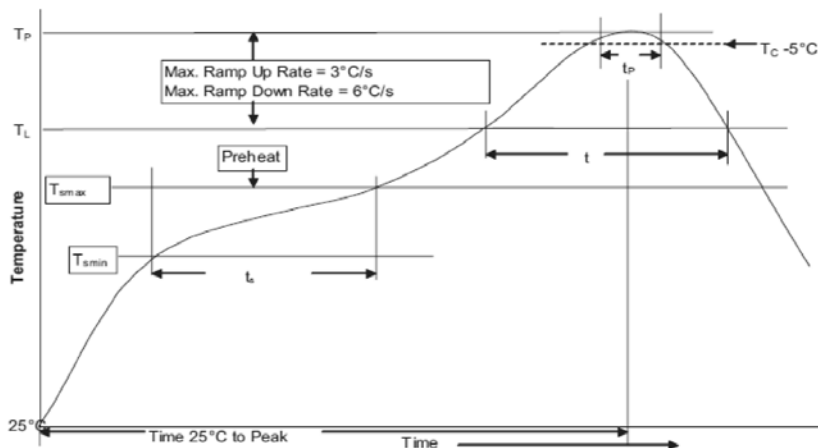

### Recommended conditions for hand soldering:

#### 1. Infrared Reflow:

Temperature: 260 °C

Time: 5sec Max.

Recommend reflow profile

#### 2. Wave Soldering

Reservoir Temperature: 260 °C

Time in Reservoir: 10sec Max.

Profile Feature		Pb-Free Assembly
Average Ramp-UP Rate(T <sub>smax</sub> to T <sub>p</sub> )		3°C/s Max.
Preheat	Temperature Min(T <sub>s min</sub> )	150°C
	Temperature Max(T <sub>s max</sub> )	200°C
	Time(T <sub>smin</sub> to T <sub>s max</sub> )	60sec~ 120sec
Liquidous temperature(T <sub>L</sub> )		217°C
Time at liquidous(t <sub>L</sub> )		60~150S
Peak package body temperature(T <sub>p</sub> )		260°C
Time (t <sub>p</sub> ) within 5°C of the specified classification temperature (T <sub>c</sub> )		30S
Average ramp-down rate (T <sub>p</sub> to T <sub>smax</sub> )		6°C/s Max.
Time (25°C to Peak Temperature)		8 minutes Max.

## Reliability Tests:

No.	Test	Requirement	Test condition	Test reference
1	Resistance to Solder Heat	DCR change $\leq \pm 10\%$ No mechanical damage	One dip at 260 sec	MIL-STD-202 Method 210
2	Solderability	Minimum 95% coverage	One dip at 235 °C 5sec	MIL-STD-202 Method 208
3	Mechanical Shock	DCR change $\leq \pm 10\%$ No mechanical damage	Figure 1 of Method 213. Condition C 100g 6ms	MIL-STD-202 Method 213
4	Humidity Bias	DCR change $\leq \pm 10\%$ No mechanical damage	1000 hours 85°C/85%RH	MIL-STD-202 Method 103
5	Thermal shock	DCR change $\leq \pm 10\%$ No mechanical damage	300 cycles between -55 °C and +125°C	MIL-STD-202 Method 107
6	Moisture resistance	DCR change $\leq \pm 15\%$ No mechanical damage	50 cycles	MIL-STD-202 Method 106
7	High Temperature Exposure	DCR change $\leq \pm 10\%$ No mechanical damage	degree C without power, 1000h	MIL-STD-202 Method 108

Specifications are subject to change without notice

## Electrical Specifications:

### Clear-Time Characteristics:

Same as specified on the Short Form Data Sheet

### Insulation Resistance after Opening:

20,000 ohms minimum when cleared with rated voltage applied. Fuse clearing under low voltage conditions may result in lower after clearing insulation resistance values. (Note: Under normal fault conditions (low or rated voltage conditions), WAYON chip fuses provide sufficient after clearing insulation resistance values for circuit protection.)

### Current Carrying Capacity:

100% rated current at +25°C ambient for 4 hours minimum when evaluated per MIL-PRF-23419

### Interrupt Ratings:

Same as specified on the Short Form Data Sheet

### Fuse Selection and Temperature De-rating Guideline:

The ambient temperature affects the current carrying capacity of fuses. When a fuse is operating at a temperature higher than 25°C, the fuse shall be "de-rated".

To select a fuse from the catalog, the following rule may be followed: Catalog Fuse Current Rating = Nominal Operating Current / 0.75 / % De-rating at the maximum operating temperature.

Example: At 100°C, % De-rating is 80%. The nominal operating current is 4A. The current rating for fuse selected from the catalog shall be:

$$4 / 0.75 / 80\% = 6.67A.$$

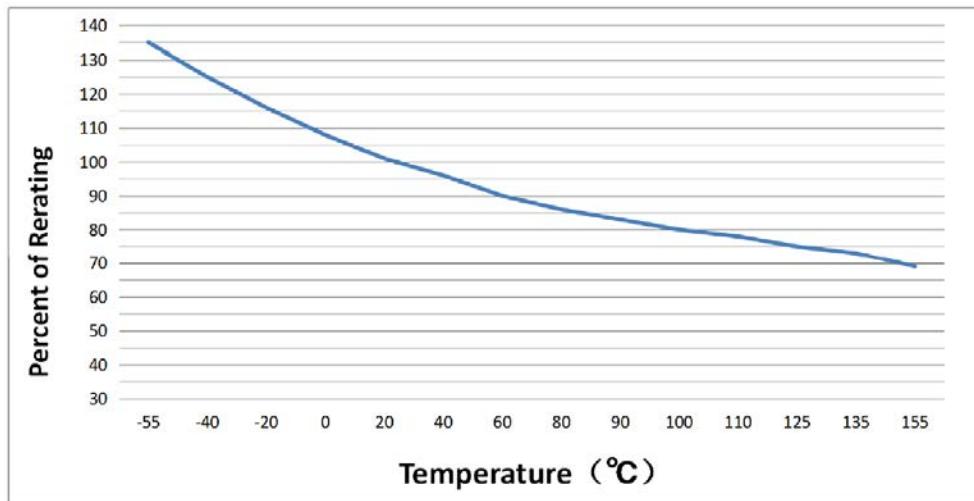

## Packaging and Storage:

### Storage

The maximum ambient temperature shall not exceed 40°C. Storage temperatures higher than 40°C could result in the deformation of packaging materials. The maximum relative humidity recommended for storage is 70%. High humidity with high temperature can accelerate the oxidation of the solder plating on the termination and reduce the solderability of the components. Sealed plastic bags with desiccant shall be used to reduce the oxidation of the termination and shall only be opened prior to use. The products shall not be stored in areas where harmful gases containing sulfur or chlorine are present.

### Packaging

WAYON's chip fuse are provided on tape-and-reel for use in pick-and-place machines or in bulk for special applications. Both tape-and-reel and bulk products are sealed in plastic bags with desiccant.

### Packaging Data

Quantity per reel 5,000pcs

*Specifications are subject to change without notice*

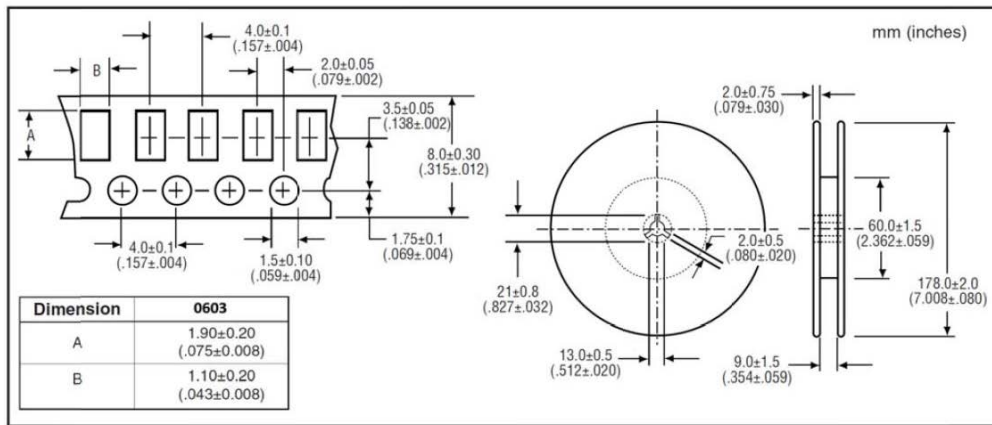

## ■ Cautions and warnings:

### 1、 Handling

- CHIP FUSE must not be dropped. Chip-offs must not be caused during handling of FUSES.
- Components must not be touched with bare hands. Gloves are recommended.
- Avoid contamination of fuse surface during handling.

### 2、 Soldering

- Use resin-type flux or non-activated flux.
- Insufficient preheating may cause ceramic cracks.
- Rapid cooling by dipping in solvent is not recommended.
- Complete removal of flux is recommended.

### 3、 Mounting

- Electrode must not be scratched before/during/after the mounting process.
- Contacts and housings used for assembly with fuses have to be clean before mounting.
- During operation, the fuse's surface temperature can be very high (ICL). Ensure that adjacent components are placed at a sufficient distance from the fuse to allow for proper cooling of the fuses.
- Ensure that adjacent materials are designed for operation at temperatures comparable to the surface temperature of the fuse. Be sure that surrounding parts and materials can withstand this temperature.
- Avoid contamination of fuse surface during processing.

### 4、 Operation

- Use fuses only within the specified operating temperature range.
- Environmental conditions must not harm the fuses. Use fuses only in normal atmospheric conditions.
- Contact of chip fuses with any liquids and solvents should be prevented. It must be ensured that no water enters the chip fuse (e.g. through plug terminals). For measurement purposes (checking the specified resistance vs. temperature), the component must not be immersed in water but in suitable liquids (e.g. Galden).
- Avoid dewing and condensation.

## ■ Notice:

Specifications of the products displayed herein are subject to change without notice. We assume no responsibility or liability for any errors or inaccuracies.

Information contained herein is intended to provide a product description only. No license, express or implied, by estoppel or otherwise, to any intellectual property rights is granted by this document. Except as provided in Wayon's terms and conditions of sale for such products, Wayon assumes no liability whatsoever, and disclaims any express or implied warranty, relating to sale and/or use of Wayon products including liability or warranties relating to fitness for a particular purpose, merchantability, or infringement of any patent, copyright, or other intellectual property right.

*Specifications are subject to change without notice*

单击下面可查看定价，库存，交付和生命周期等信息

[>>WAY-ON\(维安\)](#)