



WSxxP30SMC(-B)-AT

Automotive Load Dump Protection TVS

Features

- 3000 watts Peak Pulse Power (10/1000 μ s)
- Unidirectional and Bidirectional Protection
- Fast Response Time : Typically < 1ns
- Excellent Clamping Capability
- Built-in Strain relief
- Low inductance
- Low profile package
- High temperature solder:260°C/10 seconds at terminal
- AEC-Q101 compliant

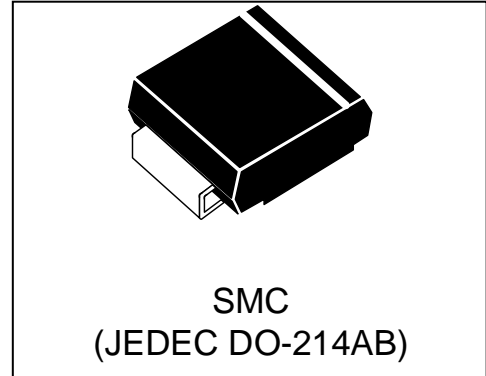

Mechanical Characteristics

- JEDEC DO-214AB package
- Molding compound flammability rating:
UL 94V-0
- Marking : Marking Code
- Packaging : Tape and Reel per EIA 481
- RoHS Compliant

Applications

- Auto power system
- Car audio and video
- Automotive instrument
- Car GPS
- Can-bus

Absolute Maximum Rating

| Rating | Symbol | Value | Units |
|--|------------------|--------------------------------|-------|
| Peak Pulse Power (tp =10/1000 μ s) (see Note1&2) | P _{PPM} | 3000 | Watts |
| Peak pulse current (10/1000 μ s) (see Note2) | I _{PPM} | See Electrical Characteristics | A |
| Power Dissipation on infinite heat sink T _L = 50 °C (Fig 4) | P _D | 6.5 | W |
| Operating Junction Temperature range | T _J | -65 to + 150 | °C |
| Storage Temperature range | T _{STG} | -65 to + 150 | °C |

Note1: Peak Pulse Power Rating as Pulse Width ,per Fig1.

Note2: Peak Pulse Power or Current Derated above T_A=25°C Per Fig. 2 and Non-Repetitive Current Pulse, Per Fig.3.

Electrical Characteristics

| Part Number | | Marking | | Reverse Stand off Voltage V_{RWM} (Volts) | Breakdown Voltage $V_{BR}@I_T$ (Volts) | | Test Current I_T (mA) | Maximum Clamping Voltage $V_c@I_{FP}$ (Volts) | Maximum Peak Pulse Current I_{PP} (Amps) | Maximum Reverse Leakage $I_R@V_{RWM}$ (μ A) |
|---------------|-----------------|-----------|----------|---|--|-------|-------------------------|---|--|--|
| UNI-POLAR | BI-POLAR | UNI-POLAR | BI-POLAR | | MIN | MAX | | | | |
| WS15P30SMC-AT | WS15P30SMC-B-AT | DYLP | DZLP | 15 | 16.70 | 18.50 | 1 | 24.4 | 123.0 | 2 |
| WS16P30SMC-AT | WS16P30SMC-B-AT | DYLQ | DZLQ | 16 | 17.80 | 19.70 | 1 | 26.0 | 115.4 | 2 |
| WS18P30SMC-AT | WS18P30SMC-B-AT | DYLS | DZLS | 18 | 20.00 | 22.10 | 1 | 29.2 | 102.7 | 2 |
| WS20P30SMC-AT | WS20P30SMC-B-AT | DYMY | DZMZ | 20 | 22.20 | 24.50 | 1 | 32.4 | 92.6 | 2 |
| WS22P30SMC-AT | WS22P30SMC-B-AT | DYMM | DZMM | 22 | 24.40 | 26.90 | 1 | 35.5 | 84.5 | 2 |
| WS24P30SMC-AT | WS24P30SMC-B-AT | DYMO | DZMO | 24 | 26.70 | 29.50 | 1 | 38.9 | 77.1 | 2 |
| WS26P30SMC-AT | WS26P30SMC-B-AT | DYMQ | DZMQ | 26 | 28.90 | 31.90 | 1 | 42.1 | 71.3 | 2 |
| WS28P30SMC-AT | WS28P30SMC-B-AT | DYMS | DZMS | 28 | 31.10 | 34.40 | 1 | 45.4 | 66.1 | 2 |
| WS30P30SMC-AT | WS30P30SMC-B-AT | DYNY | DZNY | 30 | 33.30 | 36.80 | 1 | 48.4 | 62.0 | 2 |
| WS33P30SMC-AT | WS33P30SMC-B-AT | DYNN | DZNN | 33 | 36.70 | 40.60 | 1 | 53.3 | 56.3 | 2 |
| WS36P30SMC-AT | WS36P30SMC-B-AT | DYNQ | DZNQ | 36 | 40.00 | 44.20 | 1 | 58.1 | 51.6 | 2 |
| WS40P30SMC-AT | WS40P30SMC-B-AT | DYOY | DZOY | 40 | 44.40 | 49.10 | 1 | 64.5 | 46.5 | 2 |
| WS43P30SMC-AT | WS43P30SMC-B-AT | DYON | DZON | 43 | 47.80 | 52.80 | 1 | 69.4 | 43.2 | 2 |

Typical Characteristics

Figure 1. Peak Pulse Power Rating Curve

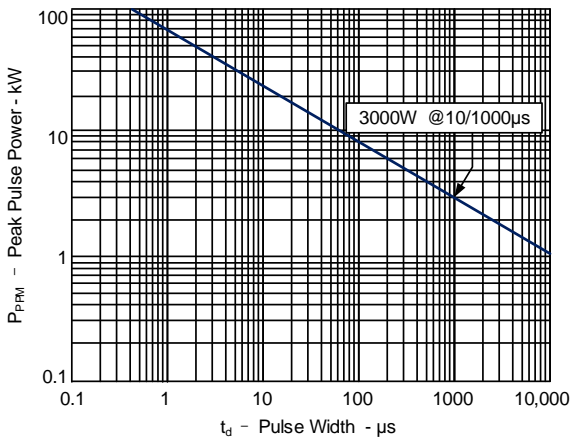

Figure 2. Pulse Derating Curve

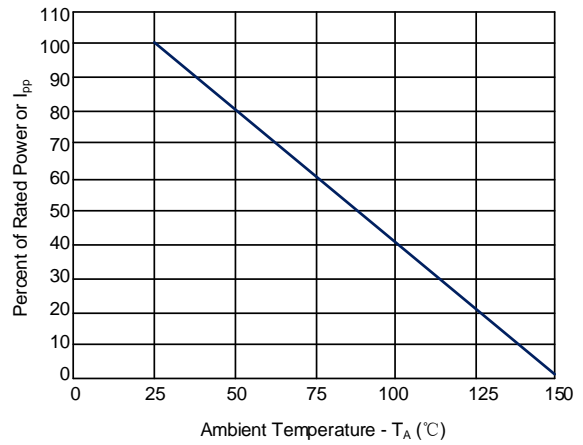

Figure 3. Pulse Waveform

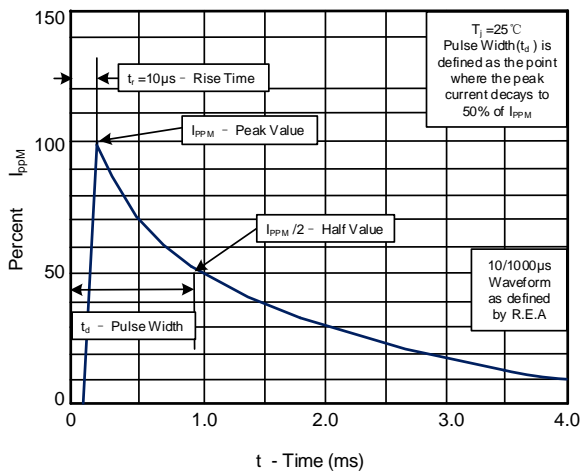
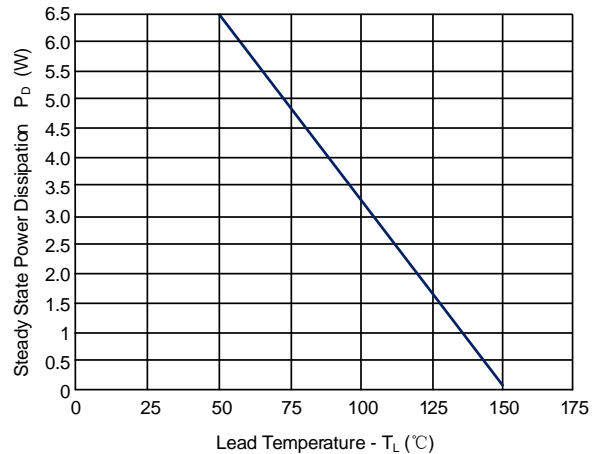
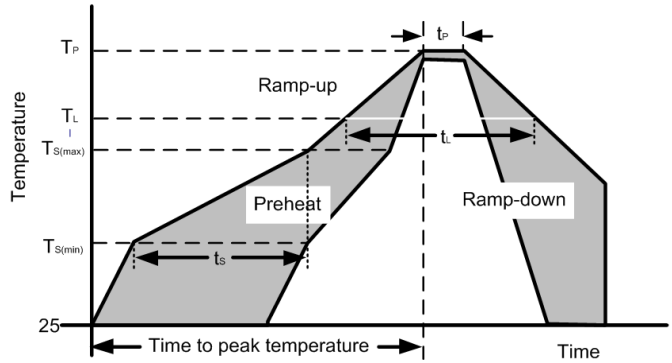

Figure 4. Steady State Power Dissipation Derating Curve



Soldering Parameters

| Reflow Condition | | |
|--|----------------------------------|-------------------------|
| Pre Heat | Temperature Min ($T_{s(min)}$) | 150°C |
| | Temperature Max ($T_{s(max)}$) | 200°C |
| | Time (min to max) (t_s) | 60-190 s |
| Average ramp up rate (Liquidus Temp) (T_L) to peak | | 3°C/s max |
| Ts(max) to TL - Ramp-up Rate | | 3°C/s max |
| Reflow | Temperature(T_L) (Liquidus) | 217°C |
| | Temperature (t_L) | 60-150 s |
| Peak Temperature (T_P) | | 260 ^{+0/-5} °C |
| Time within actual peak Temperature (t_p) | | 20-40 s |
| Ramp-down Rate | | 6°C/s max |
| Time 25°C to peak Temperature (T_P) | | 8 minutes max |
| Do not exceed | | 260°C |



Outline Drawing – SMC (DO-214AB)

| Ref. (mm) | Millimeters | |
|-----------|-------------|------|
| | Min. | Max. |
| A | 2.06 | 2.70 |
| A1 | - | 0.30 |
| B | 2.90 | 3.20 |
| E | 6.60 | 7.40 |
| E1 | 7.75 | 8.13 |
| D | 5.59 | 6.22 |
| L | 0.76 | 1.52 |

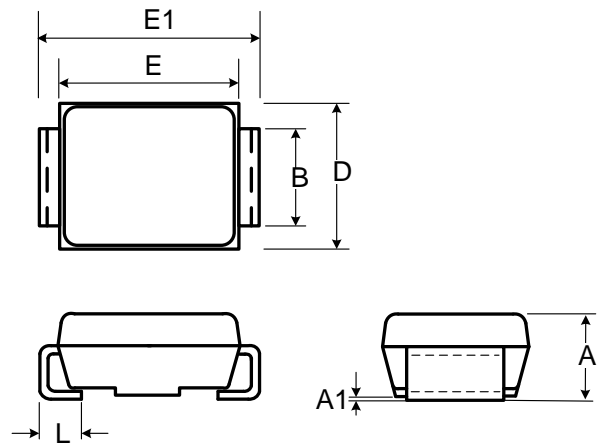

Recommended Solder Pad Layout

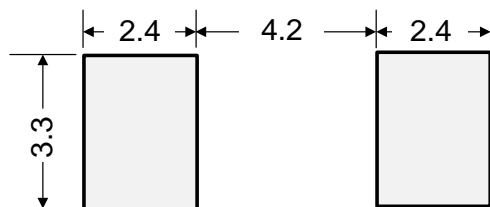

Dimensions in mm

Part Numbering System

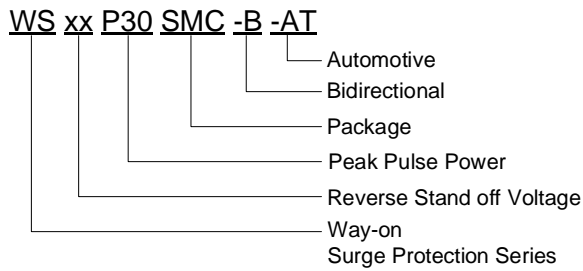

Part Marking System

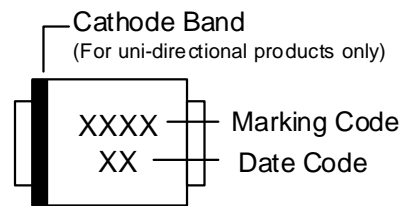

Package Information

| Package Type | Description | Quantity (pcs) |
|---------------|----------------------------|----------------|
| SMC(DO-214AB) | Tape & Reel -16mm/13" tape | 3000 |

Contact Information

No.1001, Shiwan(7) Road, Pudong District, Shanghai, P.R.China.201207

Tel: +86-21-68969993 Fax: 86-21-50757680 Email: market@way-on.com

WAYON website: <http://www.way-on.com>

For additional information, please contact your local Sales Representative.

WAYON® is registered trademarks of Wayon Corporation.

Specifications are subject to change without notice.

The device characteristics and parameters in this data sheet can and do vary in different applications and actual device performance may vary over time.

Users should verify actual device performance in their specific applications.

单击下面可查看定价，库存，交付和生命周期等信息

[>>WAY-ON\(维安\)](#)