

Transient Voltage Suppressor

Features

- Solid-state silicon-avalanche technology
- Low operating and clamping voltage
- Up to two I/O Lines of Protection
- Ultra low capacitance
- Low operating voltage:3.3V
- Low Leakage Current

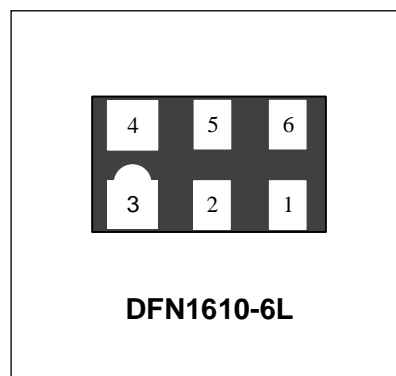

IEC COMPATIBILITY (EN61000-4)

- IEC 61000-4-2 (ESD) $\pm 30\text{kV}$ (air), $\pm 30\text{kV}$ (contact)
- IEC 61000-4-4 (EFT) 40A (5/50ns)
- IEC 61000-4-5 (Lightning) 8A (8/20 μs)

Mechanical Characteristics

- DFN1610-6L package
- Marking : Marking Code
- Packaging : Tape and Reel per EIA 481
- RoHS Compliant

Applications

- Digital Visual Interface(DVI)
- MDDI Ports
- Display Port TM Interface
- PCI Express
- High Definition Multi-Media Interface(HDMI)
- HDMI Interfaces

Schematic & PIN Configuration

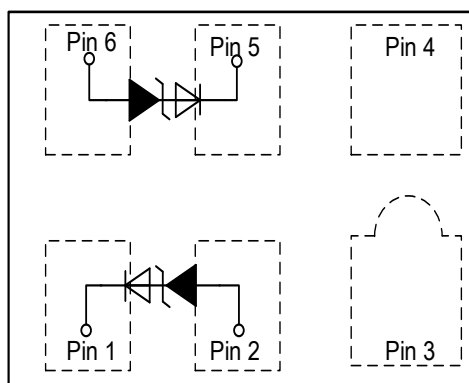

DFN1610-6L (Top View)

Absolute Maximum Rating

Rating	Symbol	Value	Units
Peak Pulse Power ($t_p = 8/20\mu s$)	P_{PP}	128	Watts
Peak Pulse Current ($t_p = 8/20\mu s$)	I_{PP}	8	A
Operating Temperature	T_J	-55 to + 125	°C
Storage Temperature	T_{STG}	-55 to +150	°C

Electrical Parameters

Symbol	Parameter
I_{PP}	Reverse Peak Pulse Current
V_C	Clamping Voltage @ I_{PP}
V_{RWM}	Reverse Stand-Off Voltage
I_R	Reverse Leakage Current @ V_{RWM}
V_{BR}	Breakdown Voltage @ I_T
I_T	Test Current

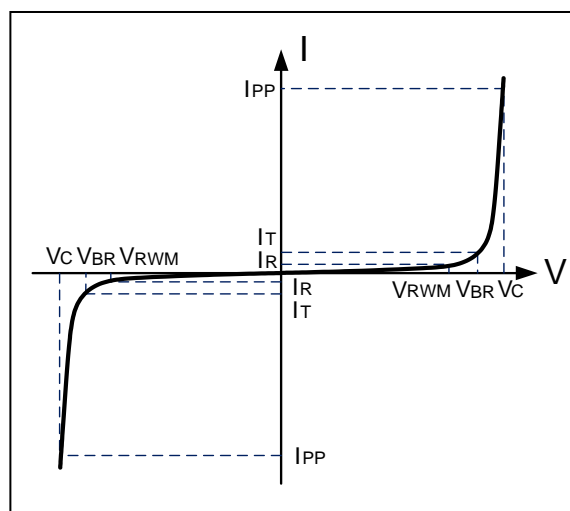

Electrical Characteristics (T=25°C unless otherwise noted)

WS03-2RUCB						
Parameter	Symbol	Conditions	Minimum	Typical	Maximum	Units
Reverse Stand-Off Voltage	V_{RWM}				3.3	V
Reverse Breakdown Voltage	V_{BR}	$I_T = 1mA$	4			V
Reverse Leakage Current	I_R	$V_{RWM} = 3.3V$			200	nA
Clamping Voltage	V_C	$I_{PP} = 8A, t_p = 8/20\mu s$ See Note3		14	16	V
Dynamic Resistance ^{1,2}	R_{DYN}	TLP=0.2/100ns		0.47		Ω
ESD Clamping Voltage ¹	V_C	$I_{PP} = 4A$ $t_p = 0.2/100ns$		8.2		V
ESD Clamping Voltage ¹	V_C	$I_{PP} = 16A$ $t_p = 0.2/100ns$		13.7		V
Junction Capacitance	C_j	$V_R = 0V, f = 1MHz$ Pin1&Pin6 to Pin2&Pin5		0.35	0.6	pF

- Note:**
- 1、 TLP Setting : $t_p = 100ns, t_r = 0.2ns, I_{TLP}$ and V_{TLP} sample window: $t_1 = 70ns$ to $t_2 = 90ns$.
 - 2、 Dynamic resistance calculated from $I_{PP} = 4A$ to $I_{PP} = 16A$ using "Best Fit"
 - 3、 Device measured from Pin1&Pin6 to Pin2&Pin5.

Typical Characteristics

Figure 1: Peak Pulse Power vs. Pulse Time

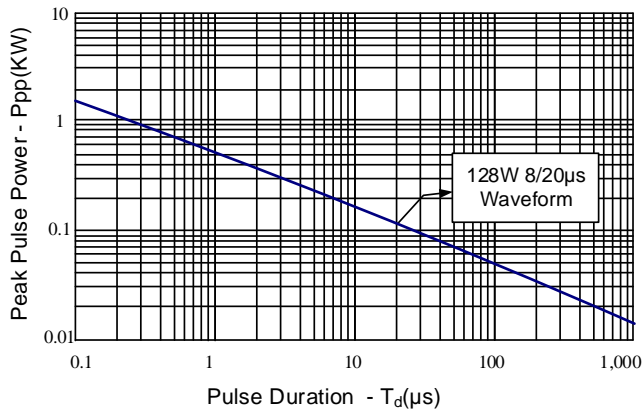

Figure 2: Power Derating Curve

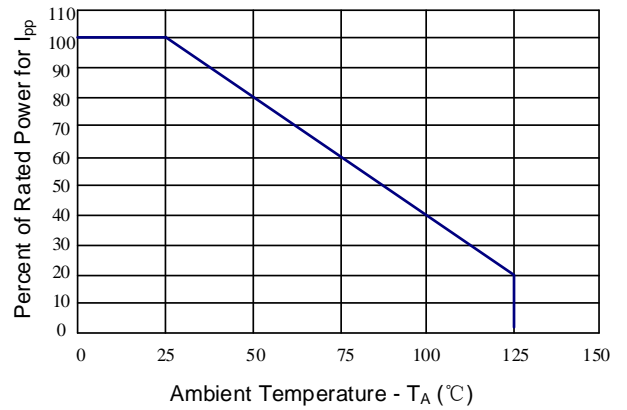

Figure 3: Clamping Voltage vs. Peak Pulse Current

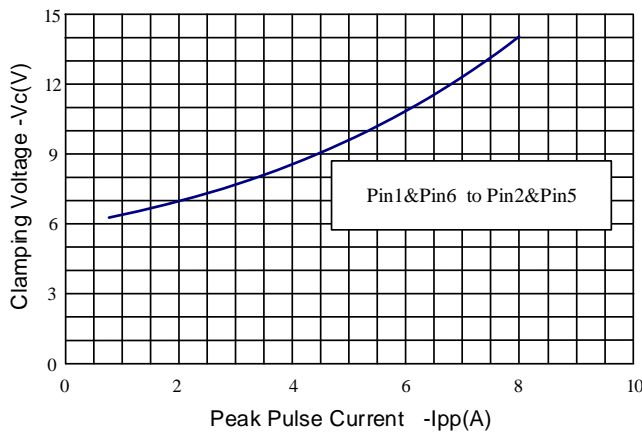

Figure 4: Normalized Junction Capacitance vs. Reverse Voltage

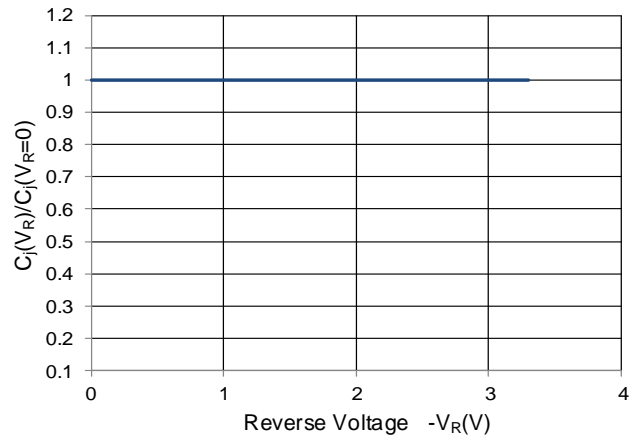

Figure 5: TLP I-V Curve(Pin1&Pin6 to Pin2&Pin5)

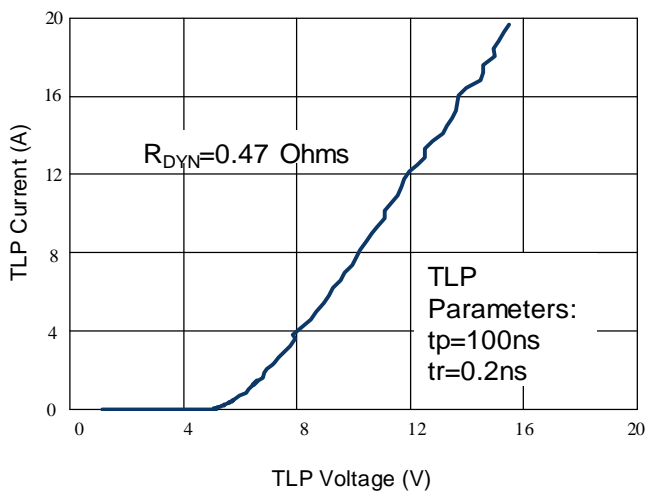
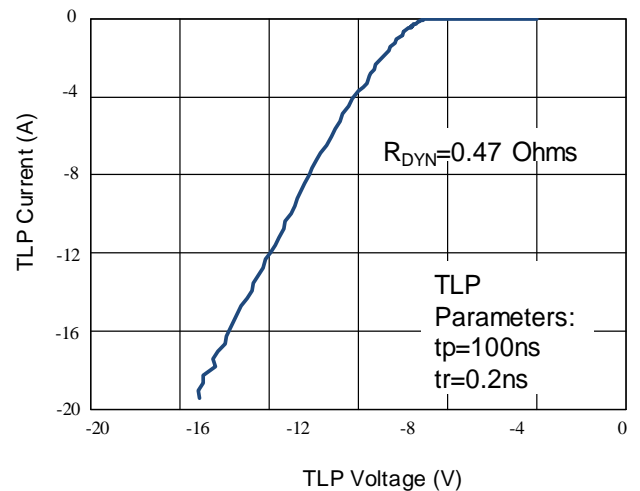
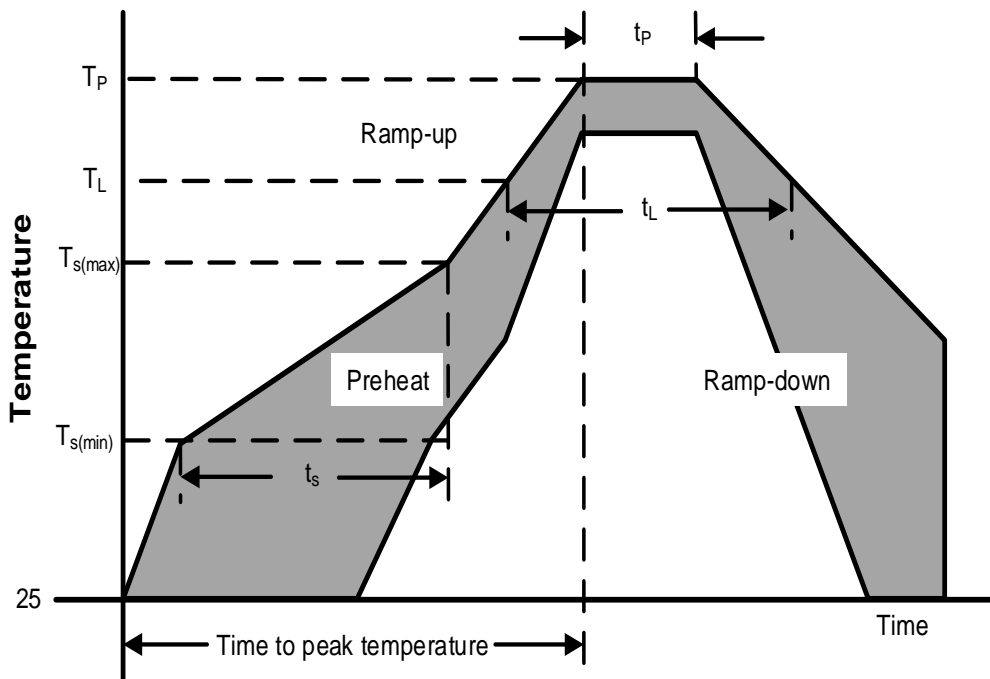

Figure 6: TLP I-V Curve(Pin2&Pin5 to Pin1&Pin6)



Soldering Parameters

Reflow Condition		Pb – Free assembly
Pre Heat	Temperature Min ($T_{s(min)}$)	150°C
	Temperature Max ($T_{s(max)}$)	200°C
	Time (min to max) (t_s)	60 – 190 secs
Average ramp up rate (Liquidus Temp) (T_L) to peak		5°C/second max
$T_{s(max)}$ to T_L —Ramp-up Rate		5°C/second max
Reflow	Temperature (T_L) (Liquidus)	217°C
	Temperature (t_L)	60 – 150 seconds
Peak Temperature (T_P)		260+0/-5 °C
Time within actual peak Temperature (t_p)		20 – 40 seconds
Ramp-down Rate		5°C/second max
Time 25°C to peak Temperature (T_P)		8 minutes Max.
Do not exceed		280°C



Outline Drawing – DFN1610-6L

TOP VIEW

BOTTOM VIEW

SIDE VIEW

SYMBOL	MILLIMETERS		
	MIN	NOM	MAX
A	-	0.450	0.550
A1	-	-	0.005
A2	-	0.050	0.150
D	1.600	1.550	1.650
E	1.000	0.950	1.050
b	0.200	0.150	0.250
b1	0.400	0.350	0.450
L	0.330	0.280	0.380
L1	0.050	0.010	0.090
R	0.125REF		
e	0.500BSC		
e1	0.500BSC		

DIMENSIONS		
DIM	INCHES	MILLIMETERS
C	0.024	0.60
G	0.004	0.10
P	0.020	0.50
P1	0.039	1.00
X	0.012	0.30
Y	0.020	0.50
Y1	0.043	1.10

Notes:
Controlling Dimension: Millimeter.

Marking Codes

Part Number	Marking Code
WS03-2RUCB	<div style="border: 1px solid black; padding: 5px; display: inline-block;"> E2CB • </div>

Package Information

Qty: 3k/Reel

CONTACT INFORMATION

No.1001, Shiwan (7) Road, Pudong District, Shanghai, P.R.China.201207
 Tel: 86-21-68969993 Fax: 86-21-50757680 Email: market@way-on.com
 WAYON website: <http://www.way-on.com>

For additional information, please contact your local Sales Representative.

WAYON ® is registered trademark of Wayon Corporation.

Specifications are subject to change without notice.
 The device characteristics and parameters in this data sheet can and do vary in different applications and actual device performance may vary over time.
 Users should verify actual device performance in their specific applications.

单击下面可查看定价，库存，交付和生命周期等信息

[>>WAY-ON\(维安\)](#)