



# WSxxP30SMC(-B)

## Power Transient Voltage Suppressor

### Features

- 3000 watts Peak Pulse Power (10/1000µs)
- Unidirectional and Bidirectional Protection
- Fast Response Time : Typically < 1ns
- Excellent Clamping Capability
- Built-in Strain relief
- Low inductance
- Low profile package
- High temperature solder:260°C/10 seconds at terminal

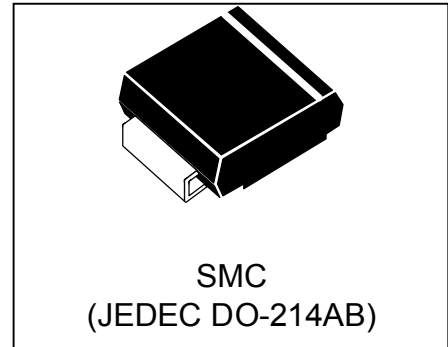

### Mechanical Characteristics

- JEDEC DO-214AB package
- Molding compound flammability rating: UL 94V-0
- Marking: Marking Code
- Packaging: Tape and Reel per EIA 481
- RoHS &UL497B Compliant

### Applications

- I/O Interfaces
- Power lines
- Automotive and Telecommunication
- Signal lines of sensor units for consumer
- Industrial Electronics
- Computer

Absolute Maximum Rating			
Rating	Symbol	Value	Units
Peak Pulse Power (tp =10/1000µs) (see Note1,2& 3)	P <sub>PPM</sub>	3000	Watts
Peak pulse current (10/1000µs) (see Note2&3)	I <sub>PPM</sub>	See Electrical Characteristics	A
Peak forward surge current (see Note4&5)	I <sub>FSM</sub>	300	A
Power dissipation on infinite heat sink T <sub>L</sub> = 50 °C (Fig5)	P <sub>D</sub>	6.5	W
Operating junction temperature range	T <sub>J</sub>	-65 to + 150	°C
Storage temperature range	T <sub>STG</sub>	-65 to + 150	°C

**Note1:** Peak Pulse Power Rating as Pulse Width ,per Fig1.

**Note2:** Peak Pulse Power or Current Derated above T<sub>A</sub>=25°C Per Fig. 2 and Non-Repetitive Current Pulse, Per Fig.3.

**Note3:** Mounted on 5.0x5.0mm<sup>2</sup> copper pad to each terminal.

**Note4:** 8.3ms Single Half Sine Wave or Equivalent Square Wave.

**Note5:** Maximum Forward Surge Current only for Unidirectional Device per Fig6.

## Electrical Characteristics

Part Number		Reverse Stand off Voltage $V_{RWM}$ (V)	Breakdown Voltage $V_{BR}(V)@I_T$		Test Current $I_T$ (mA)	Maximum Clamping Voltage $V_C@I_{PP}$ (V)	Maximum Peak Pulse Current $I_{PP}$ (A)	Maximum Reverse Leakage $I_R@V_{RWM}$ ( $\mu$ A)
UNI-POLAR	BI-POLAR		MIN	MAX				
WS5.0P30SMC	WS5.0P30SMC-B	5.0	6.40	7.00	10	9.2	326.1	800
WS6.0P30SMC	WS6.0P30SMC-B	6.0	6.67	7.37	10	10.3	291.3	800
WS6.5P30SMC	WS6.5P30SMC-B	6.5	7.22	7.98	10	11.2	267.9	500
WS7.0P30SMC	WS7.0P30SMC-B	7.0	7.78	8.60	10	12.0	250.0	200
WS7.5P30SMC	WS7.5P30SMC-B	7.5	8.33	9.21	1	12.9	232.6	100
WS8.0P30SMC	WS8.0P30SMC-B	8.0	8.89	9.83	1	13.6	220.6	50
WS8.5P30SMC	WS8.5P30SMC-B	8.5	9.44	10.40	1	14.4	208.3	20
WS9.0P30SMC	WS9.0P30SMC-B	9.0	10.00	11.10	1	15.4	194.8	10
WS10P30SMC	WS10P30SMC-B	10.0	11.10	12.30	1	17.0	176.5	5
WS11P30SMC	WS11P30SMC-B	11.0	12.20	13.50	1	18.2	164.8	2
WS12P30SMC	WS12P30SMC-B	12.0	13.30	14.70	1	19.9	150.8	2
WS13P30SMC	WS13P30SMC-B	13.0	14.40	15.90	1	21.5	139.5	2
WS14P30SMC	WS14P30SMC-B	14.0	15.60	17.20	1	23.2	129.3	2
WS15P30SMC	WS15P30SMC-B	15.0	16.70	18.50	1	24.4	123.0	2
WS16P30SMC	WS16P30SMC-B	16.0	17.80	19.70	1	26.0	115.4	2
WS17P30SMC	WS17P30SMC-B	17.0	18.90	20.90	1	27.6	108.7	2
WS18P30SMC	WS18P30SMC-B	18.0	20.00	22.10	1	29.2	102.7	2
WS20P30SMC	WS20P30SMC-B	20.0	22.20	24.50	1	32.4	92.6	2
WS22P30SMC	WS22P30SMC-B	22.0	24.40	26.90	1	35.5	84.5	2
WS24P30SMC	WS24P30SMC-B	24.0	26.70	29.50	1	38.9	77.1	2
WS26P30SMC	WS26P30SMC-B	26.0	28.90	31.90	1	42.1	71.3	2
WS28P30SMC	WS28P30SMC-B	28.0	31.10	34.40	1	45.4	66.1	2
WS30P30SMC	WS30P30SMC-B	30.0	33.30	36.80	1	48.4	62.0	2
WS33P30SMC	WS33P30SMC-B	33.0	36.70	40.60	1	53.3	56.3	2
WS36P30SMC	WS36P30SMC-B	36.0	40.00	44.20	1	58.1	51.6	2
WS40P30SMC	WS40P30SMC-B	40.0	44.40	49.10	1	64.5	46.5	2
WS43P30SMC	WS43P30SMC-B	43.0	47.80	52.80	1	69.4	43.2	2

## Electrical Characteristics (Cont.)

Part Number		Reverse Stand off Voltage $V_{RWM}$ (V)	Breakdown Voltage $V_{BR}(V)@I_T$		Test Current $I_T$ (mA)	Maximum Clamping Voltage $V_C@I_{PP}$ (V)	Maximum Peak Pulse Current $I_{PP}$ (A)	Maximum Reverse Leakage $I_R@V_{RWM}$ ( $\mu$ A)
UNI-POLAR	BI-POLAR		MIN	MAX				
WS45P30SMC	WS45P30SMC-B	45.0	50.00	55.30	1	72.7	41.3	2
WS48P30SMC	WS48P30SMC-B	48.0	53.30	58.90	1	77.4	38.8	2
WS51P30SMC	WS51P30SMC-B	51.0	56.70	62.70	1	82.4	36.4	2
WS54P30SMC	WS54P30SMC-B	54.0	60.00	66.30	1	87.1	34.4	2
WS58P30SMC	WS58P30SMC-B	58.0	64.40	71.20	1	93.6	32.1	2
WS60P30SMC	WS60P30SMC-B	60.0	66.70	73.70	1	96.8	31.0	2
WS64P30SMC	WS64P30SMC-B	64.0	71.10	78.60	1	103.0	29.1	2
WS70P30SMC	WS70P30SMC-B	70.0	77.80	86.00	1	113.0	26.5	2
WS75P30SMC	WS75P30SMC-B	75.0	83.30	92.10	1	121.0	24.8	2
WS78P30SMC	WS78P30SMC-B	78.0	86.70	95.80	1	126.0	23.8	2
WS85P30SMC	WS85P30SMC-B	85.0	94.40	104.00	1	137.0	21.9	2
WS90P30SMC	WS90P30SMC-B	90.0	100.00	111.00	1	146.0	20.5	2
WS100P30SMC	WS100P30SMC-B	100.0	111.00	123.00	1	162.0	18.5	2
WS110P30SMC	WS110P30SMC-B	110.0	122.00	135.00	1	177.0	16.9	2
WS120P30SMC	WS120P30SMC-B	120.0	133.00	147.00	1	193.0	15.5	2
WS130P30SMC	WS130P30SMC-B	130.0	144.00	159.00	1	209.0	14.4	2
WS150P30SMC	WS150P30SMC-B	150.0	167.00	185.00	1	243.0	12.3	2
WS160P30SMC	WS160P30SMC-B	160.0	178.00	197.00	1	259.0	11.6	2
WS170P30SMC	WS170P30SMC-B	170.0	189.00	209.00	1	275.0	10.9	2

Typical Characteristics

Figure 1. Peak Pulse Power Rating Curve

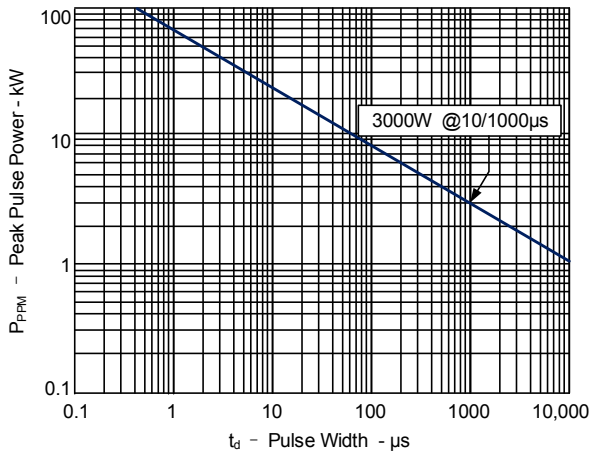

Figure 2. Pulse Derating Curve

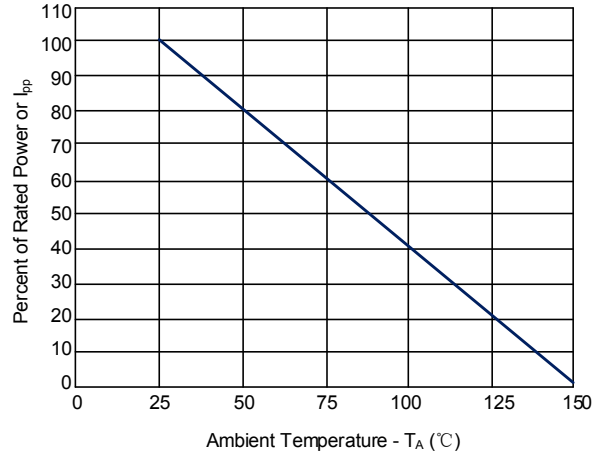

Figure 3. Pulse Waveform

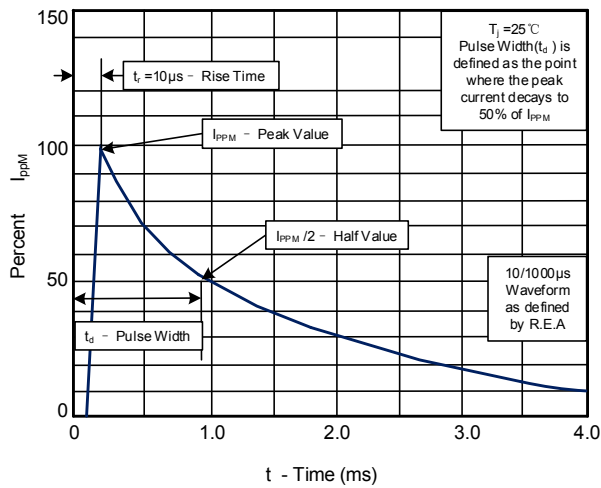

Figure 4. Typical Junction Capacitance

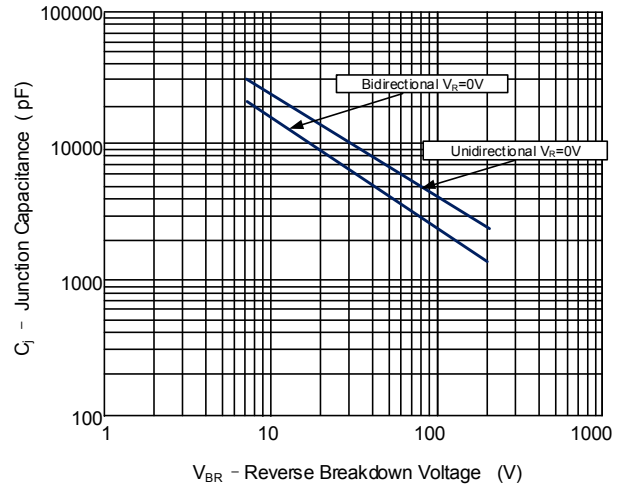

Figure 5. Steady State Power Dissipation Derating Curve

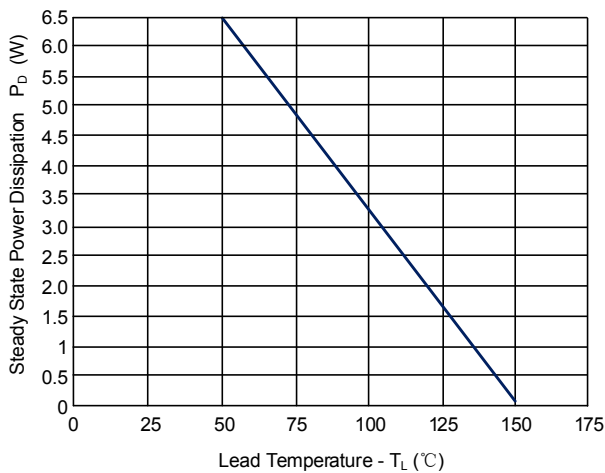
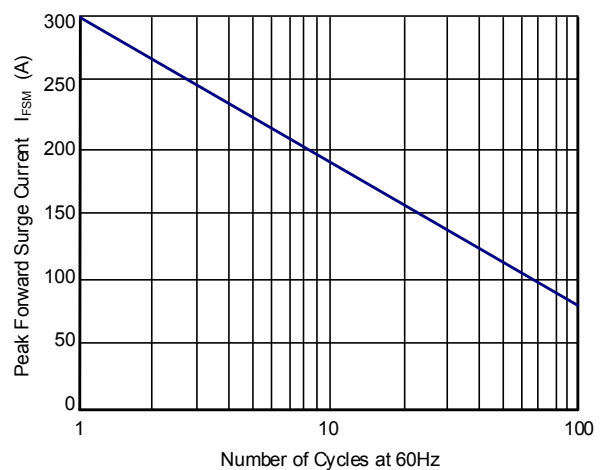
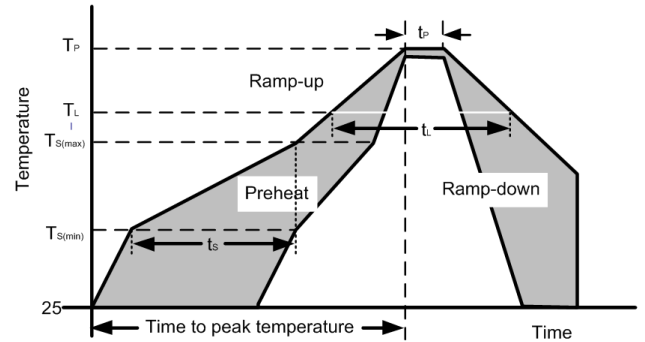

Figure 6. Maximum Non-Repetitive Forward Surge Current Only Unidirectional



Recommended Soldering Parameters

Reflow Condition		
Pre-Heat	Temperature min ( $T_{s(min)}$ )	150°C
	Temperature max ( $T_{s(max)}$ )	200°C
	Time (min to max) ( $t_s$ )	60-190 s
Average ramp up rate (Liquidus Temp) ( $T_L$ ) to peak		3°C/s max
Ts(max) to TL - Ramp-up Rate		3°C/s max
Reflow	Temperature ( $T_L$ ) (Liquidus)	217°C
	Temperature ( $t_L$ )	60-150 s
Peak Temperature ( $T_P$ )		260 <sup>+0/-5</sup> °C
Time within actual peak Temperature ( $t_p$ )		20-40 s
Ramp-down Rate		5°C/s max
Time 25°C to peak Temperature ( $T_P$ )		8 minutes max
Do not exceed		260°C



Outline Drawing – SMC (DO-214AB)

Ref. (mm)	Millimeters	
	Min.	Max.
A	2.06	2.70
A1	-	0.30
B	2.90	3.20
E	6.60	7.40
E1	7.75	8.13
D	5.59	6.22
L	0.76	1.52

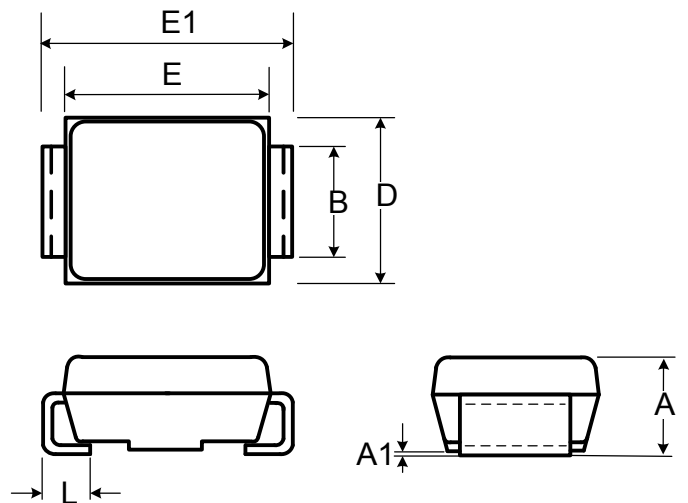

Recommended Solder Pad Layout

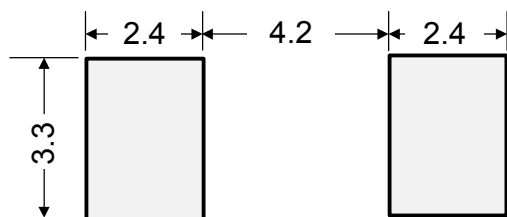

Dimensions in mm

Part Numbering System

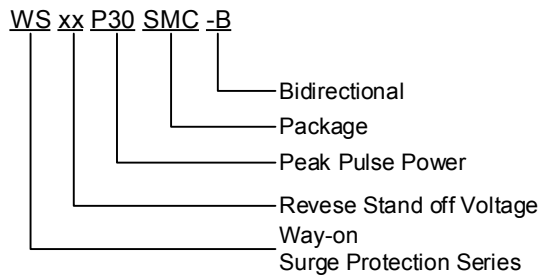

Part Marking System

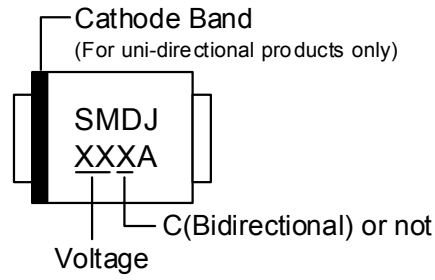

Package Information

Package Type	Description	Quantity (pcs)	Standard
SMC(DO-214AB)	Tape & Reel -16mm/13" tape	3000	EIA-481-D

CONTACT INFORMATION

No.1001, Shiwan(7) Road, Pudong District, Shanghai, P.R.China.201207

Tel: +86-21-68969993 Fax: 86-21-50757680 Email: market@way-on.com

WAYON website: <http://www.way-on.com>

For additional information, please contact your local Sales Representative.

**WAYON**® is registered trademarks of Wayon Corporation.

*Specifications are subject to change without notice.  
The device characteristics and parameters in this data sheet can and do vary in different applications and actual device performance may vary over time.  
Users should verify actual device performance in their specific applications.*

单击下面可查看定价，库存，交付和生命周期等信息

[>>WAY-ON\(维安\)](#)