



WE05MF-BH

Transient Voltage Suppressor

Features

- 80 Watts Peak Power per Line ($t_p = 8/20\mu s$)
- Protects two I/O lines
- Low operating voltage: 5V
- Low Leakage Current

IEC COMPATIBILITY (EN61000-4)

- IEC 61000-4-2 (ESD) $\pm 30kV$ (air), $\pm 30kV$ (contact)
- IEC 61000-4-4 (EFT) 40A (5/50ns)
- IEC 61000-4-5 (Lightning) 8A (8/20 μs)

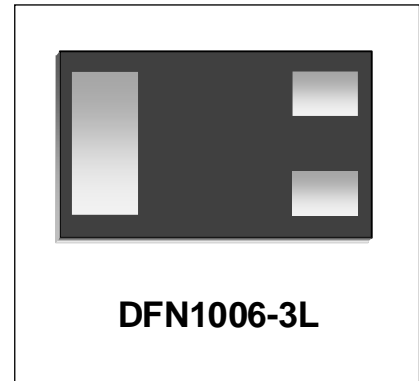

Mechanical Characteristics

- JEDEC DFN1006-3L package
- Marking : Making Code
- Packaging : Tape and Reel per EIA 481
- RoHS Compliant

Applications

- Cellular Handsets & Accessories
- Personal Digital Assistants (PDAs)
- Notebooks & Handhelds
- Portable Instrumentation
- Digital Cameras

Schematic & PIN Configuration

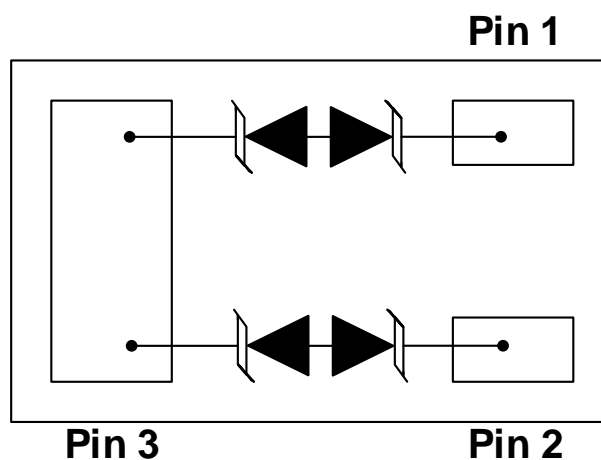

DFN1006-3L (Bottom View)

Absolute Maximum Rating			
Rating	Symbol	Value	Units
Peak Pulse Power ($t_p=8/20\mu s$)	P_{PP}	80	Watts
Peak Pulse Current ($t_p=8/20\mu s$)	I_{PP}	8	A
Operating Temperature	T_J	-55 to + 125	$^{\circ}C$
Storage Temperature	T_{STG}	-55 to +150	$^{\circ}C$

Electrical Parameters (T=25 $^{\circ}C$)

Symbol	Parameter
I_{PP}	Reverse Peak Pulse Current
V_C	Clamping Voltage @ I_{PP}
V_{RWM}	Reverse Stand-Off Voltage
I_R	Reverse Leakage Current @ V_{RWM}
V_{BR}	Breakdown Voltage @ I_T
I_T	Test Current

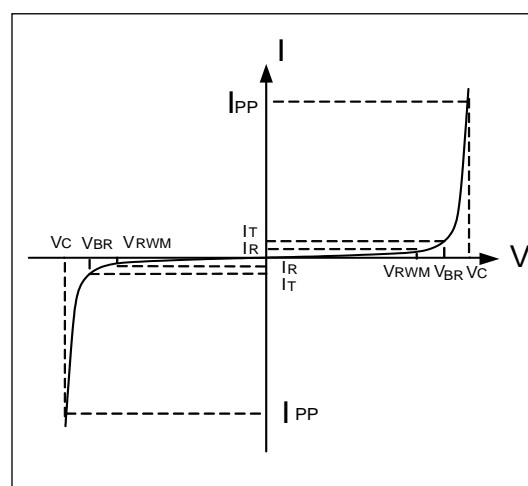

Electrical Characteristics

WE05MF-BH						
Parameter	Symbol	Conditions	Minimum	Typical	Maximum	Units
Reverse Stand-Off Voltage	V_{RWM}				5	V
Breakdown Voltage	V_{BR}	$I_T=1mA$	5.6		9	V
Reverse Leakage Current	I_R	$V_{RWM}=5V, T=25^{\circ}C$			100	nA
Clamping Voltage	V_C	$I_{PP}=8A, t_p=8/20\mu s$		8	10	V
Dynamic Resistance ^{1,2}	R_{DYN}	TLP=0.2/100ns		0.2		Ω
ESD Clamping Voltage ¹	V_C	$I_{PP} = 4A, t_p = 0.2/100ns$ (TLP)		6.1		V
ESD Clamping Voltage ¹	V_C	$I_{PP} = 16A, t_p = 0.2/100ns$ (TLP)		8.4		V
Junction Capacitance	C_j	Pin1 to 3 or Pin2 to 3 $V_R=0V, f=1MHz$		15	20	pF
		Pin1 to Pin2 $V_R=0V, f=1MHz$		7.5	10	pF

Notes : 1、 TLP Setting : $t_p=100ns, t_r=0.2ns, I_{TLP}$ and V_{TLP} sample window: $t_1=70ns$ to $t_2=90ns$.
 2、 Dynamic resistance calculated from $I_{PP}=4A$ to $I_{PP}=16A$ using "Best Fit".

Typical Characteristics

Figure 1: Peak Pulse Power vs. Pulse Time

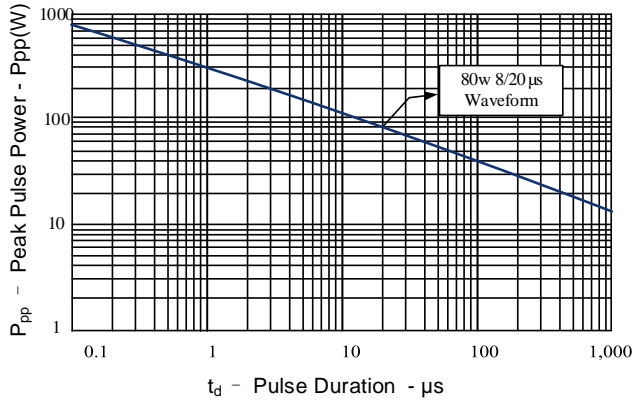

Figure 2: Power Derating Curve

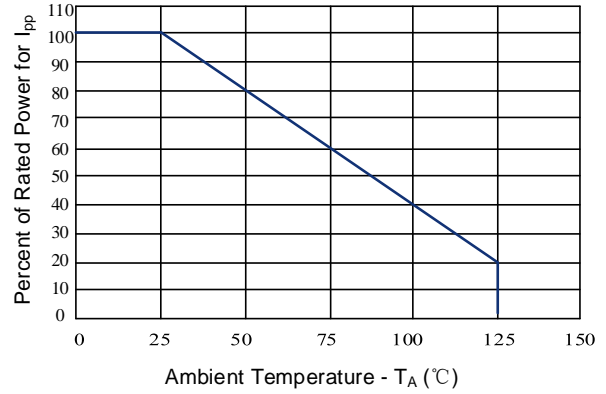

Figure 3: Clamping Voltage vs. Peak Pulse Current

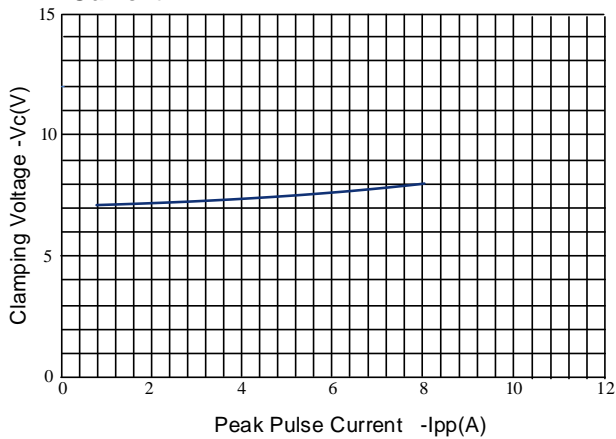

Figure 4: Normalized Junction Capacitance vs. Reverse Voltage

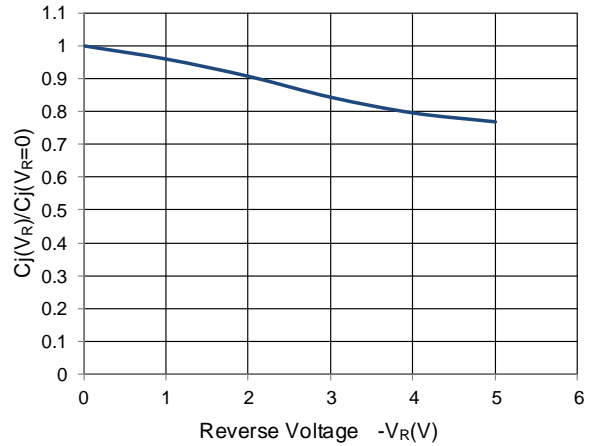

Figure 5: TLP Positive I-V Curve

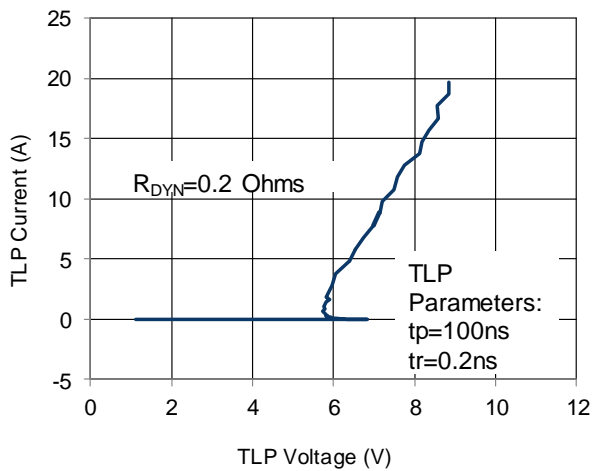
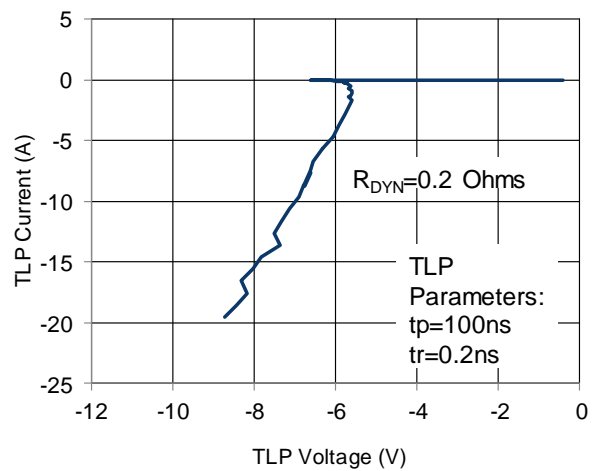
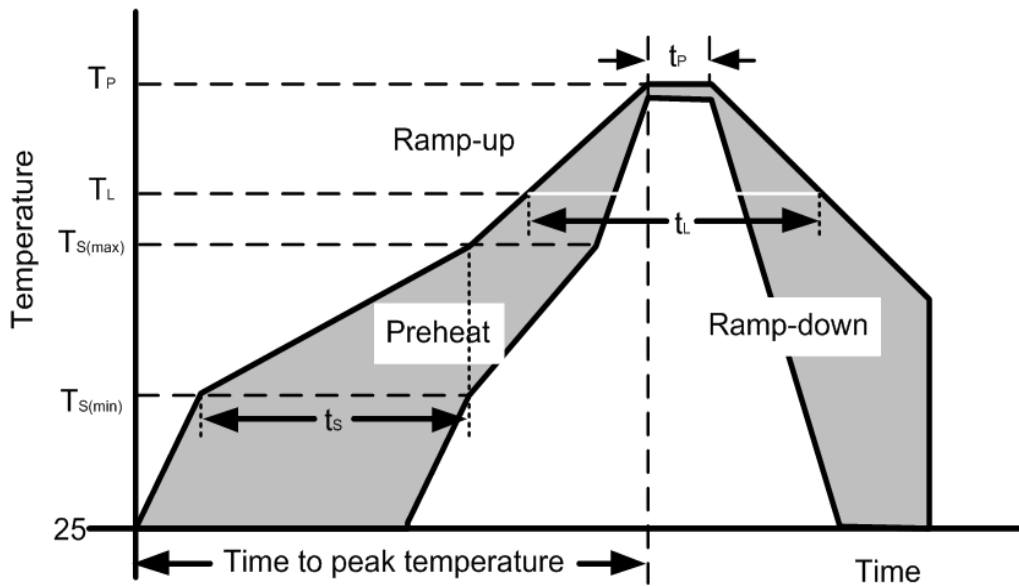

Figure 6: TLP Negative I-V Curve



Soldering Parameters

Reflow Condition		Pb – Free assembly
Pre Heat	Temperature Min ($T_{S(min)}$)	150°C
	Temperature Max ($T_{S(max)}$)	200°C
	Time (min to max) (t_s)	60 – 190 secs
Average ramp up rate (Liquidus Temp) (T_L) to peak		5°C/second max
$T_{S(max)}$ to T_L —Ramp-up Rate		5°C/second max
Reflow	Temperature (T_L) (Liquidus)	217°C
	Temperature (t_L)	60 – 150 seconds
Peak Temperature (T_P)		260+0/-5 °C
Time within actual peak Temperature (t_p)		20 – 40 seconds
Ramp-down Rate		5°C/second max
Time 25°C to peak Temperature (T_P)		8 minutes Max.
Do not exceed		280°C



Outline Drawing – DFN1006-3L

PACKAGE OUTLINE

DFN1006-3L

SYMBOL	MILLIMETERS		
	MIN	NOM	MAX
A	0.45	0.50	0.60
A1	0	0.02	0.05
b	0.45	0.50	0.55
b1	0.10	0.15	0.20
C	0.12	0.15	0.18
D	0.95	1.00	1.05
e	0.65BSC		
E	0.55	0.60	0.65
E1	0.15	0.20	0.25
L	0.20	0.25	0.30
L1	0.05REF		

Land Pattern

Marking Codes

Part Number	Marking Code
WE05MF-BH	<p>M=Specific Device Code X=Month Code</p>

Package Information

Qty: 10k/Reel

CONTACT INFORMATION

No.1001, Shiwan (7) Road, Pudong District, Shanghai, P.R.China.201207

Tel: 86-21-68969993 Fax: 86-21-50757680 Email: market@way-on.com

WAYON website: <http://www.way-on.com>

For additional information, please contact your local Sales Representative.

WAYON ® is registered trademark of Wayon Corporation.

Specifications are subject to change without notice.
The device characteristics and parameters in this data sheet can and do vary in different applications and actual device performance may vary over time.
Users should verify actual device performance in their specific applications.

单击下面可查看定价，库存，交付和生命周期等信息

[>>WAY-ON\(维安\)](#)