



WT3904DW

Dual NPN Transistor

Features

- Epitaxial Planar Die Construction
- Ideal for Low Power Amplification and Switching

Mechanical Characteristics

- SOT-363-6L Package
- Marking : Making Code
- RoHS Compliant

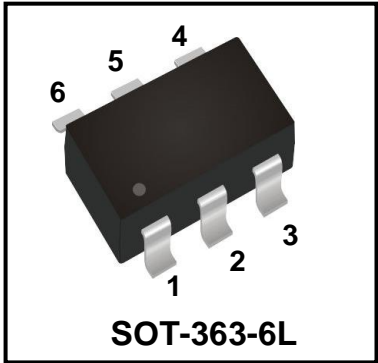

Schematic & PIN Configuration

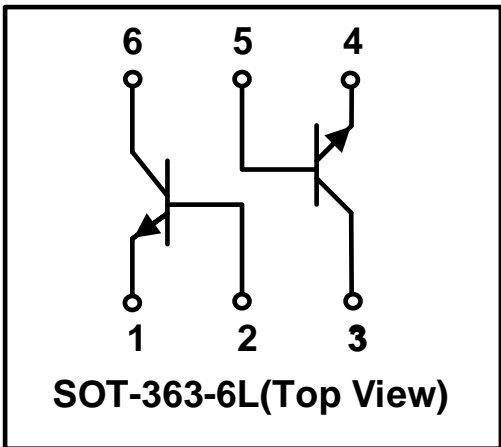

Absolute Maximum Rating

Parameter	Symbol	Value	Unit
Collector Base Voltage	V_{CBO}	60	V
Collector Emitter Voltage	V_{CEO}	40	V
Emitter Base Voltage	V_{EBO}	5	V
Collector Current Continuous	I_C	0.2	A
Collector Power Dissipation	P_C	0.2	W
Junction Temperature	T_J	150	°C
Storage Temperature	T_{STG}	-55 ~ 150	°C

Electrical Characteristics (Tamb=25°C unless otherwise noted)

Parameter	Symbol	Test Conditions	Min.	Typ.	Max.	Unit
Collector-Base Breakdown Voltage	$V_{(BR)CBO}$	$I_C = 10\mu A, I_E = 0$	60	-	-	V
Collector-Emitter Breakdown Voltage	$V_{(BR)CEO}$	$I_C = 1mA, I_B = 0$	40	-	-	V
Emitter-Base Breakdown Voltage	$V_{(BR)EBO}$	$I_E = 10\mu A, I_C = 0$	5	-	-	V
Collector Cut-off Current	I_{CBO}	$V_{CB} = 30V, I_E = 0$	-	-	50	nA
Collector Cut-off Current	I_{CEX}	$V_{CE} = 30V, V_{BE(off)} = 3V$	-	-	50	nA
Emitter Cut-off Current	I_{EBO}	$V_{EB} = 5V, I_C = 0$	-	-	50	nA
DC Current Gain	$h_{FE(1)}$	$V_{CE} = 1V, I_C = 0.1mA$	40	-	-	-
	$h_{FE(2)}$	$V_{CE} = 1V, I_C = 1mA$	70	-	-	-
	$h_{FE(3)}$	$V_{CE} = 1V, I_C = 10mA$	100	-	300	-
	$h_{FE(4)}$	$V_{CE} = 1V, I_C = 50mA$	60	-	-	-
	$h_{FE(5)}$	$V_{CE} = 1V, I_C = 100mA$	30	-	-	-
Collector-Emitter Saturation Voltage	$V_{CE(sat)}$	$I_C = 10mA, I_B = 1mA$	-	-	0.2	V
		$I_C = 50mA, I_B = 5mA$	-	-	0.3	
Base-Emitter Saturation Voltage	$V_{BE(sat)}$	$I_C = 10mA, I_B = 1mA$	0.65	-	0.85	V
		$I_C = 50mA, I_B = 5mA$	-	-	0.95	
Transition Frequency	f_T	$V_{CE}=20V, I_C=10mA, f=100MHz$	300	-	-	MHz
Collector Output Capacitance	C_{ob}	$V_{CB} = 5V, I_E = 0, f=1MHz$	-	3.5	-	pF
Noise Figure	NF	$V_{CE}=5V, I_C=0.1mA, f=1kHz, R_S=1K\Omega$	-	-	5	dB
Delay Time	t_d	$V_{CC} = 3V, V_{BE(off)} = -0.5V, I_C = 10mA, I_{B1} = -I_{B2} = 1mA$	-	30	-	nS
Rise Time	t_r		-	30	-	nS
Storage Time	t_s		-	180	-	nS
Fall Time	t_f	$I_{B1} = -I_{B2} = 1mA$	-	45	-	nS

Typical Characteristics

Figure 1. Capacitance

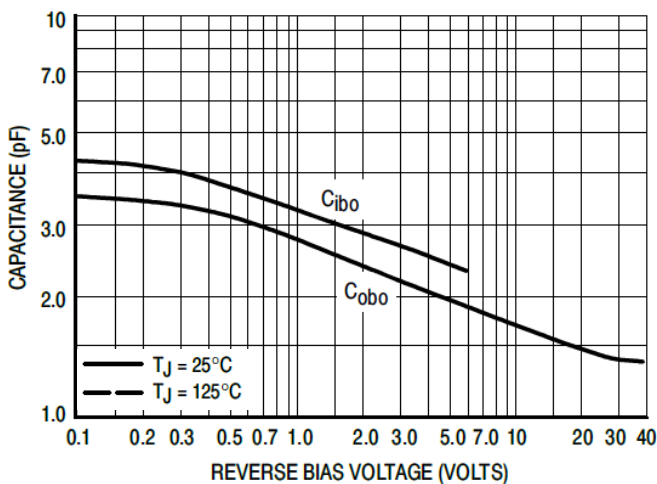

Figure 2. Charge Data

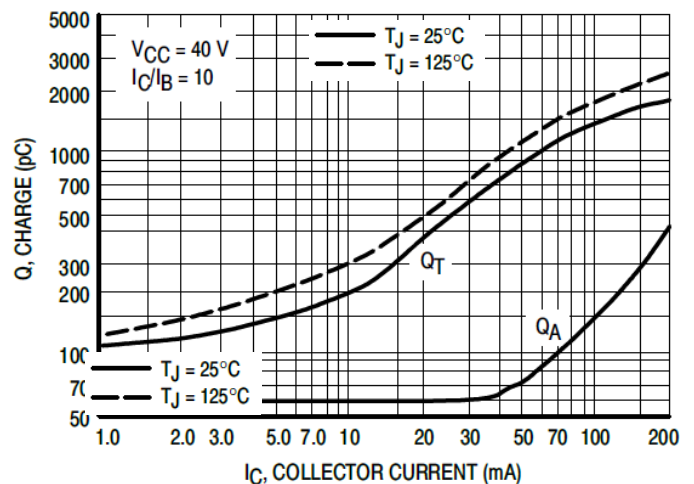

Figure 3. DC Current Gain

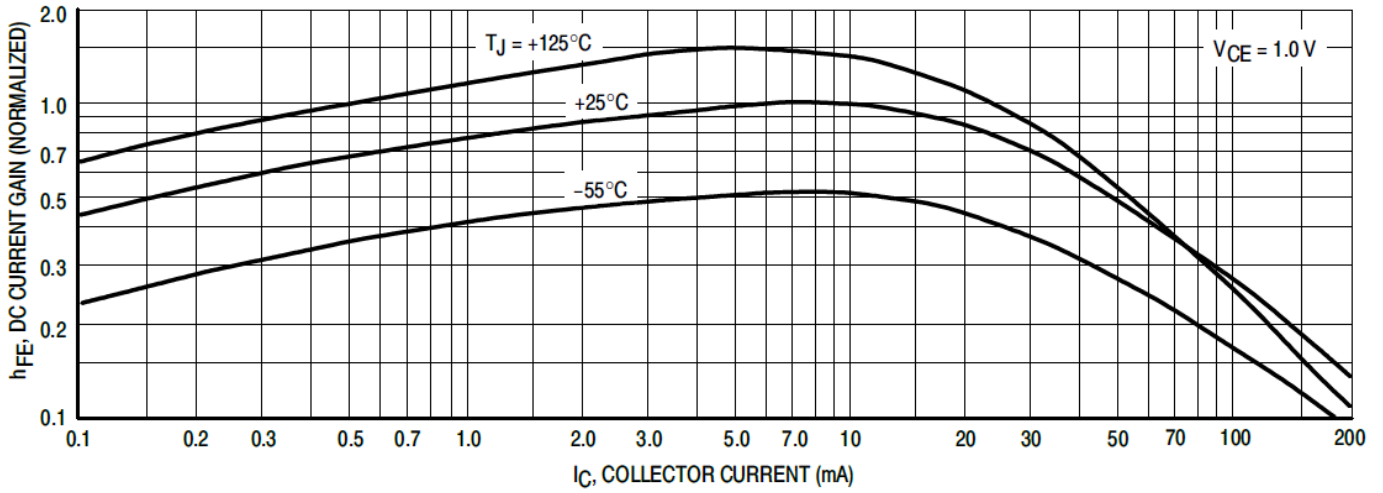

Figure 4. Collector Saturation Region

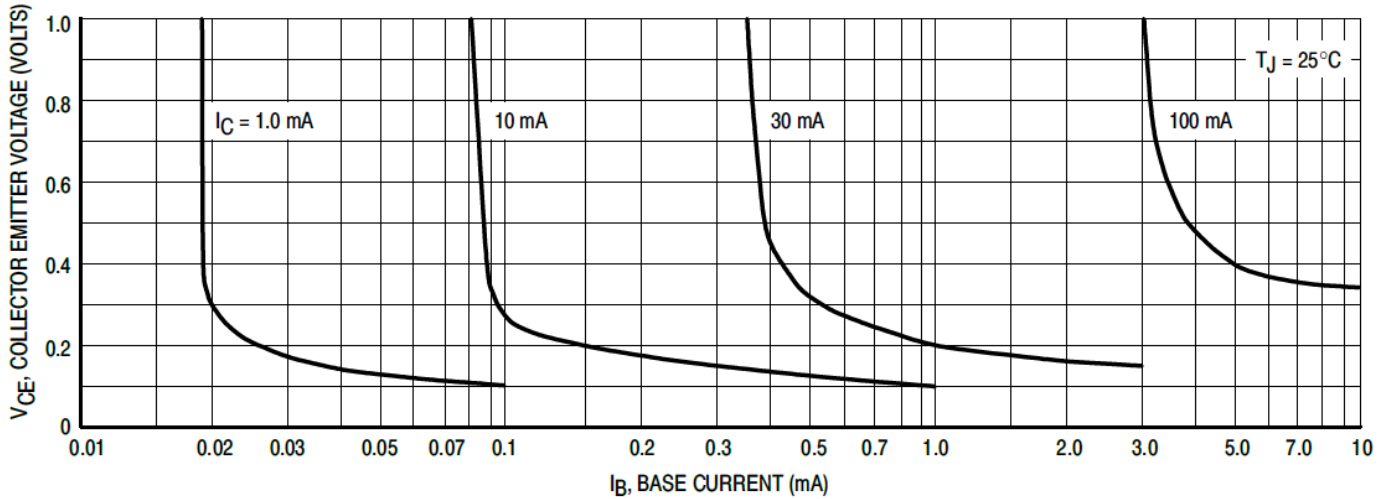

Figure 5. "ON" Voltages

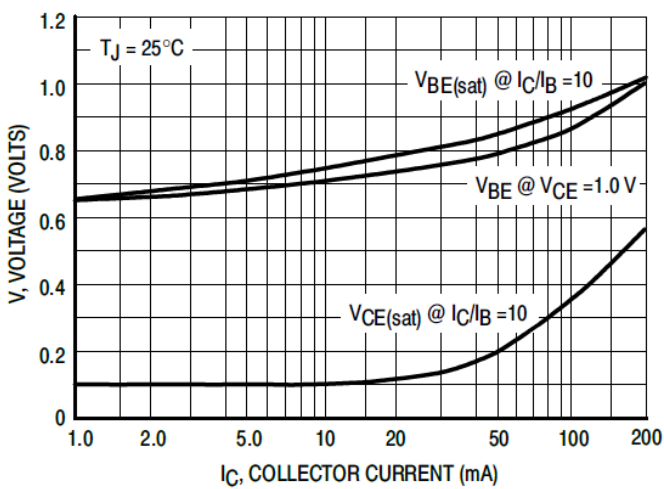
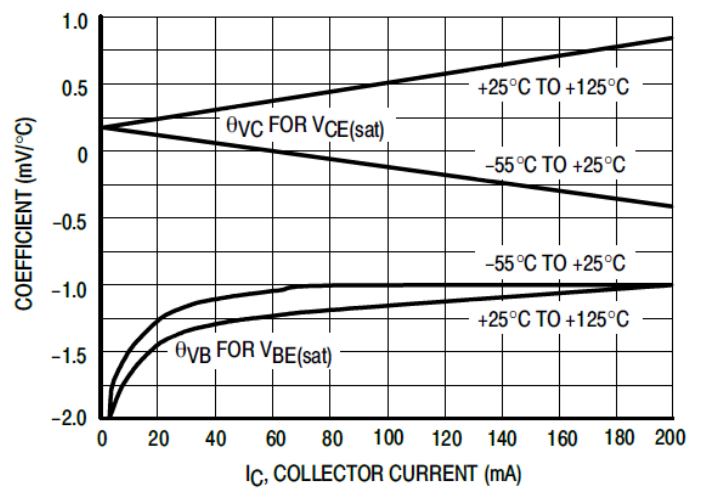

Figure 6. Temperature Coefficients



Outline Drawing – SOT-363-6L

PACKAGE OUTLINE

SYMBOL	INCHES		MILLIMETER	
	MIN	MAX	MIN	MAX
A	0.035	0.043	0.900	1.100
A1	0.000	0.004	0.000	0.100
A2	0.035	0.039	0.900	1.000
D	0.079	0.087	2.000	2.200
E1	0.045	0.053	1.150	1.350
E	0.085	0.096	2.150	2.450
e	0.026 TYP		0.650 TYP	
e1	0.047	0.055	1.200	1.400
L	0.021 REF		0.525 REF	
L1	0.010	0.018	0.260	0.460
θ	0°	8°	0°	8°

DIMENSIONS		
DIM	INCHES	MILLIMETERS
Z	0.090	2.30
G	0.073	1.85
P	0.020 TYP	0.65 TYP
X	0.008	0.20
Y	0.033	0.85

Notes

1. Dimensioning and tolerances per ANSI Y14.5M, 1985.
2. Controlling Dimension: Inches
3. Dimensions are exclusive of mold flash and metal burrs.

Marking Codes

Part Number	WT3904DW
Marking Code	

Package Information

Qty: 3k/Reel

CONTACT INFORMATION

No.1001, Shiwan (7) Road, Pudong District, Shanghai, P.R.China.201207

Tel: 86-21-68969993 Fax: 86-21-50757680 Email: market@way-on.com

WAYON website: <http://www.way-on.com>

For additional information, please contact your local Sales Representative.

WAYON® is registered trademark of Wayon Corporation.

Specifications are subject to change without notice.
The device characteristics and parameters in this data sheet can and do vary in different applications and actual device performance may vary over time.
Users should verify actual device performance in their specific applications.

单击下面可查看定价，库存，交付和生命周期等信息

[>>WAY-ON\(维安\)](#)