

Features

- High off-state impedance
- Low leakage current
- Quick response to surge voltage
- Eliminates over voltage caused by fast rising transients
- Short-circuit failure mode
- High surge capability: 8/20 μ s 3KA

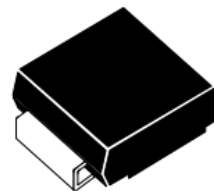

SMC
(JEDEC DO-214AB)

Main Application

- Base station antenna control.
- High-explored environment control lines.

Parameter	Symbol	Value	Unit
Maximum rated peak impulse current 8/20 μ s (IEC61000-4-5)	I_{PPSM}	3000	A
Maximum rated peak impulse voltage 1.2/50 μ s-8/20 μ s 2 Ω (IEC61000-4-5)	V_{PPSM}	6000	V

Electrical Parameters ($T_A=25^\circ\text{C}$)

Part Number	V_{DRM}	I_{DRM}	V_{BO}	I_{BO}	V_T	I_T	I_H	C_o
	Max.	Max.	Max.	Max.	Max.	Max.	Min.	Typ.
	V	μ A	V	mA	V	A	mA	pF
WES301420SC	400	5	530	800	4	2.2	20	500

V_{DRM} : Stand-off voltage, is measured at I_{DRM} .

I_{DRM} : Leakage current at V_{DRM} .

V_{BO} : Breakover voltage, is measured at 100V/ μ s.

I_{BO} : Breakover current.

V_T : On-state voltage.

I_T : On-state current.

C_o : Off-state capacitance.

I_H : Holding current.

I_{PPSM} : Peak pulse current, is a repetitive surge rating and is guaranteed for the life of the product.

V_{PPSM} : Peak pulse voltage, is a repetitive surge rating and is guaranteed for the life of the product.

General Notes:

- All measurements are made at an ambient temperature of 25 °C. IPP applies to -40 °C through +85 °C temperature range.
- Listed WES devices are bi-directional. All electrical parameters and surge ratings apply to forward and reverse polarities.
- Special voltage (VBO and VDRM) and holding current (IH) requirements are available up on request.
- Off-state capacitance is measured at 1 MHz with a 2 V bias.

Thermal Resistances

Symbol	Parameter	Value	Unit
Ts	Storage temperature range	-55 to +150	°C
Tj	Junction temperature range	-40 to +125	°C

Electrical Characteristics Curves

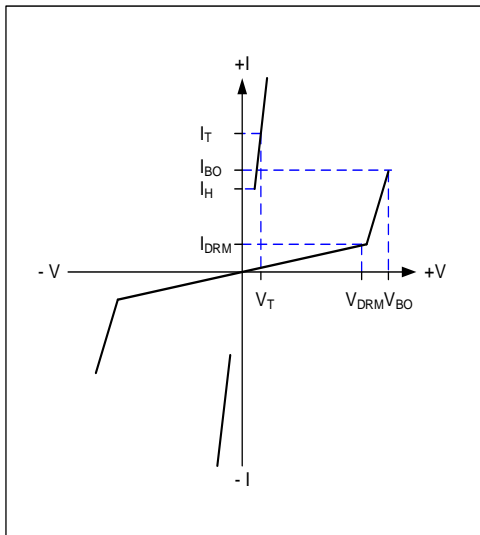

V - I Characteristics

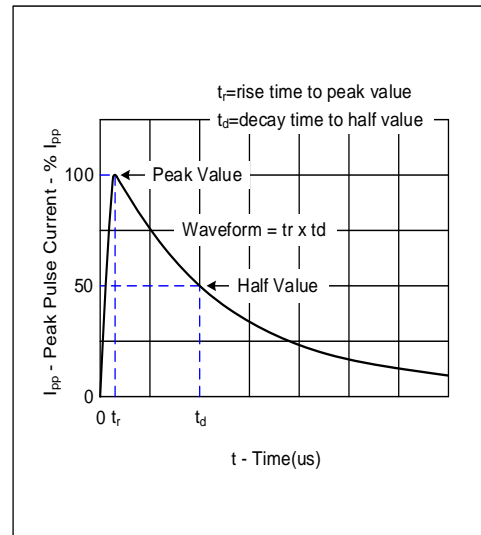

t_r X t_d Pulse Waveform

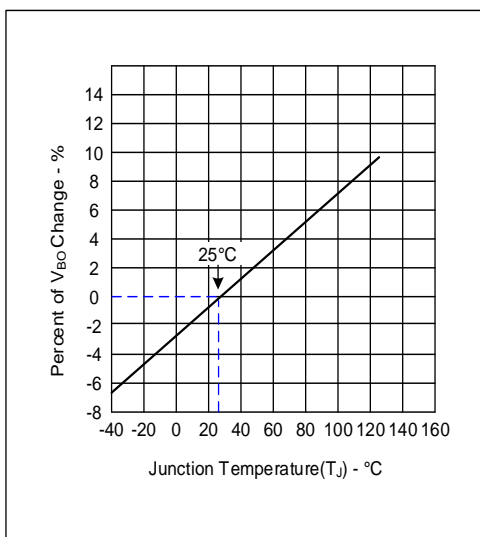

Normalized V_{BO} Change versus Junction Temperature

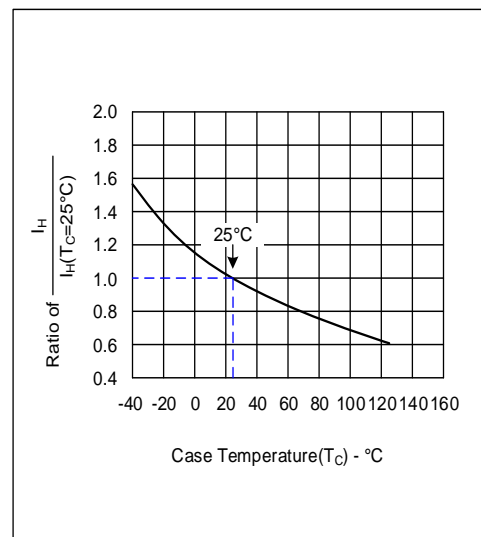

Normalized DC Holding Current versus Case Temperature

Soldering Parameters

Reflow Condition		
Pre Heat	Temperature Min ($T_{s(min)}$)	150°C
	Temperature Max ($T_{s(max)}$)	200°C
	Time (min to max) (t_s)	60-190 s
Average ramp up rate (Liquidus Temp (T_L) to peak)		3°C/s max
Ts(max) to TL - Ramp-up Rate		3°C/s max
Reflow	Temperature (T_L) (Liquidus)	217°C
	Temperature (t_L)	60-150 s
Peak Temperature (T_P)		260 ^{+0/-5} °C
Time within actual peak Temperature (t_p)		20-40 s
Ramp-down Rate		5°C/s max
Time 25°C to peak Temperature (T_P)		8 minutes Max.
Do not exceed		260°C

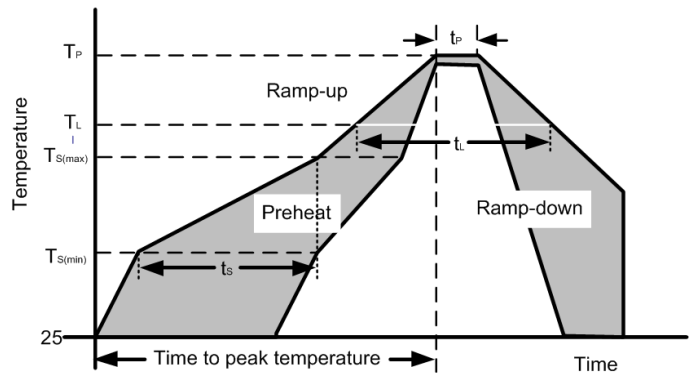

Product Dimensions

Ref. (mm)	Min.	Max.
A	2.06	2.70
A1	-	0.30
B	2.75	3.25
E	6.60	7.40
E1	7.70	8.20
D	5.59	6.25
L	0.76	1.52

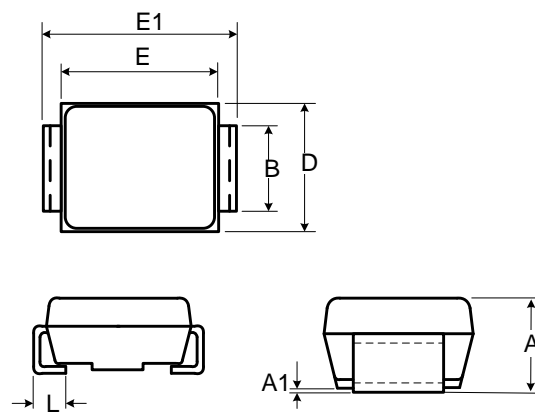

Recommended Solder Pad Layout

DIM(mm)	MILLIMETERS
A	4.2
B	3.3
C	2.4

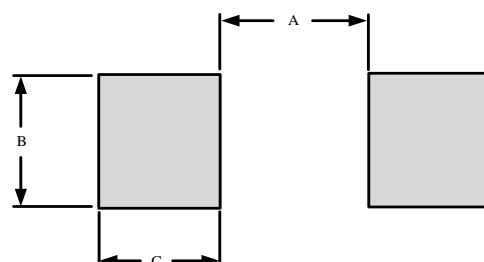

Part Numbering System and Marking

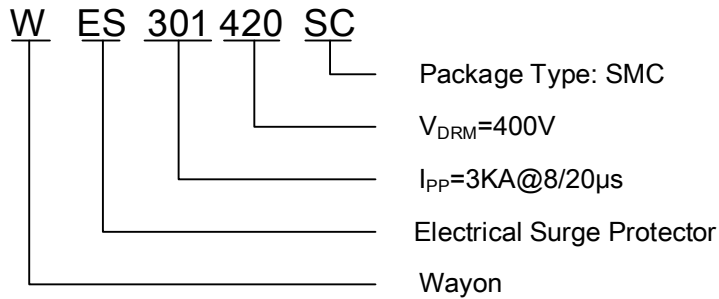

Marking:

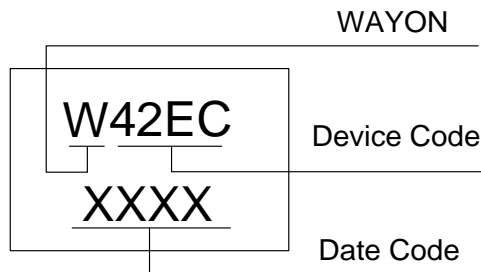

Package Information

Package Type	Description	Quantity (pcs)
SMC	Tape & Reel Pack	3000

Contact Information

No.1001, Shiwan(7) Road, Pudong District, Shanghai, P.R.China.201207

Tel: 021-68969993 Fax: 86-21-50757680 Email: market@way-on.com

WAYON website: <http://www.way-on.com>

For additional information, please contact your local Sales Representative.

WAYON® is registered trademarks of Wayon Corporation.

*Specifications are subject to change without notice.
 The device characteristics and parameters in this data sheet can and do vary in different applications and actual device performance may vary over time.
 Users should verify actual device performance in their specific applications.*

单击下面可查看定价，库存，交付和生命周期等信息

[>>WAY-ON\(维安\)](#)