

## 100V N-Channel Enhancement Mode Power MOSFET

### Description

WMB060N10HGS uses Wayon's advanced power trench MOSFET technology that has been especially tailored to minimize the on-state resistance and yet maintain superior switching performance. This device is well suited for high efficiency fast switching applications.

### Features

- $V_{DS} = 100V$ ,  $I_D = 95A$   
 $R_{DS(on)} < 6m\Omega @ V_{GS} = 10V$
- Green Device Available
- Low Gate Charge
- 100% EAS Guaranteed

### Applications

- Power Management Switches
- DC/DC Converter
- LED Backlighting

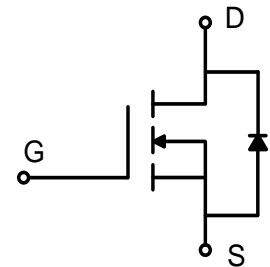
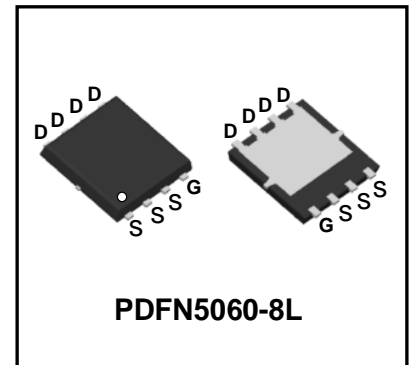

### Absolute Maximum Ratings (Tc = 25°C, unless otherwise noted)

Parameter		Symbol	Value	Unit
Drain-Source Voltage		$V_{DS}$	100	V
Gate-Source Voltage		$V_{GS}$	$\pm 20$	V
Continuous Drain Current <sup>1</sup>	Tc=25°C	$I_D$	95	A
	Tc=100°C		60	
Pulsed Drain Current <sup>4</sup>		$I_{DM}$	380	A
Single Pulse Avalanche Energy <sup>3</sup>		<b>EAS</b>	245	mJ
Total Power Dissipation	Tc=25°C	$P_D$	113.6	W
Operating Junction and Storage Temperature Range		$T_J, T_{STG}$	-55 to 150	°C

### Thermal Characteristics

Parameter	Symbol	Value	Unit
Thermal Resistance from Junction-to-Ambient <sup>1</sup>	$R_{\theta JA}$	60	°C/W
Thermal Resistance from Junction-to-Case	$R_{\theta JC}$	1.1	°C/W

**Electrical Characteristics (Tc = 25°C, unless otherwise noted)**

Parameter	Symbol	Test Conditions	Min.	Typ.	Max.	Unit	
<b>Static Characteristics</b>							
Drain-Source Breakdown Voltage	$V_{(BR)DSS}$	$V_{GS} = 0V, I_D = 250\mu A$	100	-	-	V	
Gate-body Leakage current	$I_{GSS}$	$V_{DS} = 0V, V_{GS} = \pm 20V$	-	-	$\pm 100$	nA	
Zero Gate Voltage Drain Current	$T_J=25^\circ C$	$I_{DSS}$	$V_{DS}=100V, V_{GS}=0V$	-	-	1	$\mu A$
	$T_J=100^\circ C$			-	-	100	
Gate-Threshold Voltage	$V_{GS(th)}$	$V_{DS} = V_{GS}, I_D = 250\mu A$	2	3	4	V	
Drain-Source on-Resistance <sup>2</sup>	$R_{DS(on)}$	$V_{GS} = 10V, I_D = 20A$	-	4.6	6	m $\Omega$	
Forward Transconductance <sup>2</sup>	$g_{fs}$	$V_{DS}=10V, I_D=20A$	-	58	-	S	
<b>Dynamic Characteristics</b>							
Input Capacitance	$C_{iss}$	$V_{DS} = 50V, V_{GS} = 0V, f = 1MHz$	-	5518	-	$\mu F$	
Output Capacitance	$C_{oss}$		-	655	-		
Reverse Transfer Capacitance	$C_{rss}$		-	23	-		
<b>Switching Characteristics</b>							
Gate Resistance	$R_g$	$V_{GS} = 0V, V_{DS} = 0V, f = 1MHz$	-	1.4	-	$\Omega$	
Total Gate Charge	$Q_g$	$V_{GS} = 10V, V_{DS} = 50V, I_D = 20A$	-	81.8	-	nC	
Gate-Source Charge	$Q_{gs}$		-	23.5	-		
Gate-Drain Charge	$Q_{gd}$		-	22.5	-		
Turn-on Delay Time	$t_{d(on)}$	$V_{GS} = 10V, V_{DS} = 50V, R_G = 3\Omega, I_D = 20A$	-	15.4	-	ns	
Rise Time	$t_r$		-	13	-		
Turn-off Delay Time	$t_{d(off)}$		-	34	-		
Fall Time	$t_f$		-	6.2	-		
<b>Drain-Source Body Diode Characteristics</b>							
Diode Forward Voltage <sup>2</sup>	$V_{SD}$	$I_F = 20A, V_{GS} = 0V$	-	-	1.2	V	
Continuous Source Current <sup>1,5</sup>	$I_S$	$V_G=V_D=0V$ , Force Current	-	-	95	A	
Body Diode Reverse Recovery Time	$t_{rr}$	$I_F = 20A, di/dt=100A/\mu s$	-	55	-	ns	
Body Diode Reverse Recovery Charge	$Q_{rr}$		-	101	-	nC	

## Notes:

- The data tested by surface mounted on a 1 inch<sup>2</sup> FR-4 board with 2OZ copper.
- The data tested by pulsed, pulse width  $\leq 300\mu s$ , duty cycle  $\leq 2\%$
- The EAS data shows Max. rating. The test condition is  $V_{DD}=50V, V_{GS}=10V, L=0.4mH, I_{AS}=35A$
- Repetitive rating, pulse width limited by junction temperature  $T_{J(MAX)}=150^\circ C$ .
- The data is theoretically the same as  $I_D$  and  $I_{DM}$ , in real applications, should be limited by total power dissipation.

Typical Characteristics

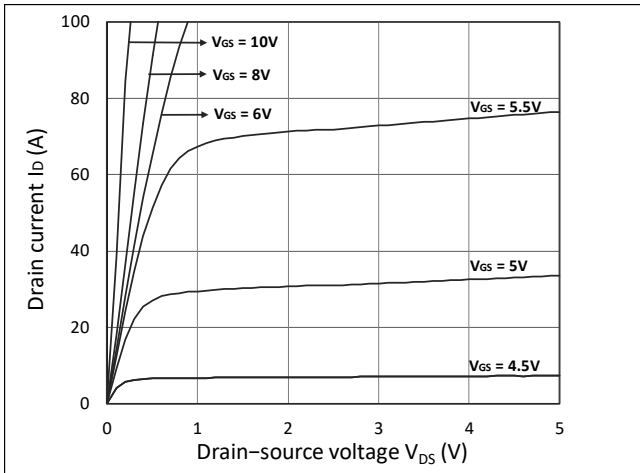

Figure 1. Output Characteristics

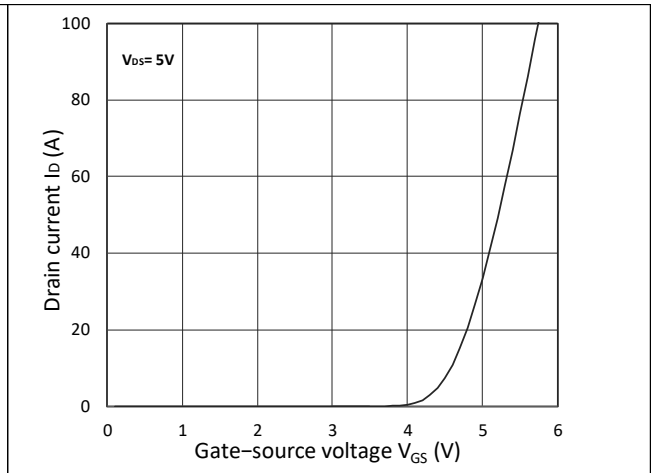

Figure 2. Transfer Characteristics

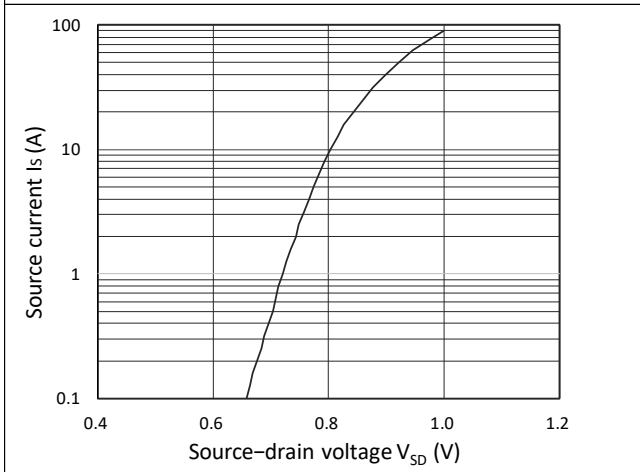

Figure 3. Forward Characteristics of Reverse

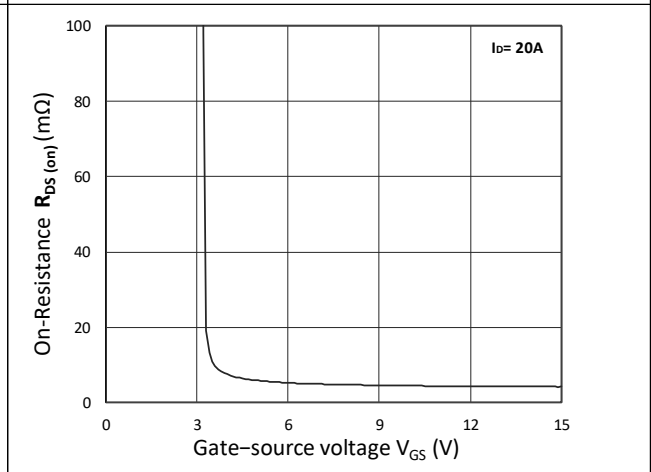

Figure 4.  $R_{DS(ON)}$  vs.  $V_{GS}$

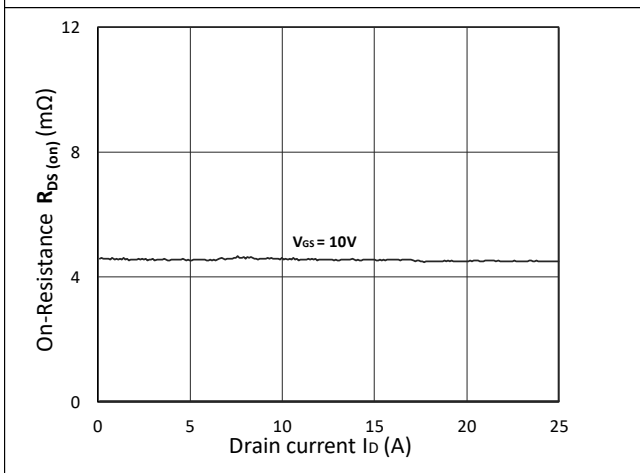

Figure 5.  $R_{DS(ON)}$  vs.  $I_D$

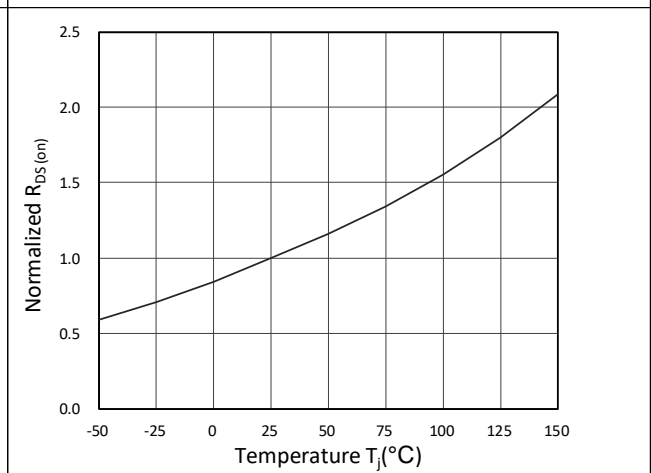

Figure 6. Normalized  $R_{DS(ON)}$  vs. Temperature

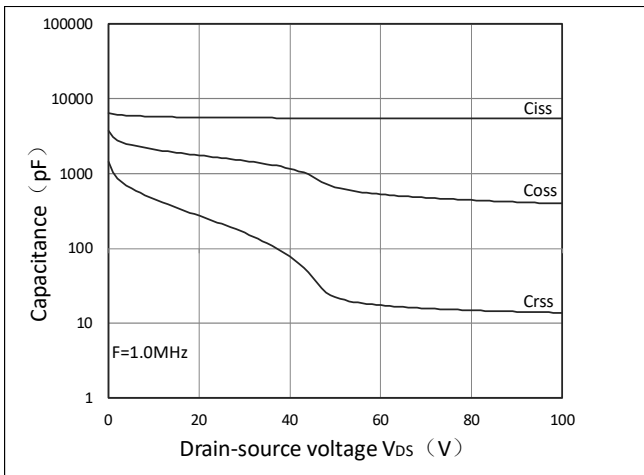

Figure 7. Capacitance Characteristics

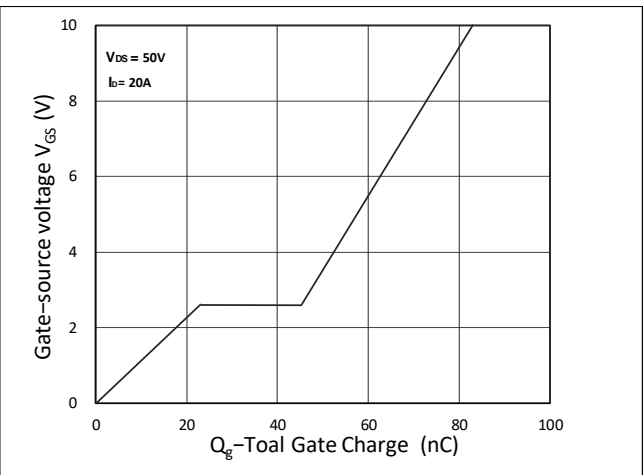

Figure 8. Gate Charge Characteristics

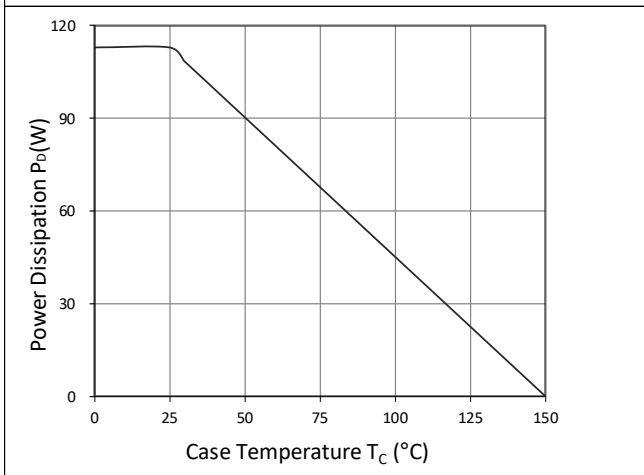

Figure 9. Power Dissipation

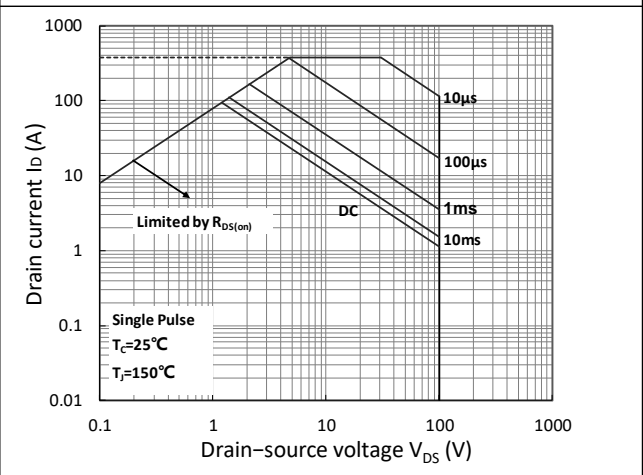

Figure 10. Safe Operating Area

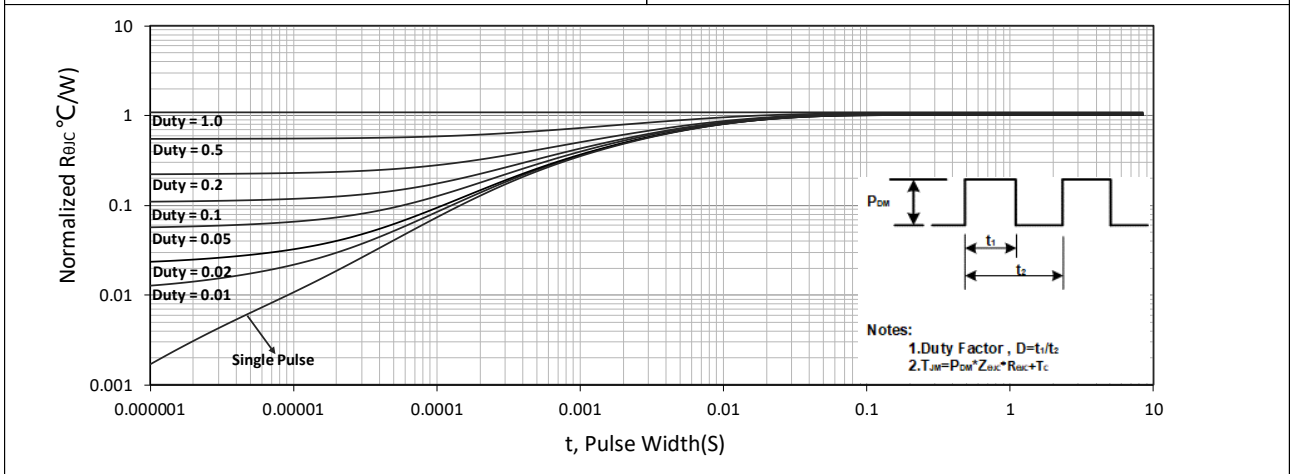

Figure 11. Normalized Maximum Transient Thermal Impedance

Test Circuit

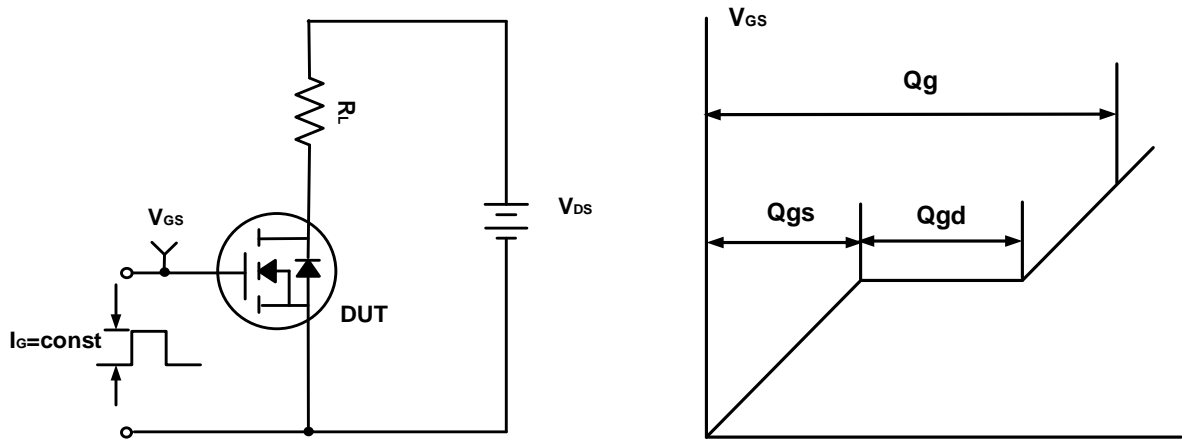

Figure A. Gate Charge Test Circuit & Waveforms

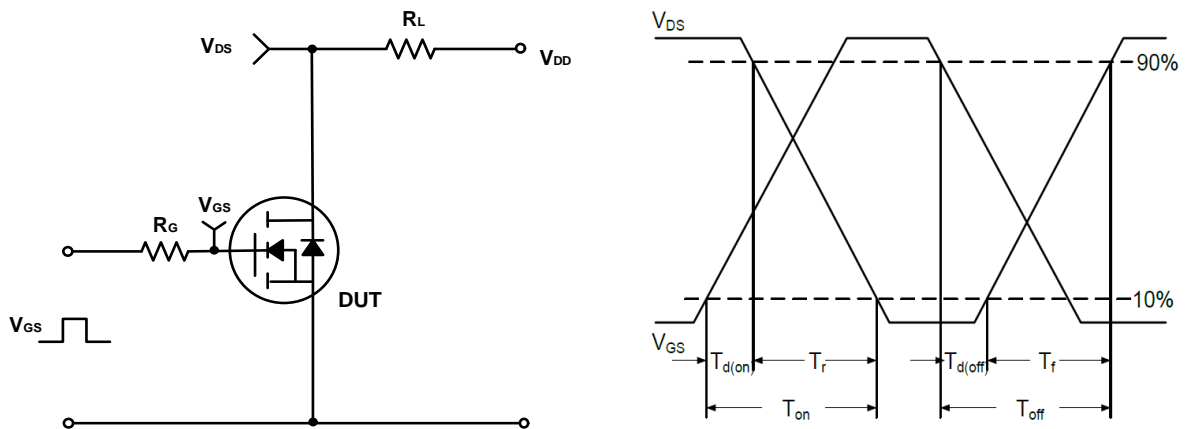

Figure B. Switching Test Circuit & Waveforms

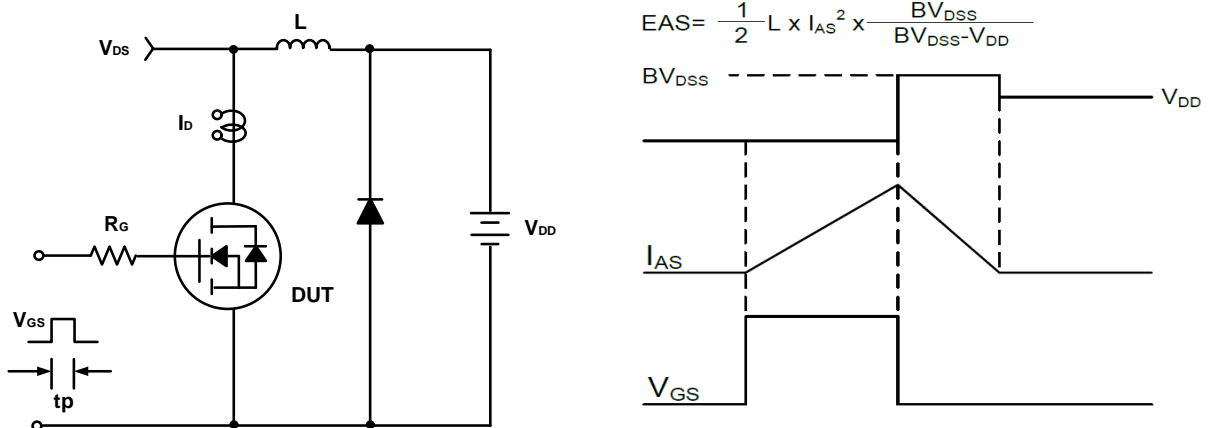
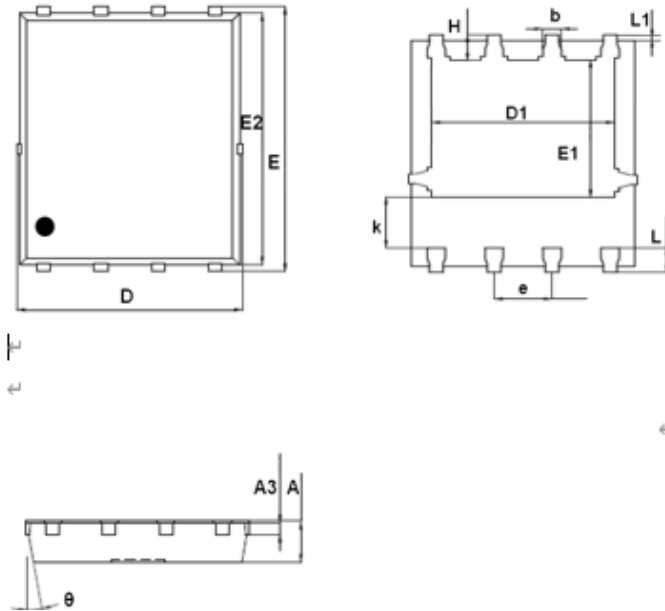

Figure C. Unclamped Inductive Switching Circuit & Waveforms

## Mechanical Dimensions for PDFN5060-8L

## COMMON DIMENSIONS



SYMBOL	MM	
	MIN	MAX
A	0.90	1.20
A3	0.15	0.35
D	4.80	5.40
E	5.90	6.35
D1	3.61	4.31
E1	3.30	3.92
E2	5.50	6.06
k	1.10	-
b	0.30	0.51
e	1.27BSC	
L	0.38	0.71
L1	0.05	0.36
H	0.38	0.71
$\Theta$	0°	12°

## Ordering Information

Part	Package	Marking	Packing method
WMB060N10HGS	PDFN5060-8L	060N10HS	Tape and Reel

## Marking Information

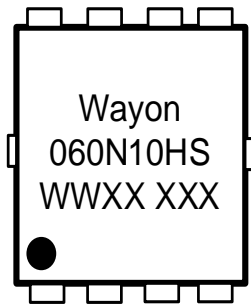

060N10HS = Device code

WWXX XXX= Date code

## Contact Information

No.1001, Shiwan(7) Road, Pudong District, Shanghai, P.R.China.201207

Tel: 86-21-50310888 Fax: 86-21-50757680 Email: market@way-on.com

WAYON website: <http://www.way-on.com>

For additional information, please contact your local Sales Representative.

 ® is registered trademarks of Wayon Corporation.

## Disclaimer

WAYON reserves the right to make changes without further notice to any Products herein to improve reliability, function, or design. The Products are not designed for use in hostile environments, including, without limitation, aircraft, nuclear power generation, medical appliances, and devices or systems in which malfunction of any Product can reasonably be expected to result in a personal injury. The information given in this document shall in no event be regarded as a guarantee of conditions or characteristics. WAYON does not assume any liability for infringement of patents, copyrights, or other intellectual property rights of third parties by or arising from the use of Products or technical information described in this document.

单击下面可查看定价，库存，交付和生命周期等信息

[>>WAY-ON\(维安\)](#)