



WEOS4-100/XXAS

Thyristor Surge Protector

Features

- Bi-directional crowbar transient voltage protection
- High surge capability
- High off-state impedance, Low leakage current
- Short-circuit failure mode
- Low on-state voltage

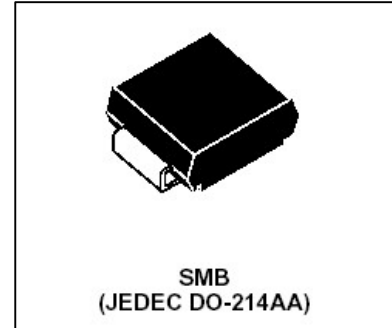

Main Application

WAYON's thyristor surge protector devices are designed to help protect sensitive telecommunication equipment from the hazards caused by lightning, power contact, and power induction. These devices enable equipment to comply with various regulatory requirements including GR 1089, ITU K.20, K.21 and K.45, IEC 60950, UL 60950, and TIA-968-A (formerly known as FCC Part 68).

Typical application including:

- Central office switching equipment, Analog and digital linecards (xDSL, T1/E1, ISDN...).
- Customer Premises Equipment (CPE) such as phones, fax machines, modems, POS terminals, PBX systems and caller ID adjunct boxes.
- Primary protection modules including Main Distribution Frames (MDF), building entrance equipment and station protection modules.
- Access network equipment such as remote terminals, line repeaters, multiplexers, cross-connects, WAN equipment, Network Interface Devices (NID).
- Data lines and security systems.
- CATV line amplifiers and power inserters.
- Sprinkler systems.

Absolute Maximum Ratings (TA =25°C)

Parameter	Symbol	Value	Unit
Non-repetitive peak impulse current 10/1000 μ s (Telcordia GR-1089-CORE)	I_{PPSM}	100	A
Non-repetitive peak impulse Voltage 10/700 μ s (ITU-T K.20, K.21 & K.44, K.45)	V_{PPSM}	6000	V
Operating Junction Temperature range	T_J	-40 to + 125	°C
Storage Temperature range	T_s	-55 to + 150	°C

Electrical Parameters (TA =25°C)

Part Number	Marking code	V _{DRM}	I _{DRM}	V _{BO}	I _{BO}	V _T	I _T	C _O	I _H
		Max.	Max.	Max.	Max.	Max.	Max.	Typ.	Min.
		V	μA	V	mA	V	A	pF	mA
WEOS4-100/15AS	W02SC	15	5	25	800	4	2.2	110	50
WEOS4-100/25AS	W03SC	25	5	40	800	4	2.2	110	50
WEOS4-100/58AS	W06SC	58	5	77	800	4	2.2	100	120
WEOS4-100/65AS	W07SC	65	5	88	800	4	2.2	40	120
WEOS4-100/75AS	W09SC	75	5	98	800	4	2.2	90	120
WEOS4-100/90AS	W11SC	90	5	130	800	4	2.2	80	120
WEOS4-100/100AS	W12SC	100	5	130	800	4	2.2	80	120
WEOS4-100/120AS	W14SC	120	5	160	800	4	2.2	80	120
WEOS4-100/140AS	W15SC	140	5	180	800	4	2.2	80	120
WEOS4-100/170AS	W18SC	170	5	220	800	4	2.2	60	120
WEOS4-100/180AS	W20SC	180	5	220	800	4	2.2	60	120
WEOS4-100/190AS	W23SC	190	5	260	800	4	2.2	60	120
WEOS4-100/220AS	W26SC	220	5	300	800	4	2.2	60	120
WEOS4-100/230AS	W28SC	230	5	290	800	4	2.2	60	120
WEOS4-100/270AS	W31SC	270	5	350	800	4	2.2	60	120
WEOS4-100/300AS	W35SC	320	5	400	800	4	2.2	60	120
WEOS4-100/350AS	W36SC	350	5	460	800	4	2.2	45	120

V_{DRM}: Stand-off voltage, is measured at I_{DRM}.

I_{DRM}: Leakage current at V_{DRM}.

V_{BO}: Breakover voltage, is measured at 100V/μs.

I_{BO}: Breakover current.

V_T: On-state voltage.

I_T: On-state current.

C_O: Off-state capacitance.

I_H: Holding current.

I_{PP}: Peak pulse current, is a repetitive surge rating and is guaranteed for the life of the product.

V_{PPSM}: Peak pulse voltage, is a repetitive surge rating and is guaranteed for the life of the product.

General Notes:

- All measurements are made at an ambient temperature of 25 °C. I_{PP} applies to -40 °C through +85 °C temperature range.
- WEOS4 devices are bi-directional. All electrical parameters and surge ratings apply to forward and reverse polarities.
- Special voltage (V_{BO} and V_{DRM}) and holding current (I_H) requirements are available up on request. Off-state capacitance is measured at 1 MHz with a 2 V bias.

Electrical Characteristics Curves

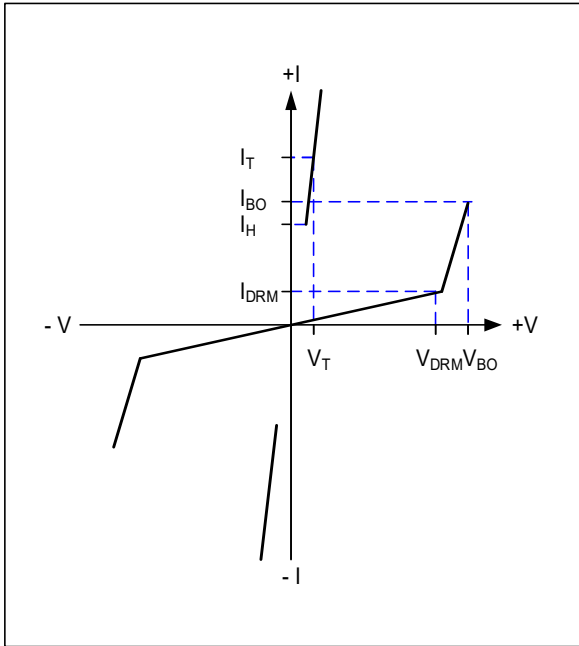

V - I Characteristics

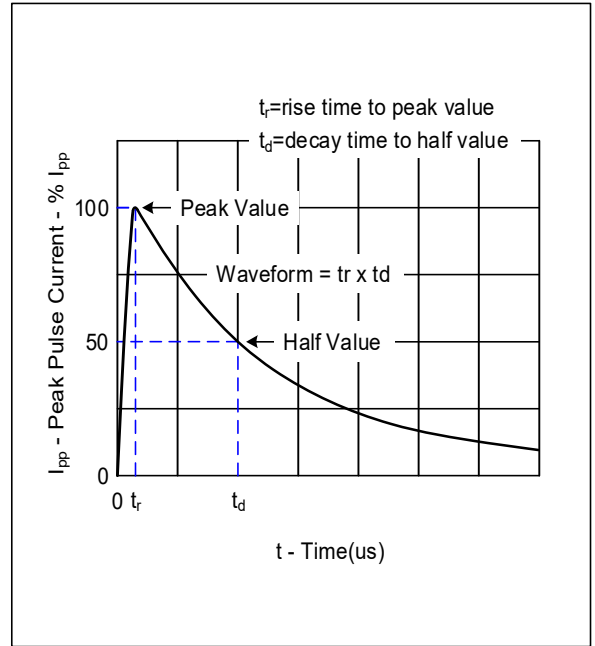

$t_r \times t_d$ Pulse Waveform

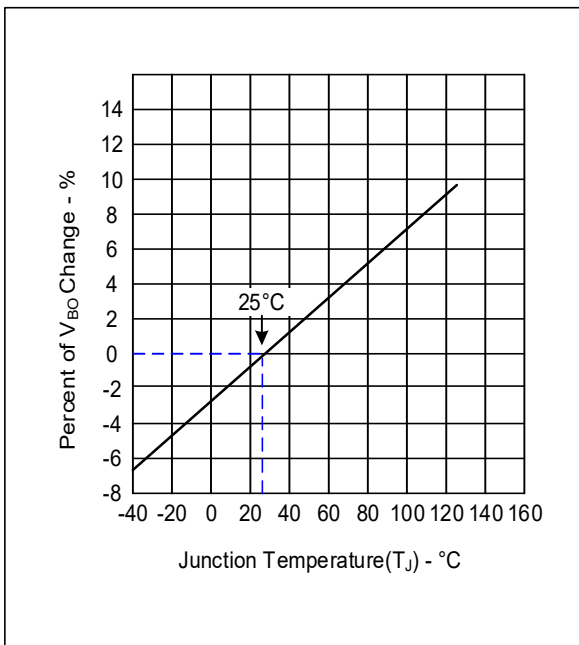

Normalized V_{BO} Change versus Junction Temperature

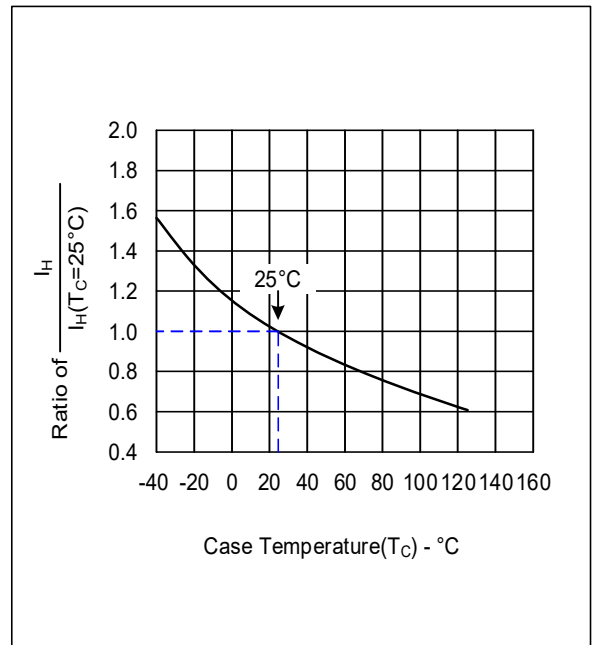

Normalized DC Holding Current versus Case Temperature

Soldering Parameters

Reflow Condition		
Pre Heat	Temperature Min ($T_{s(min)}$)	150°C
	Temperature Max ($T_{s(max)}$)	200°C
	Time (min to max) (t_s)	60-190 s
Average ramp up rate (Liquidus Temp) (T_L) to peak		3°C/s max
Ts(max) to TL - Ramp-up Rate		3°C/s max
Reflow	Temperature (T_L) (Liquidus)	217°C
	Temperature (t_L)	60-150 s
Peak Temperature (T_P)		260 ^{+0/-5} °C
Time within actual peak Temperature (t_p)		20-40 s
Ramp-down Rate		5°C/s max
Time 25°C to peak Temperature (T_P)		8 minutes Max.
Do not exceed		260°C

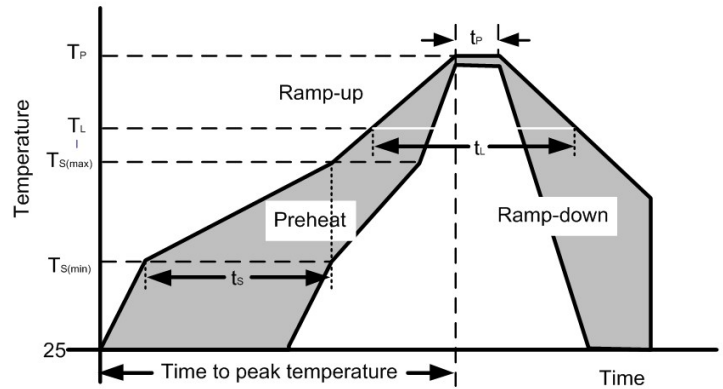

Product Dimensions

Ref. (mm)	Min.	Max.
A	2.130	2.600
A1	-	0.300
B	1.900	2.200
E	4.100	4.750
E1	5.210	5.590
D	3.300	3.940
L	0.760	1.520

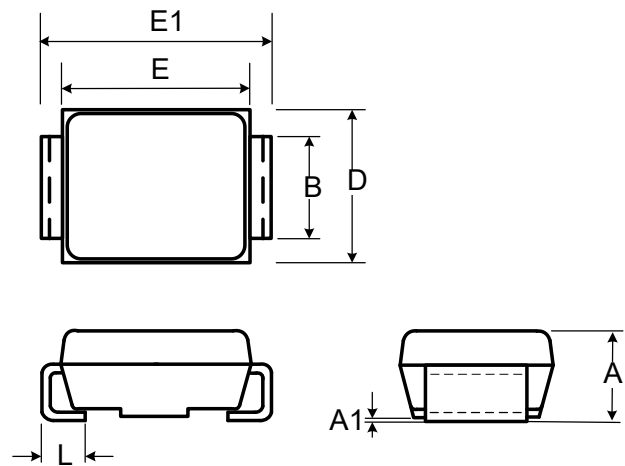

Recommended Solder Pad Layout

DIM(mm)	MILLIMETERS
A	2.74
B	2.26
C	2.16

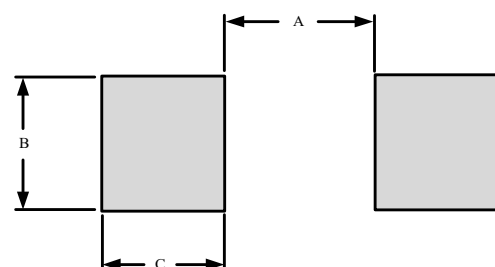

Part Numbering System and Marking

W E O S 4 – 1 0 0 / X X A S

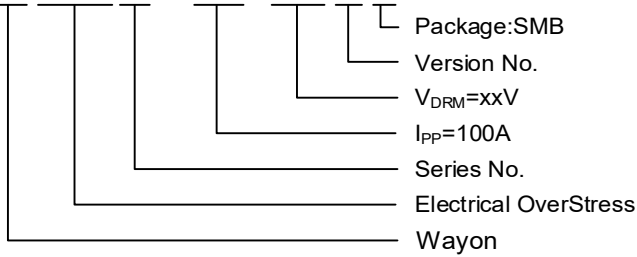

Marking:

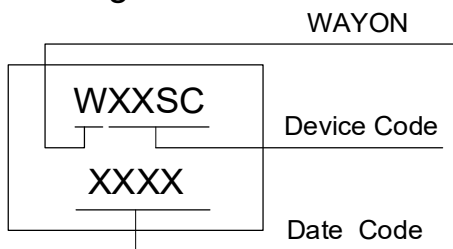

Package Information

Package Type	Description	Quantity (pcs)
SMB(DO-214AA)	Tape & Reel Pack	2500

Contact Information

No.1001, Shiwan(7) Road, Pudong District, Shanghai, P.R.China.201207

Tel: 021-68969993 Fax: 86-21-50757680 Email: market@way-on.com

WAYON website: <http://www.way-on.com>

For additional information, please contact your local Sales Representative.

WAYON® is registered trademarks of Wayon Corporation.

*Specifications are subject to change without notice.
The device characteristics and parameters in this data sheet can and do vary in different applications and actual device performance may vary over time.
Users should verify actual device performance in their specific applications.*

单击下面可查看定价，库存，交付和生命周期等信息

[>>WAY-ON\(维安\)](#)