

### Features

- 450 Watts Peak Pulse Power per Line ( $t_p=8/20\mu s$ )
- Small Body Outline Dimensions
- Protects one I/O or power line
- Working Voltage: 5.5V
- Low Leakage Current

### IEC COMPATIBILITY (EN61000-4)

- IEC 61000-4-2 (ESD)  $\pm 30kV$  (air),  $\pm 30kV$  (contact)
- IEC 61000-4-4 (EFT) 40A (5/50ns)
- IEC 61000-4-5 (Lightning) 50A (8/20 $\mu s$ )

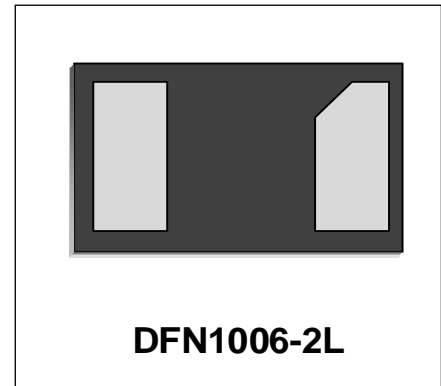

### Mechanical Characteristics

- DFN1006-2L package
- Marking : Marking Code
- Packaging : Tape and Reel per EIA 481
- RoHS Compliant & HF
- Device meets MSL1 requirement

### Applications

- Cellular Handsets & Accessories
- Personal Digital Assistants (PDAs)
- Notebooks & Handhelds
- Portable Instrumentation
- Digital Cameras

### Schematic & PIN Configuration

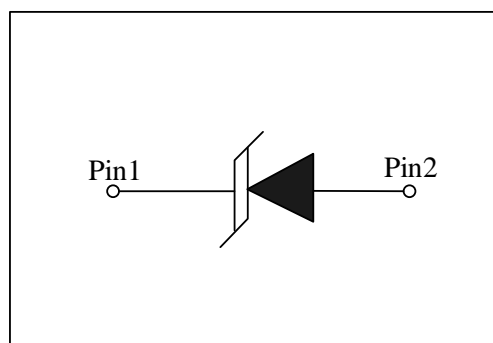

**Absolute Maximum Rating**

Rating	Symbol	Value	Units
Peak Pulse Power ( $t_p = 8/20\mu s$ )	P <sub>PP</sub>	450	Watts
Peak Pulse Current ( $t_p = 8/20\mu s$ )	I <sub>PP</sub>	50	A
Operating Temperature	T <sub>J</sub>	-55 to + 125	°C
Storage Temperature	T <sub>STG</sub>	-55 to +150	°C

**Electrical Parameters**

Symbol	Parameter
I <sub>PP</sub>	Reverse Peak Pulse Current
V <sub>C</sub>	Clamping Voltage @ I <sub>PP</sub>
V <sub>RWM</sub>	Reverse Stand-Off Voltage
I <sub>R</sub>	Reverse Leakage Current @ V <sub>RWM</sub>
V <sub>BR</sub>	Breakdown Voltage @ I <sub>T</sub>
I <sub>T</sub>	Test Current
I <sub>F</sub>	Forward Current
V <sub>F</sub>	Forward Voltage @ I <sub>F</sub>

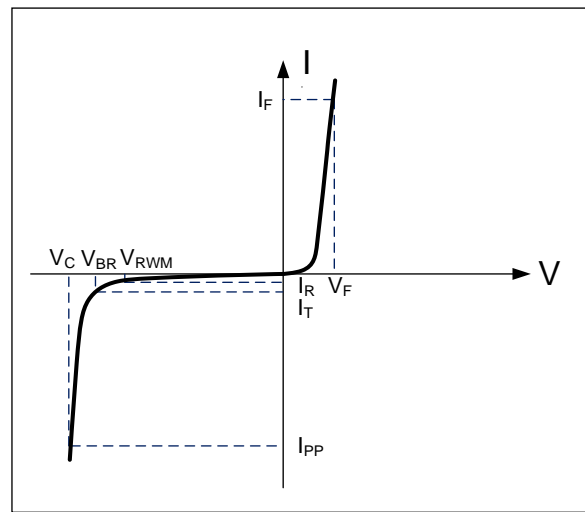

**Electrical Characteristics (T<sub>A</sub>=25°C unless otherwise noted)**

WS5.5DFVH						
Parameter	Symbol	Conditions	Minimum	Typical	Maximum	Units
Reverse Stand-Off Voltage	V <sub>RWM</sub>				5.5	V
Reverse Breakdown Voltage	V <sub>BR</sub>	I <sub>T</sub> =1mA	5.7		8	V
Reverse Leakage Current	I <sub>R</sub>	V <sub>RWM</sub> =5.5V			500	nA
Forward Voltage	V <sub>F</sub>	I <sub>F</sub> =10mA	0.5		1.2	V
Clamping Voltage	V <sub>C</sub>	I <sub>PP</sub> =50A, t <sub>p</sub> =8/20μs		7.5	9	V
Dynamic Resistance <sup>1,2</sup>	R <sub>DYN</sub>	TLP=0.2/100ns		0.05		Ω
ESD Clamping Voltage <sup>1</sup>	V <sub>C</sub>	I <sub>PP</sub> = 4A, t <sub>p</sub> = 0.2/100ns (TLP)		5.9		V
ESD Clamping Voltage <sup>1</sup>	V <sub>C</sub>	I <sub>PP</sub> = 16A, t <sub>p</sub> = 0.2/100ns (TLP)		6.5		V
Junction Capacitance	C <sub>j</sub>	V <sub>R</sub> = 0V, f = 1MHz		160	200	pF

**Note:** 1、 TLP Setting : t<sub>p</sub>=100ns, t<sub>r</sub>=0.2ns, I<sub>TLP</sub> and V<sub>TLP</sub> sample window:t<sub>1</sub>=70ns to t<sub>2</sub>=90ns.  
 2、 Dynamic resistance calculated from I<sub>PP</sub>=4A to I<sub>PP</sub>=16A using "Best Fit"

Typical Characteristics

Figure 1: Peak Pulse Power vs. Pulse Time

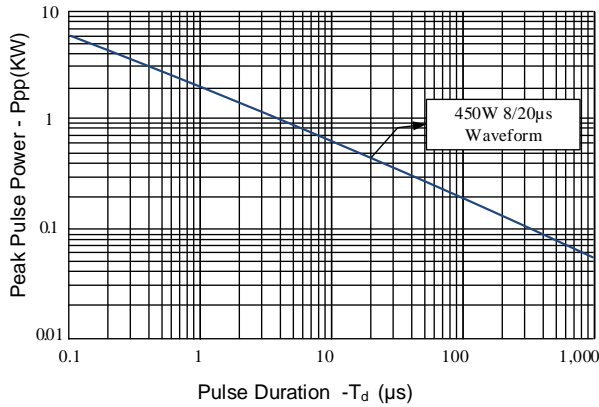

Figure 2: Power Derating Curve

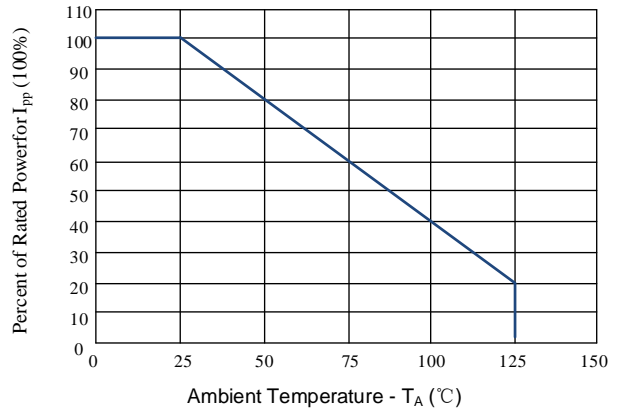

Figure 3: Clamping Voltage vs. Peak Pulse Current

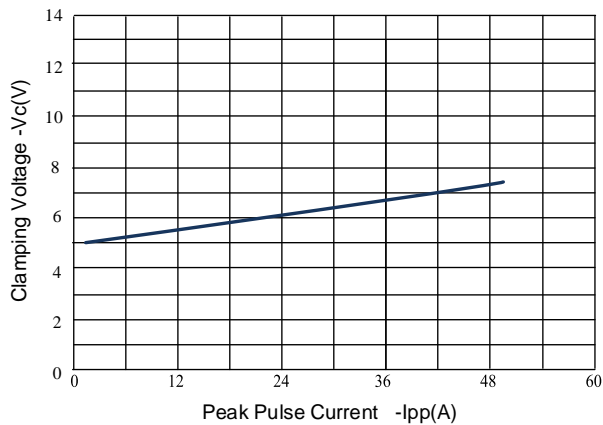

Figure 4: Normalized Junction Capacitance vs. Reverse Voltage

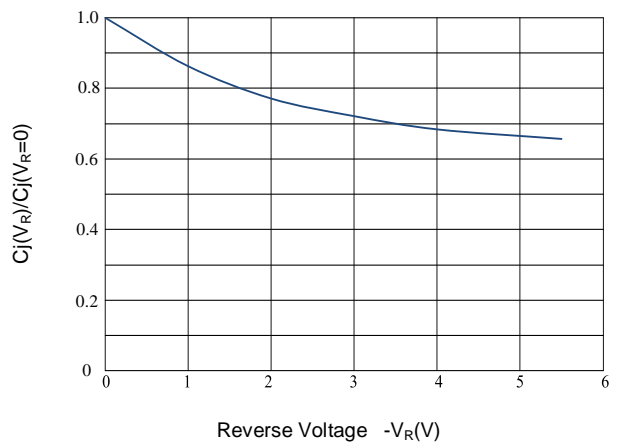

Figure 5: 8/20μs Pulse Waveform

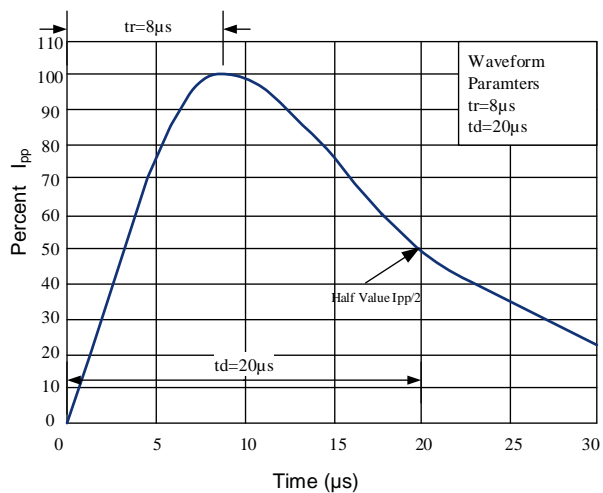
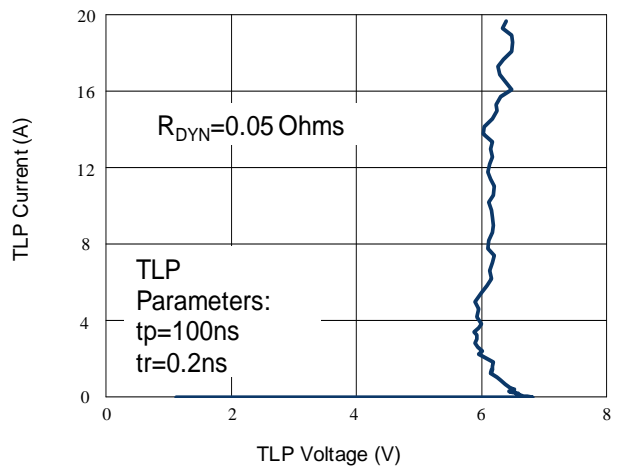
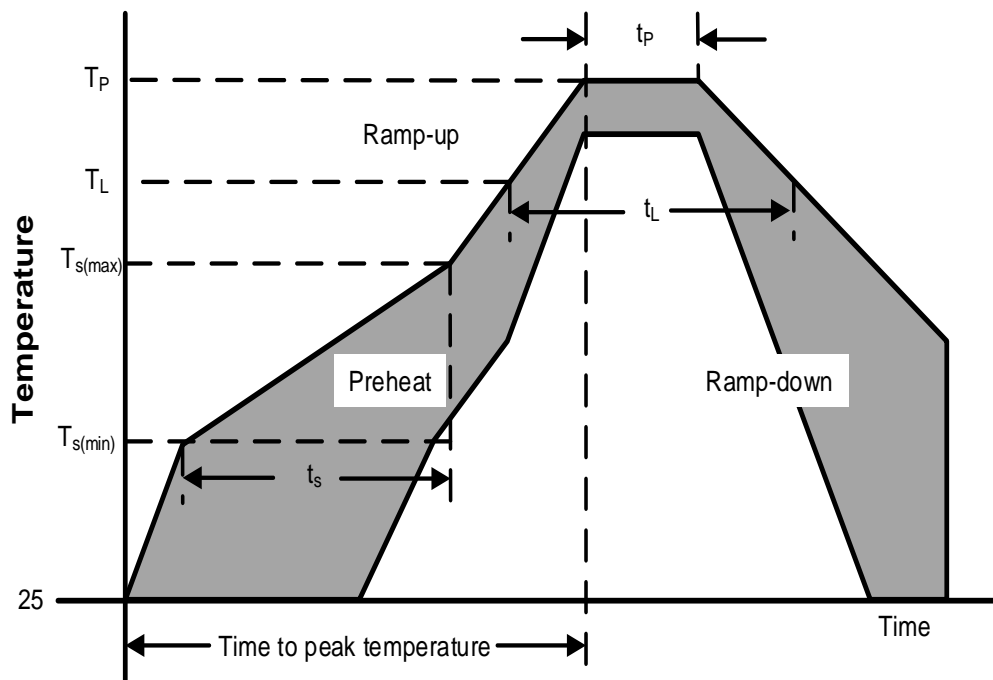

Figure 6: TLP Curve



Soldering Parameters

Reflow Condition		Pb – Free assembly
Pre Heat	Temperature Min ( $T_{s(min)}$ )	150°C
	Temperature Max ( $T_{s(max)}$ )	200°C
	Time (min to max) ( $t_s$ )	60 – 190 secs
Average ramp up rate (Liquidus Temp) ( $T_L$ ) to peak		5°C/second max
$T_{s(max)}$ to $T_L$ —Ramp-up Rate		5°C/second max
Reflow	Temperature ( $T_L$ ) (Liquidus)	217°C
	Temperature ( $t_L$ )	60 – 150 seconds
Peak Temperature ( $T_P$ )		260+0/-5 °C
Time within actual peak Temperature ( $t_p$ )		20 – 40 seconds
Ramp-down Rate		5°C/second max
Time 25°C to peak Temperature ( $T_P$ )		8 minutes Max.
Do not exceed		280°C



**Tape And Reel Information**

**Reel Dimensions**

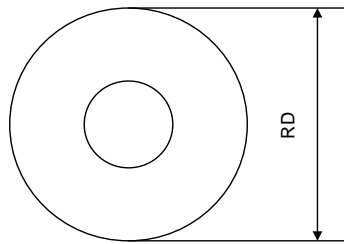

**Tape Dimensions**

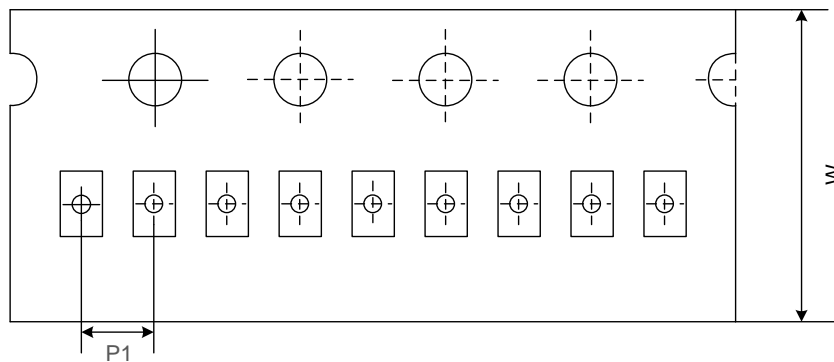

**Quadrant Assignments For PIN1 Orientation In Tape**

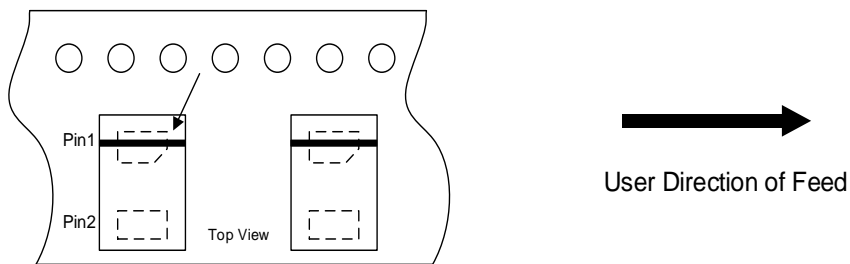

RD	Reel Dimensions	7 inch
W	Overall width of the carrier tape	8 mm
P1	Pitch between successive cavity centers	2mm

Outline Drawing –DFN1006-2L

**PACKAGE OUTLINE**

TOP VIEW

BOTTOM VIEW

SIDE VIEW

**DFN1006-2L**

SYMBOL	MILLIMETERS		
	MIN	NOM	MAX
A	0.350	-	0.400
A1	-	-	0.050
b	0.430	0.480	0.530
D	0.990	1.000	1.050
e	0.650BSC		
E	0.590	0.620	0.650
L	0.170	0.220	0.270
L1	0.075REF		
L2	0.070REF		
h	0.075	0.125	0.175

**Land Pattern**

**Marking Codes**

Part Number	Marking Code
WS5.5DFVH	<div style="display: flex; align-items: center; justify-content: center;"> <span style="margin-right: 5px;">1</span> <span style="margin-left: 5px;">2</span> </div> <p style="font-size: small;">K=Specific Device Code XX=Date Code</p>

**Package Information**

Qty: 10k/Reel

**CONTACT INFORMATION**

No.1001, Shiwan (7) Road, Pudong District, Shanghai, P.R.China.201207

Tel: 86-21-68969993 Fax: 86-21-50757680 Email: [market@way-on.com](mailto:market@way-on.com)

WAYON website: <http://www.way-on.com>

For additional information, please contact your local Sales Representative.

**WAYON** ® is registered trademark of WAYON Corporation.

Specifications are subject to change without notice.  
The device characteristics and parameters in this data sheet can and do vary in different applications and actual device performance may vary over time.  
Users should verify actual device performance in their specific applications.

单击下面可查看定价，库存，交付和生命周期等信息

[>>WAY-ON\(维安\)](#)