

PNP Silicon Transistor

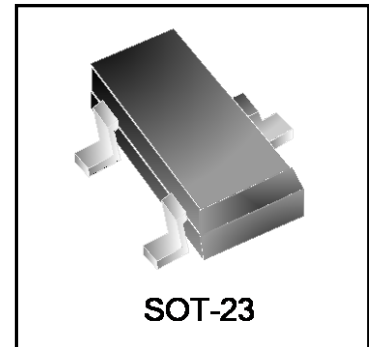

Features

- For General AF Applications
- High Collector Current
- High Current Gain
- Complementary Types: WT817 (NPN)

Mechanical Characteristics

- SOT-23 Package
- Marking : Making Code
- RoHS Compliant

Schematic & PIN Configuration

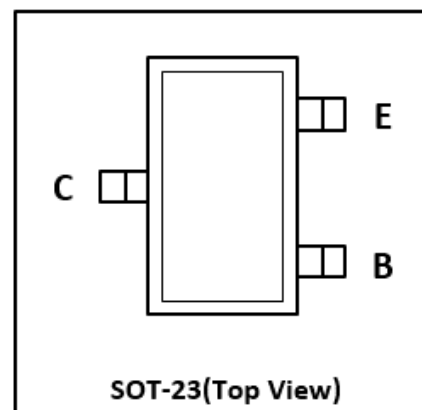
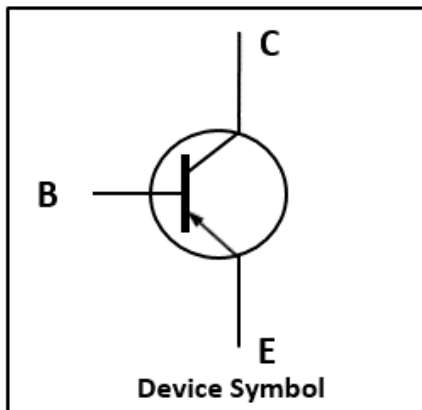

Absolute Maximum Rating

Parameter	Symbol	Value	Unit
Collector Base Voltage	V_{CBO}	-50	V
Collector Emitter Voltage	V_{CEO}	-45	V
Emitter Base Voltage	V_{EBO}	-5	V
Collector Current(DC)	I_C	-500	mA
Collector Power Dissipation ¹	P_C	300	mW
Junction Temperature	T_J	150	°C
Storage Temperature	T_{stg}	-55 ~ 150	°C
Thermal Resistance From Junction to Ambient ¹	$R_{\theta JA}$	417	°C/W

Electrical Characteristics ($T_{amb}=25^{\circ}C$ unless otherwise noted)

Parameter	Symbol	Test Conditions	Min.	Typ.	Max.	Unit
Collector-Base Breakdown Voltage	$V_{(BR)CBO}$	$I_C = -10\mu A, I_E = 0$	-50	-	-	V
Collector-Emitter Breakdown Voltage	$V_{(BR)CEO}$	$I_C = -10mA, I_B = 0$	-45	-	-	V
Emitter-Base Breakdown Voltage	$V_{(BR)EBO}$	$I_E = -1\mu A, I_C = 0$	-5	-	-	V
Collector Cut-off Current	I_{CBO}	$V_{CB} = -45V, I_E = 0$	-	-	-100	nA
Collector Cut-off Current	I_{CEO}	$V_{CE} = -40V, I_E = 0$	-	-	-200	nA
Emitter Cut-off Current	I_{EBO}	$V_{EB} = -4V, I_C = 0$	-	-	-100	nA
DC Current Gain	$h_{FE(1)}$	$V_{CE} = -1V, I_C = -100mA$	160	-	400	-
	$h_{FE(2)}$	$V_{CE} = -1V, I_C = -500mA$	40	-	-	-
Collector-Emitter Saturation Voltage	$V_{CE(sat)}$	$I_C = -500mA, I_B = -50mA$	-	-	-0.7	V
Base-Emitter Saturation Voltage	$V_{BE(sat)}$	$I_C = -500mA, I_B = -50mA$	-	-	-1.2	V
Transition Frequency	f_T	$V_{CE} = -5V, I_C = -10mA, f = 100MHz$	100	-	-	MHz

Notes

1. Transistor mounted on an FR4 printed-circuit board.
2. Pulse test: $t_p \leq 300 \mu s$; $\delta \leq 0.02$.
3. V_{BE} decreases by approx. 2mV/K with increasing temperature.

Typical Characteristics

Figure 1. Static Characteristics

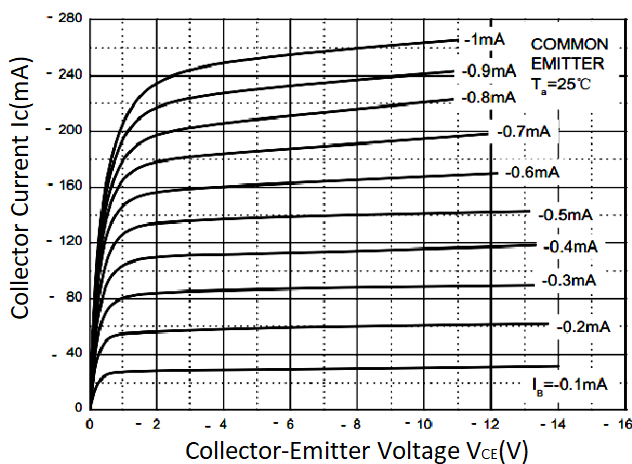

Figure 2. h_{FE} vs. I_C

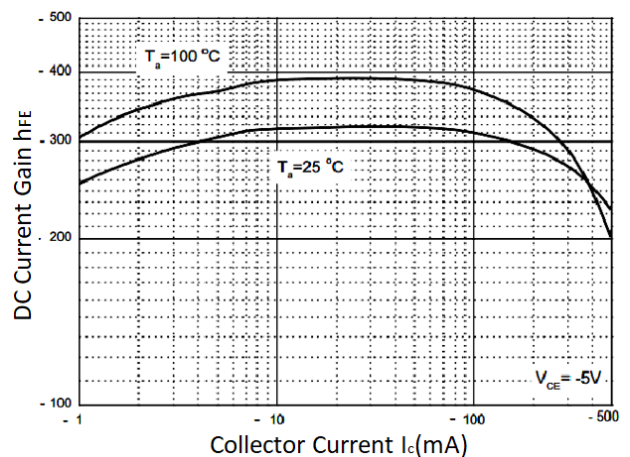

Figure 3. $V_{BE(sat)}$ vs. I_c

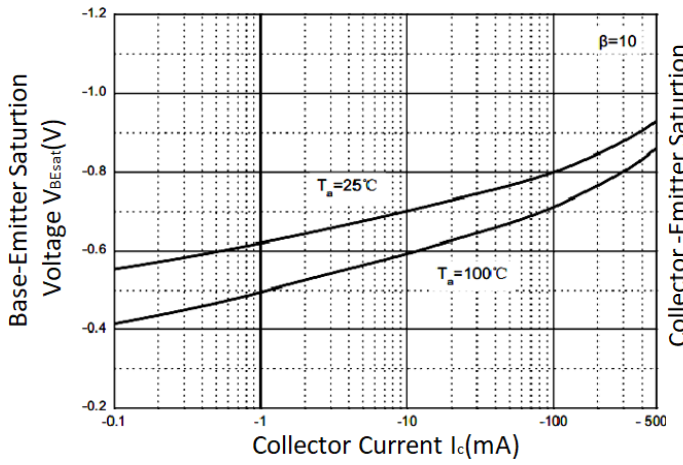

Figure 4. $V_{CE(sat)}$ vs. I_c

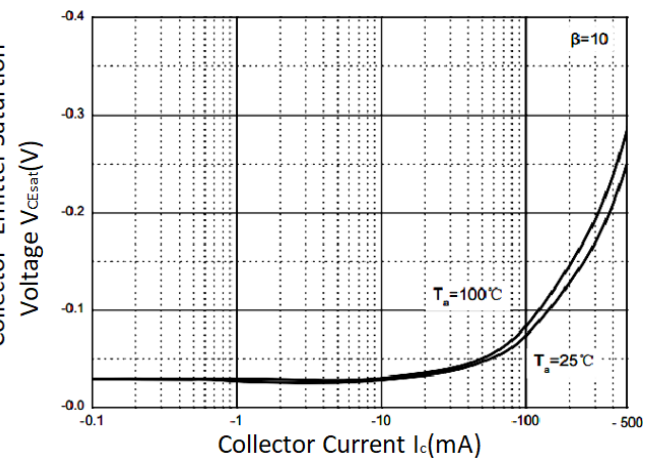

Figure 5. I_c vs. V_{BE}

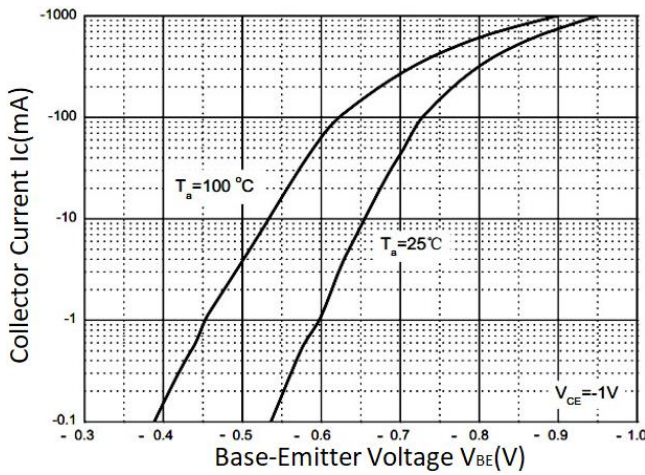

Figure 6. f_T vs. I_c

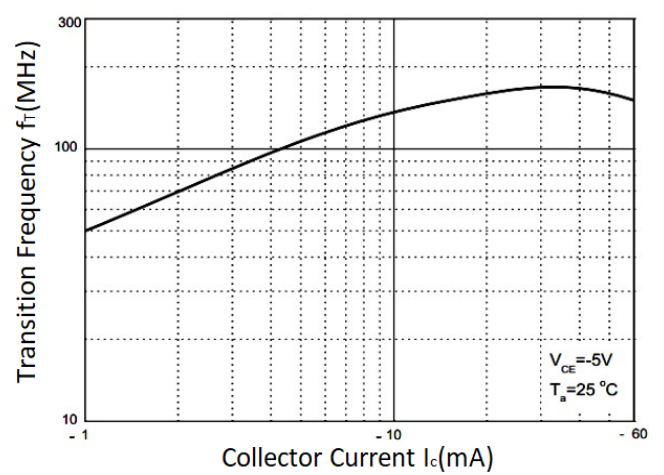

Figure 7. C_{ob} / C_{ib} vs. V_{CB} / V_{EB}

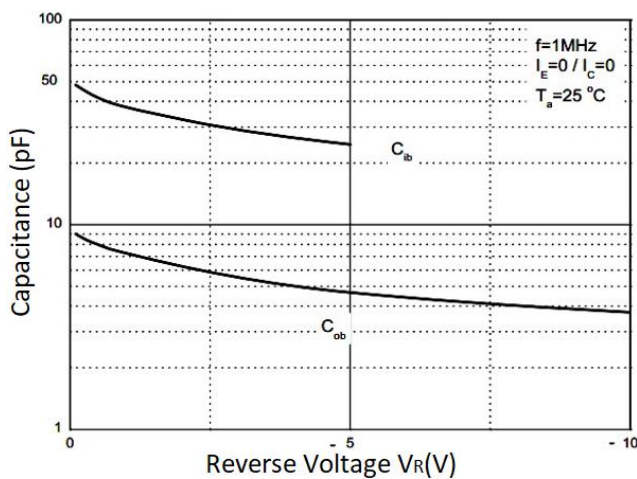
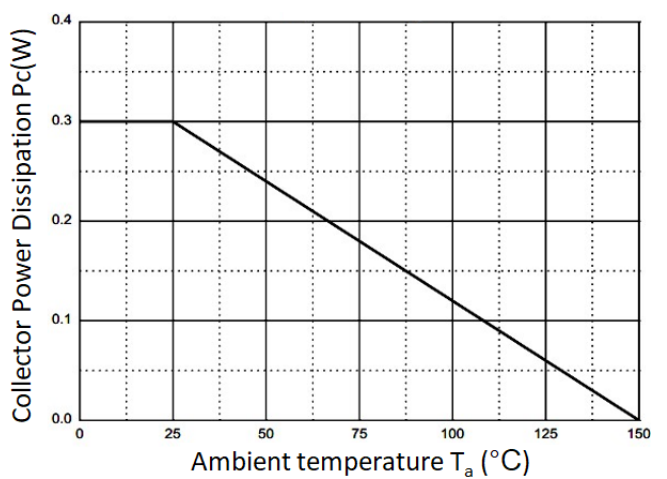

Figure 8. P_c vs. T_a



Outline Drawing – SOT-23

PACKAGE OUTLINE

SOT-23

SYMBOL	MILLIMETER		INCHES	
	MIN	MAX	MIN	MAX
A	0.90	1.15	0.035	0.045
A1	0.00	0.10	0.000	0.004
b	0.30	0.50	0.012	0.020
c	0.08	0.15	0.003	0.006
D	2.80	3.00	0.110	0.118
E	2.25	2.55	0.089	0.100
E1	1.20	1.40	0.047	0.055
e	0.95 BSC		0.0374 BSC	
e1	1.80	2.00	0.071	0.079
L	0.45	0.65	0.018	0.026
θ	0	8°	0	8°

DIMENSIONS		
DIM	INCHES	MILLIMETERS
M	0.080	2.02
C	0.032	0.80
Z	0.111	2.82
e	0.037 BSC	0.95 BSC
e1	0.075 BSC	1.90 BSC
b	0.032	0.80

Notes

1. Dimensioning and tolerances per ANSI Y14.5M, 1985.
2. Controlling Dimension: Inches
3. Pin 3 is the cathode (Unidirectional Only).
4. Dimensions are exclusive of mold flash and metal burrs.

Marking Codes

Part Number	WT807
Marking Code	

Package Information

Qty: 3k/Reel

CONTACT INFORMATION

No.1001, Shiwan (7) Road, Pudong District, Shanghai, P.R.China.201207
 Tel: 86-21-68969993 Fax: 86-21-50757680 Email: market@way-on.com
 WAYON website: <http://www.way-on.com>
 For additional information, please contact your local Sales Representative.

WAYON ® is registered trademark of Wayon Corporation.

Specifications are subject to change without notice.
 The device characteristics and parameters in this data sheet can and do vary in different applications and actual device performance may vary over time.
 Users should verify actual device performance in their specific applications.

单击下面可查看定价，库存，交付和生命周期等信息

[>>WAY-ON\(维安\)](#)