

## Low Loss Adjustable Current Limited Load Switch

### General Description

The WP25P041T5-B is current limited P-channel MOSFET power switch designed for high-side load switching applications. This switch operates with inputs ranging from 2.5V to 5.2V, making it ideal for both 3.3V and 5V systems. An integrated current-limiting circuit protects the input supply against large currents which may cause the supply to fall out of regulation. The WP25P041T5-B is also protected from thermal overload which limits power dissipation and junction temperatures. It can be used to control load that requires from 75mA to 400mA. Current limit threshold is programmed with a resistor from SET to ground. The quiescent supply current in active mode is only 100µA. In shutdown mode, the supply current decreases to less than 1µA. The device has an output over-voltage protection, when this condition stays on for longer than 15µs, the output is disabled and shut down.

The WP25P041T5-B is available in Pb-free packages and is specified over the -40°C to +85°C

ambient temperature range.

### Features

- Input Voltage Range: 2.5V to 5.2V
- Programmable Current Limit (75mA to 400mA)
- Reverse Current Blocking
- Low Quiescent Current: 100µA (Typ)
- 1µA Max Shutdown Supply Current
- 15µs Short Circuit Response Typically
- Built-in Pull-up Resistor for EN Pin
- Output Over-voltage Protection
- Automatic Output Discharge at Shutdown
- Under-Voltage Lockout
- Thermal Shutdown
- 2kV ESD Rating
- Ambient Temperature Range: -40°C to +85°C

### Applications

- Laptop/Desktop Computers and Netbooks
- Smart Phones, e-Readers
- LCD TVs and Monitors
- Set-Top-Boxes, Residential Gateways
- Printers, Docking Stations, HUBs

### Typical Application

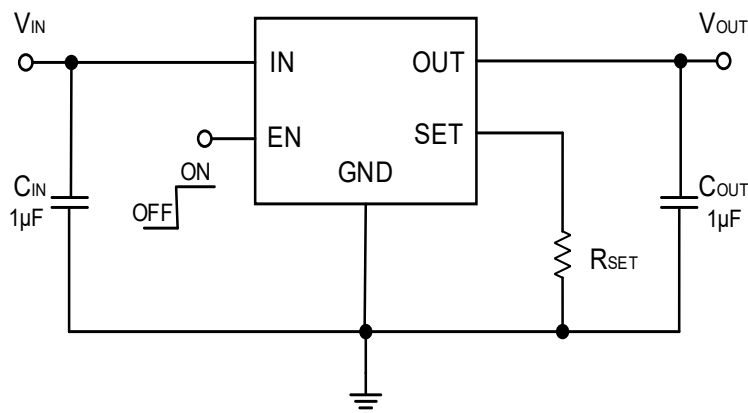

Note: Tantalum or Aluminum Electrolytic capacitors ( $C_{IN}$  and  $C_{OUT}$ ) may be required for USB applications

## Pin Configuration

(Top View)

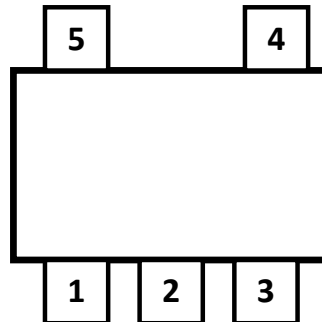

## Pin Description

Pin Number	Pin Name	Pin Function
1	OUT	Power output.
2	GND	Ground pin.
3	SET	Current limit programming pin, with a resistor from ISET to ground.
4	EN	Enable input, High enable.
5	IN	Power supply input.

## Absolute Maximum Ratings

Parameter	Rating	Unit
IN, EN, SET Voltage	-0.3 to 6	V
OUT Voltage	-0.3 to $V_{IN} + 0.3$	V
OUT Current	ADJ	A
Power Dissipation	400	mW
Package Thermal Resistance( $\theta_{JA}$ )	250	$^{\circ}\text{C}/\text{W}$
Operating Junction Temperature	-40 to 125	$^{\circ}\text{C}$
Storage Temperature	-55 to 150	$^{\circ}\text{C}$
Lead Temperature (Soldering, 10 sec)	300	$^{\circ}\text{C}$

**Electrical Characteristics** ( $V_{IN}=+5.0V$ ,  $T_A=25^{\circ}C$ , unless otherwise specified.)

Symbol	Parameter	Test Conditions	Min	Typ.	Max	Unit
$V_{IN}$	Input Voltage Range		2.5		5.2	V
$I_{SHDN}$	Shutdown Input Current	Disabled, OUT floating or shorted to ground		0.3	1	$\mu A$
$I_Q$	Quiescent Supply Current	Enabled, $I_{OUT} = 0A$		100	140	$\mu A$
$R_{DS(ON)}$	Switch on-resistance	$V_{IN} = 5V$ , $I_{OUT} = 0.2A$	100	250	350	m $\Omega$
$I_{LMT}$	Current Limit	$V_{IN} = 5V$ , $V_{OUT} = 4.5V$ , $R_{SET}=12.7k\Omega$	320	400	480	mA
		$V_{IN} = 5V$ , $V_{OUT} = 4.5V$ , $R_{SET}=16.9k\Omega$	240	300	360	mA
		$V_{IN} = 5V$ , $V_{OUT} = 4.5V$ , $R_{SET}=24.9k\Omega$	150	200	250	mA
		$V_{IN} = 5V$ , $V_{OUT} = 4.5V$ , $R_{SET}=64.9k\Omega$	55	75	95	mA
		$V_{IN} = 5V$ , $V_{OUT} = 4.5V$ , open $R_{SET}$	320	400	480	mA
	Current Limit (short circuit)	$V_{IN} = 5V$ , $V_{OUT} = 0V$ , $R_{SET}=12.7k\Omega$	295	430	465	mA
		$V_{IN} = 5V$ , $V_{OUT} = 0V$ , $R_{SET}=16.9k\Omega$	208	270	332	mA
		$V_{IN} = 5V$ , $V_{OUT} = 0V$ , $R_{SET}=24.9k\Omega$	115	170	225	mA
		$V_{IN} = 5V$ , $V_{OUT} = 0V$ , $R_{SET}=64.9k\Omega$	18	40	62	mA
		$V_{IN} = 5V$ , $V_{OUT} = 0V$ , open $R_{SET}$	310	400	490	mA
$V_{IL}$	EN Input Logic Low Voltage	Note 1			0.5	V
$V_{IH}$	EN Input Logic High Voltage	Note 1	1.5			V
$I_{SINK}$	EN Input leakage	$V_{EN} = 5V$		0.01	1	$\mu A$
		$V_{EN} = 0V$	-2	-0.25		$\mu A$
$V_{UVLO}$	Input UVLO Threshold		1.4	1.8	2.2	V
$V_{UVLOHys}$	Input UVLO Hysteresis			0.1		V
$I_{REV}$	Reverse Leakage Current	$V_{IN} = 0V$ , $V_{OUT} = 5V$ , $I_{REV}$ at $V_{IN}$		0.01	0.1	$\mu A$
$I_{ROCP}$	Reverse-Current Trigger Point	$V_{IN} = 5.0V$ , $V_{OUT} = 5.2V$		0.2	0.25	A
$T_{TRIG}$	Deglitch time from reverse current trigger to MOSFET turn off	Note 2	0.5	0.7	1.0	ms
$V_{OVP}$	Output over-voltage trip point	Note 3	5.3		5.6	V
$R_{DIS}$	OUT Shutdown Discharge Resistance			400		$\Omega$
$T_{SHDN}$	Thermal Shutdown Temperature	$V_{IN} = 5V$		150		$^{\circ}C$

# WP25P041T5-B



Symbol	Parameter	Test Conditions	Min	Typ.	Max	Unit
T <sub>HYS</sub>	Thermal Shutdown Hysteresis	V <sub>IN</sub> = 5V		20		°C
T <sub>R</sub>	Output turn-on rise time	V <sub>IN</sub> =5V, C <sub>L</sub> =1μF, R <sub>L</sub> =20Ω		0.5		ms
ESD HBM	Human Body Model ESD Protection			2000		V

Note 1: When EN pin is floating, the chip is enabled.

Note 2: When reverse current triggers at I<sub>ROCP</sub> = 0.20A, the reverse current is continuously clamped at I<sub>ROCP</sub> for 0.7ms deglitch time until MOSFET is turned off.

Note 3: During output over-voltage protection, the output draws approximately 60μA current.

### Typical Performance Characteristics

(TA=25°C, unless otherwise noted)

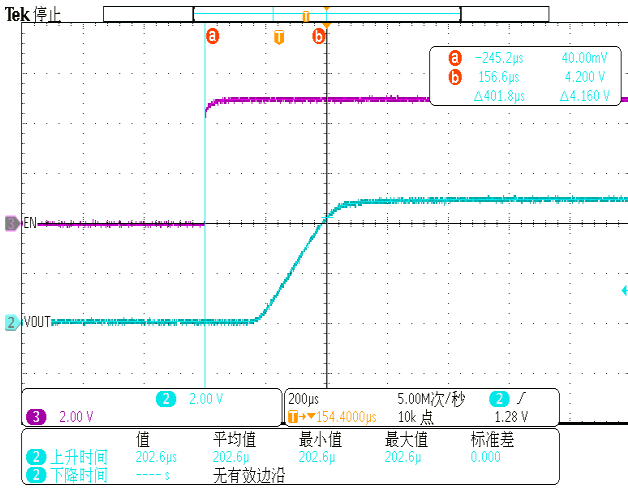

Turn On Response

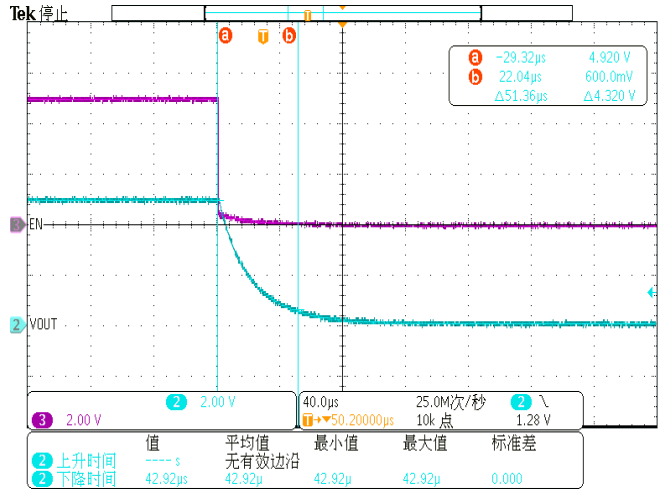

Turn Off Response

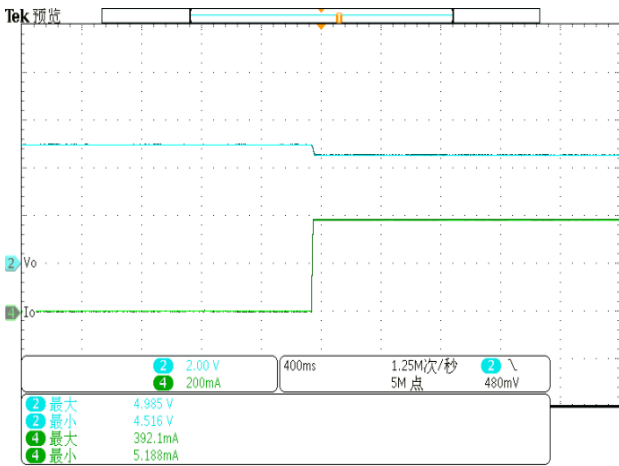

Overload Current-limit (open R<sub>SET</sub>)

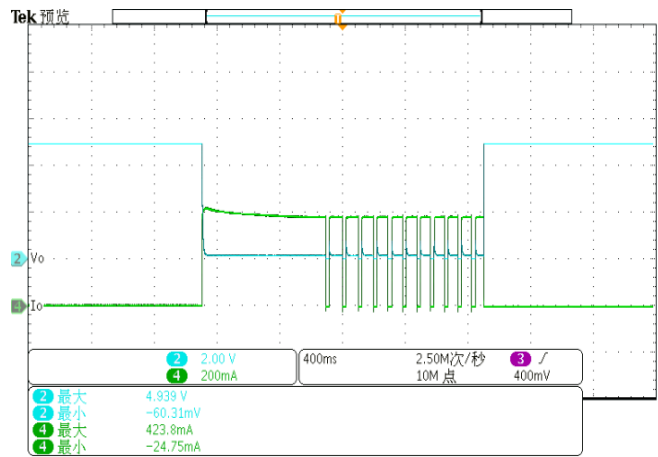

Short Current Response & Thermal Shutdown

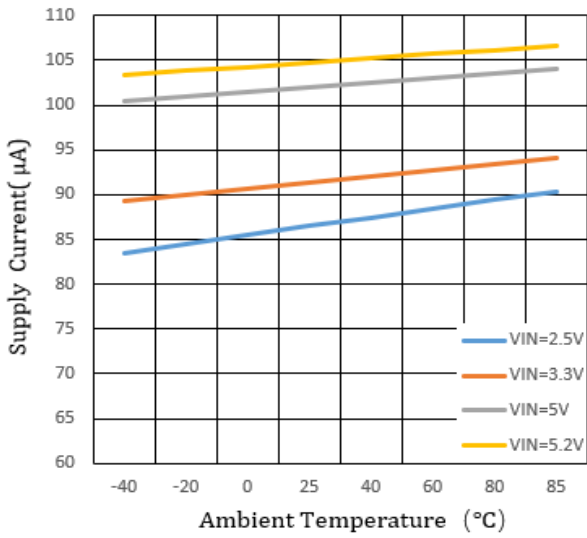

Quiescent Supply Current vs. Ambient Temperature

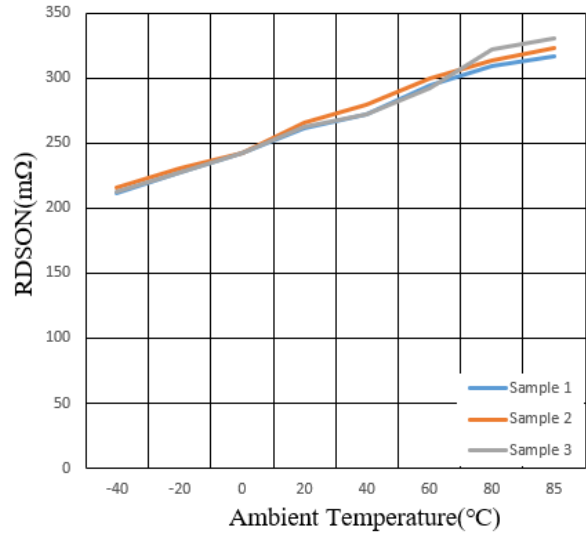

Switch On-Resistance vs. Ambient Temperature

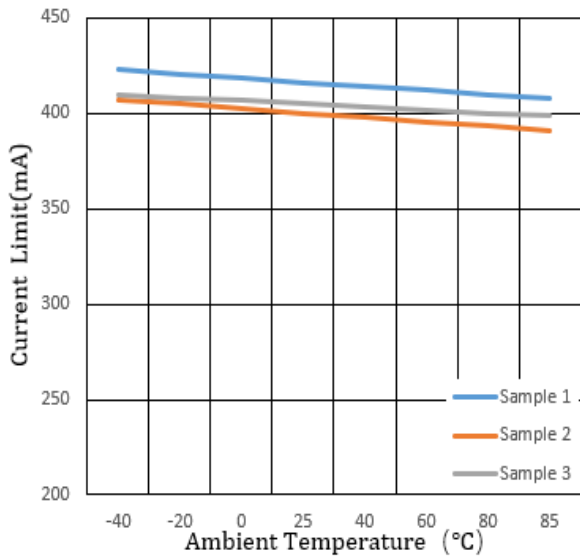

Current-Limit Threshold vs. Ambient Temperature (open R<sub>SET</sub>)

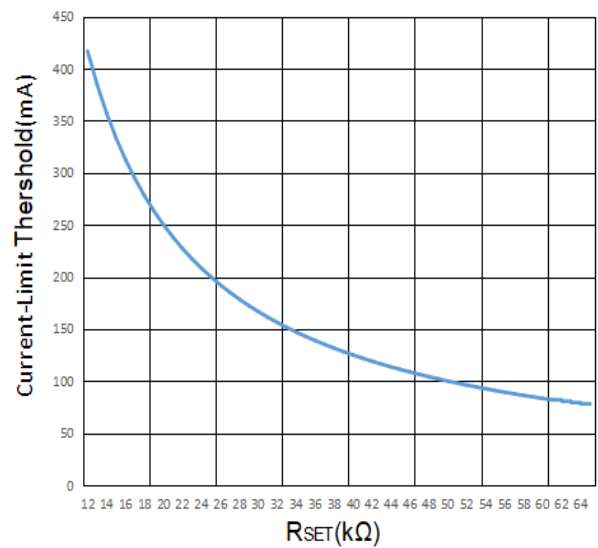

Current-Limit Threshold vs. R<sub>SET</sub>

## Operation

WP25P041T5-B is an integrated power switch with a low  $R_{DS(ON)}$  P-channel MOSFET, internal gate drive circuit. When the WP25P041T5-B turns on, it can deliver up to 250mA continuous current to load. When the device is active, if there is no load, the device only consumes 100µA supply current, which makes the device suitable for battery powered applications.

## Power Supply Considerations

A 0.1µF to 1µF ceramic bypass capacitor between IN and GND, close to the device, is recommended. Placing a high-value electrolytic capacitor on the output pin is recommended when the output load is heavy. This precaution reduces power-supply transients that may cause ringing on the input and minimize the input voltage droops. Additionally, bypassing the output with a 0.1µF to 1µF ceramic capacitor improves the immunity of the device to short-circuit transients.

## Power Dissipation and Junction Temperature

The low on-resistance on the P-channel MOSFET allows the small surface-mount packages to pass large currents. It is good design practice to check power dissipation and junction temperature for each application. Begin by determining the  $R_{DS(ON)}$  of the P-channel MOSFET relative to the input voltage and operating temperature. Using the highest operating ambient temperature of interest and  $R_{DS(ON)}$ , the power dissipation per switch can be calculated by:

$$P_D = R_{DS(ON)} \times I^2$$

Finally, calculate the junction temperature:

$$T_J = P_D \times R_{\theta JA} + T_A$$

Where:

$T_A$  = Ambient temperature

$R_{\theta JA}$  = Thermal resistance

$P_D$  = Total power dissipation

Compare the calculated junction temperature with the maximum junction temperature which is 125°C. If they are within degrees, either the maximum load current needs to be

reduced or another package option will be required.

## Over Current

A sense FET is employed to check for overcurrent conditions. When an overcurrent condition is detected, the device maintains a constant output current and reduces the output voltage accordingly. WP25P041T5-B will limit the current until the overload condition is removed or the device begins to thermal cycle.

Three possible overload conditions can occur. In the first condition, the output has been shorted before the device is enabled or before  $V_{IN}$  has been applied. The WP25P041T5-B senses the short and immediately switches into a constant-current output.

In the second condition, a short or an overload occurs while the device is enabled. At the instant the overload occurs, high currents may flow for a short period of time before the current-limit circuit can react. After the current-limit circuit reached the over current trip threshold, the device switches into constant-current mode.

In the third condition, the load has been gradually increased beyond the recommended operating current. The current is permitted to rise until the current-limit threshold is reached or until the thermal limit of the device is exceeded. The WP25P041T5-B is capable of delivering current up to the current-limit threshold without damaging the device. Once the threshold has been reached, the device switches into its constant-current mode.

## Thermal Protection

Thermal protection prevents damage to the IC when heavy-overload or short-circuit faults are present for extended periods of time. The WP25P041T5-B implements a thermal sensing to monitor the operating junction temperature of the power distribution switch. In an over current or short-circuit condition, the junction temperature rises due to excessive power dissipation. Once the die temperature rises to approximately 150° C due to over current conditions, the internal thermal sense circuitry turns the power switch off,

# WP25P041T5-B

---

thus preventing the power switch from damage. Hysteresis is built into the thermal sense circuit, and after the device has cooled approximately 20° C, the switch turns back on. The switch continues to cycle in this manner until the load fault or input power is removed.

## Reverse-Current Protection

In some applications, such as USB port. The USB specification does not allow an output device to source current back into the USB port. A reverse current limit feature is implemented in the WP25P041T5-B to limit such back currents. Reverse current limit is always active in WP25P041T5-B. The reverse current is limited to half of the constant-current and when the fault exists for more than 700µs, output device is disabled and shut down. This is called the “Debounce time from reverse current trigger to MOSFET turn off”.

## Over-Voltage Protection

The device has an output over-voltage protection that triggers when the output voltage reaches 5.3V (MIN). When this fault condition stays on for longer than 15µs, (This is called the “Debounce time from output over voltage to MOSFET turn off”) output device is disabled and shut down.

## Current Limiting Setting

Current limit is programmable to protect the power source from over current and short circuit conditions. Connect the closest 1% resistor  $R_{SET}$  from SET pin to GND to program the current limit:

$$I_{LIM(A)} = 5000 / R_{SET} (\Omega)$$

The minimum current limit is 75mA. Current limit beyond 400mA is not recommended.

When  $R_{SET} = \infty$  (SET Pin is floating), the current limit is 320mA ~ 480mA.

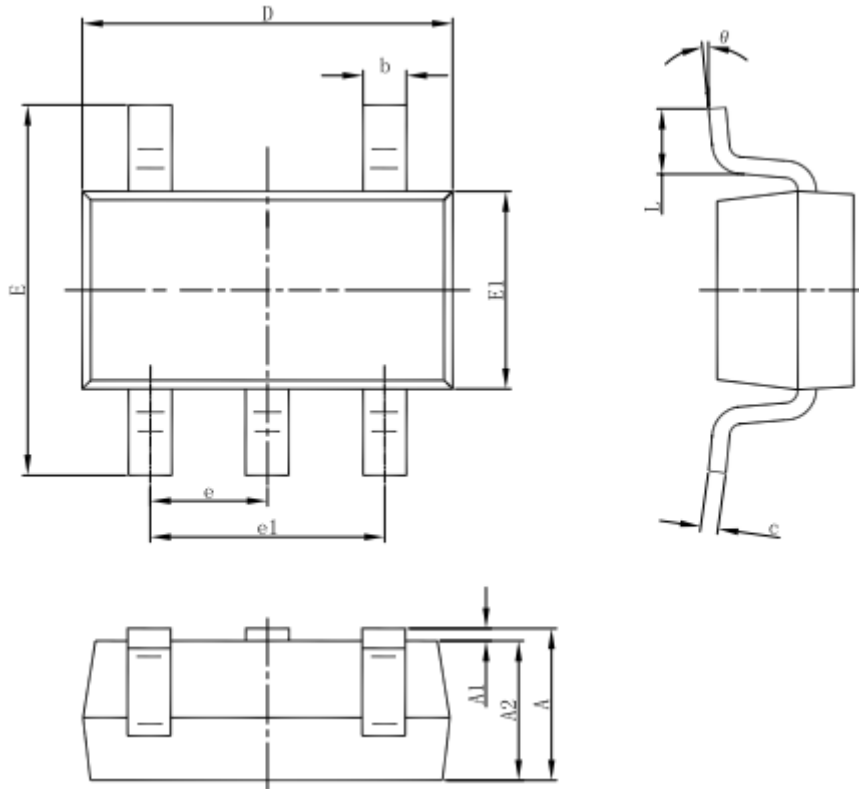

**Package Information**

**SOT23-5**

SYMBOL	DIMENSIONS IN MILLIMETERS	
	MIN	MAX
<b>A</b>	1.000	1.350
<b>A1</b>	0.000	0.150
<b>A2</b>	1.000	1.200
<b>b</b>	0.300	0.500
<b>c</b>	0.100	0.200
<b>D</b>	2.820	3.020
<b>E1</b>	1.500	1.700
<b>E</b>	2.600	3.000
<b>e</b>	0.950(BSC)	
<b>e1</b>	1.800	2.000
<b>L</b>	0.300	0.600
<b>θ</b>	0°	8°

# WP25P041T5-B

## Ordering Information

Part Number	Current Limit	Package	Packing Quantity	Marking*
WP25P041T5-B	ADJ	SOT23-5	3k/Reel	5P041 BXXXX

\*XXXX is variable.

## Contact Information

No.1001, Shiwan(7) Road, Pudong District, Shanghai, P.R.China.201202

Tel: 86-21-68960674 Fax: 86-21-50757680 Email: market@way-on.com

WAYON website: <http://www.way-on.com>

For additional information, please contact your local Sales Representative.

 is registered trademark of Wayon Corporation.

*Specifications are subject to change without notice.*

*The device characteristics and parameters in this data sheet can and do vary in different applications and actual device performance may vary over time.*

*Users should verify actual device performance in their specific applications.*

单击下面可查看定价，库存，交付和生命周期等信息

[>>WAY-ON\(维安\)](#)