

General Description

The WSF45P10 is the highest performance trench P-Ch MOSFET with extreme high cell density, which provide excellent $R_{DS(ON)}$ and gate charge for most of the small power switching and load switch applications.

The WSF45P10 meet the RoHS and Green Product requirement with full function reliability approved.

Features

- Advanced high cell density Trench technology
- Super Low Gate Charge
- Excellent Cdv/dt effect decline
- Green Device Available

Product Summary

BV_{DSS}	$R_{DS(ON)}$	I_D
-100V	44m Ω	-40A

Applications

- Inverters

TO-252 Pin Configuration

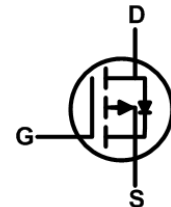
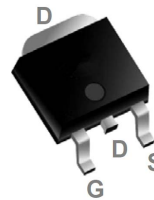

Absolute Maximum Ratings

Symbol	Parameter	Rating	Unit
Common Ratings ($T_C=25^\circ\text{C}$ Unless Otherwise Noted)			
V_{DSS}	Drain-Source Voltage	-100	V
V_{GSS}	Gate-Source Voltage	± 20	
T_J	Maximum Junction Temperature	175	$^\circ\text{C}$
T_{STG}	Storage Temperature Range	-55 to 175	$^\circ\text{C}$
I_S	Diode Continuous Forward Current	$T_C=25^\circ\text{C}$ -40	A
Mounted on Large Heat Sink			
I_{DM}	Pulsed Drain Current *	-120**	A
I_D	Continuous Drain Current	$T_C=25^\circ\text{C}$ -40	A
		$T_C=100^\circ\text{C}$ -26	
P_D	Maximum Power Dissipation	$T_C=25^\circ\text{C}$ 136	W
		$T_C=100^\circ\text{C}$ 68	
$R_{\theta JC}$	Thermal Resistance-Junction to Case	1.1	$^\circ\text{C}/\text{W}$
$R_{\theta JA}$	Thermal Resistance-Junction to Ambient	62.5	
Avalanche Ratings			
E_{AS}	Avalanche Energy, Single Pulsed	$L=0.5\text{mH}$ 308***	mJ

Note : * Repetitive rating ; pulse width limited by junction temperatur

** Drain current is limited by junction temperature

*** $V_D=-80\text{V}$

Electrical Characteristics ($T_C=25^\circ\text{C}$ Unless Otherwise Noted)

Symbol	Parameter	Test Conditions	Min.	Typ.	Max.	Unit
Static Characteristics						
BV_{DSS}	Drain-Source Breakdown Voltage	$V_{GS}=0V, I_{DS}=-250\mu A$	-100	-	-	V
I_{DSS}	Zero Gate Voltage Drain Current	$V_{DS}=-100V, V_{GS}=0V$ $T_J=85^\circ\text{C}$	-	-	-1	μA
$V_{GS(th)}$	Gate Threshold Voltage	$V_{DS}=V_{GS}, I_{DS}=-250\mu A$	-1	-2	-3	V
I_{GSS}	Gate Leakage Current	$V_{GS}=\pm 20V, V_{DS}=0V$	-	-	± 100	nA
$R_{DS(ON)}^*$	Drain-Source On-state Resistance	$V_{GS}=-10V, I_{DS}=-20A$	-	44	55	$m\Omega$
$R_{DS(ON)}^*$	Drain-Source On-state Resistance	$V_{GS}=-4.5V, I_{DS}=-20A$	-	47	58.5	$m\Omega$
Diode Characteristics						
V_{SD}^*	Diode Forward Voltage	$I_{SD}=-20A, V_{GS}=0V$	-	-0.8	-1.2	V
t_{rr}	Reverse Recovery Time	$I_{SD}=-20A, dI_{SD}/dt=-100A/\mu s$	-	70	-	ns
Q_{rr}	Reverse Recovery Charge		-	90	-	nC
Dynamic Characteristics						
R_G	Gate Resistance	$V_{GS}=0V, V_{DS}=0V, F=1\text{MHz}$	-	2	-	Ω
C_{iss}	Input Capacitance	$V_{GS}=0V,$ $V_{DS}=-20V,$ Frequency=1.0MHz	-	5720	-	pF
C_{oss}	Output Capacitance		-	790	-	
C_{riss}	Reverse Transfer Capacitance		-	450	-	
$t_{d(ON)}$	Turn-on Delay Time	$V_{DD}=-50V, R_G=6\Omega,$ $I_{DS}=-20A, V_{GS}=-10V,$	-	30	-	ns
T_r	Turn-on Rise Time		-	79	-	
$t_{d(OFF)}$	Turn-off Delay Time		-	82	-	
T_f	Turn-off Fall Time		-	69	-	
Gate Charge Characteristics						
Q_g	Total Gate Charge	$V_{DS}=-80V, V_{GS}=-10V,$ $I_{DS}=-20A$	-	125	-	nC
Q_{gs}	Gate-Source Charge		-	21	-	
Q_{gd}	Gate-Drain Charge		-	45	-	

Note * : Pulse test ; pulse width $\leq 300\mu s$, duty cycle $\leq 2\%$.

Typical Characteristics

Output Characteristics

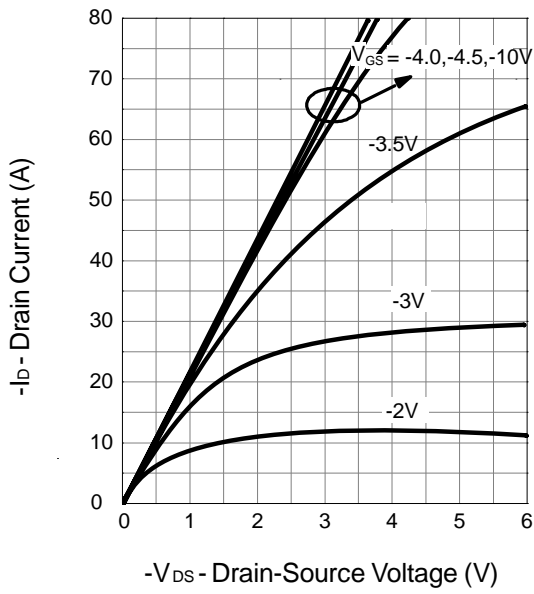

Drain-Source On Resistance

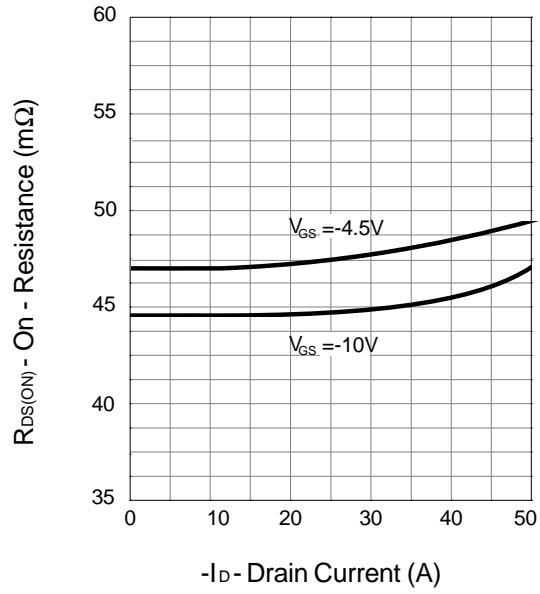

Drain-Source On Resistance

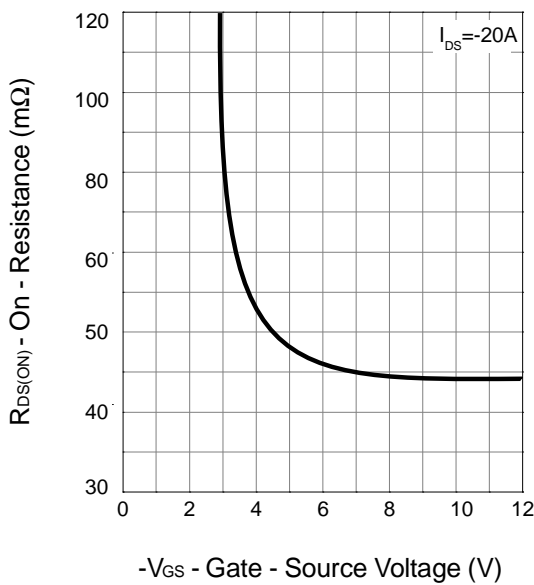

Gate Threshold Voltage

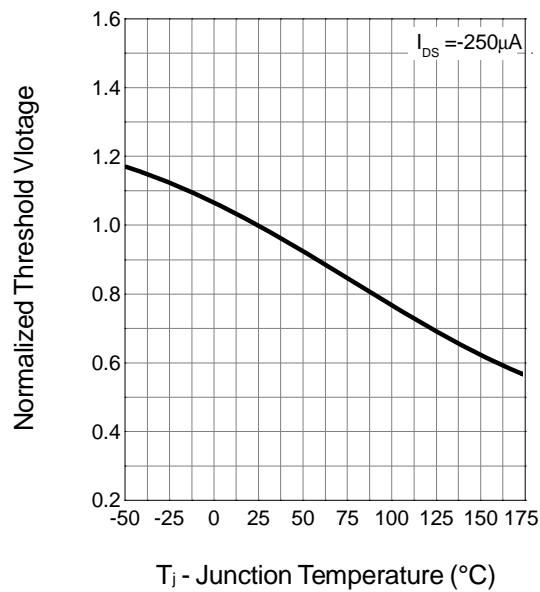

Typical Characteristics

Drain-Source On Resistance

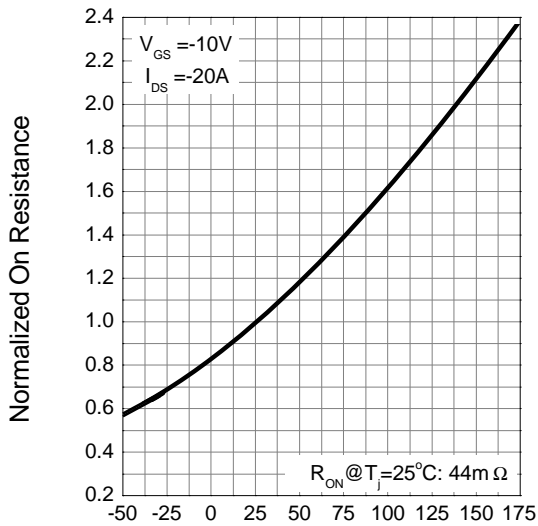

T_j - Junction Temperature (°C)

Source-Drain Diode Forward

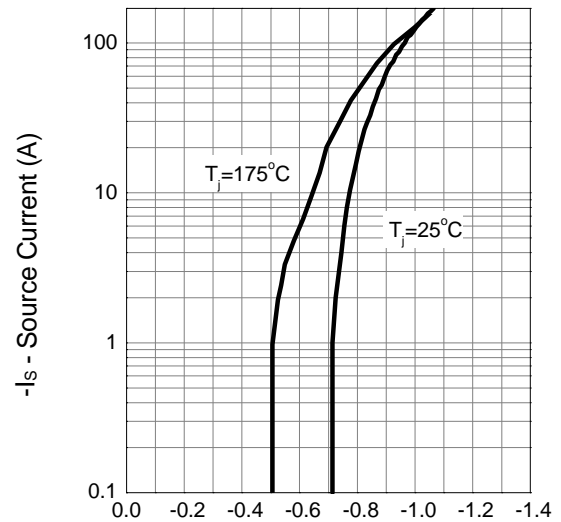

-V_{SD} - Source-Drain Voltage (V)

Capacitance

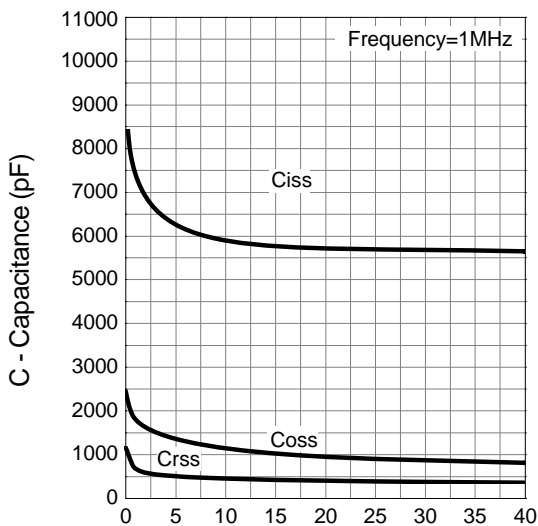

-V_{DS} - Drain - Source Voltage (V)

Gate Charge

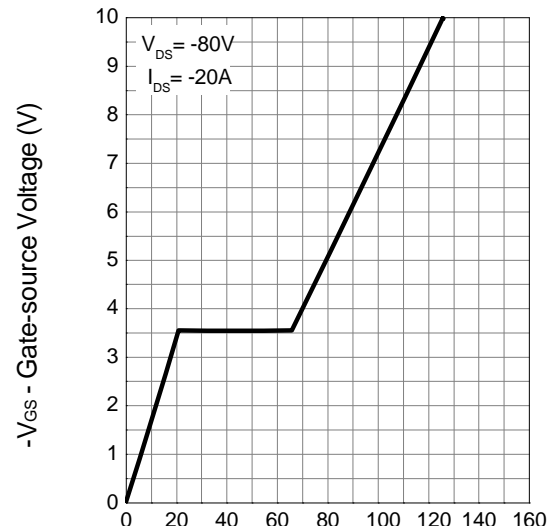

Q_G - Gate Charge (nC)

Typical Characteristics

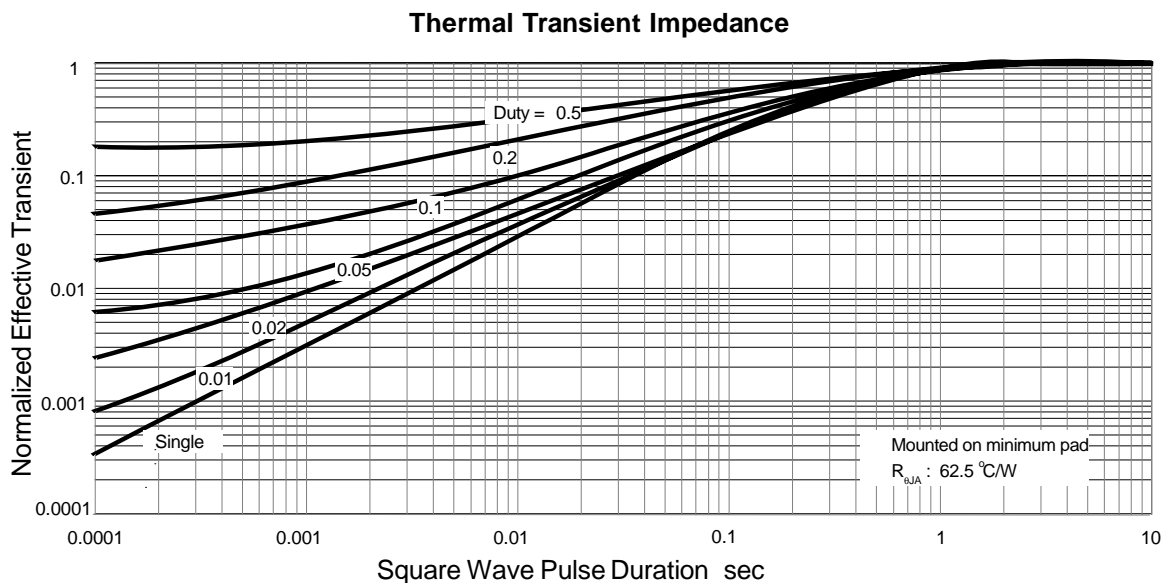
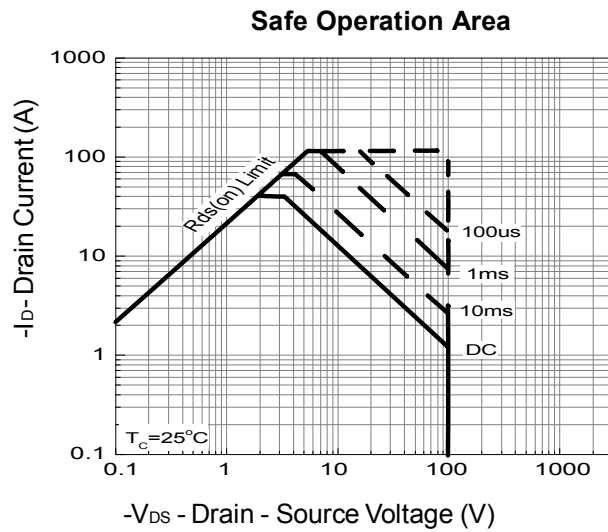
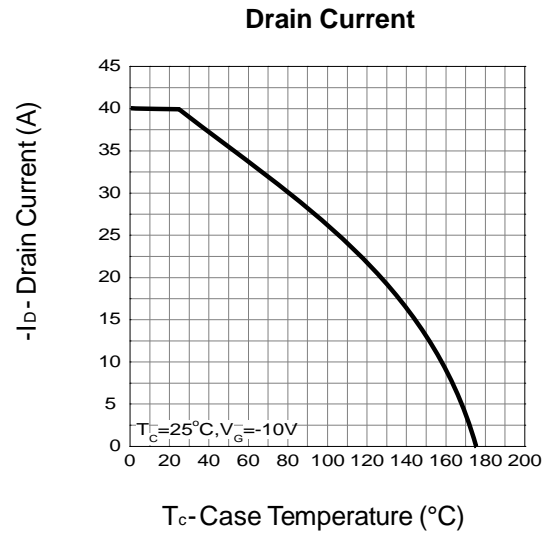
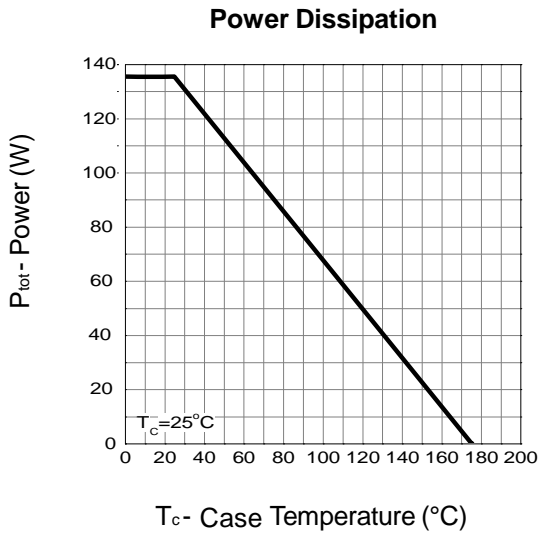

Package Information

TO-252

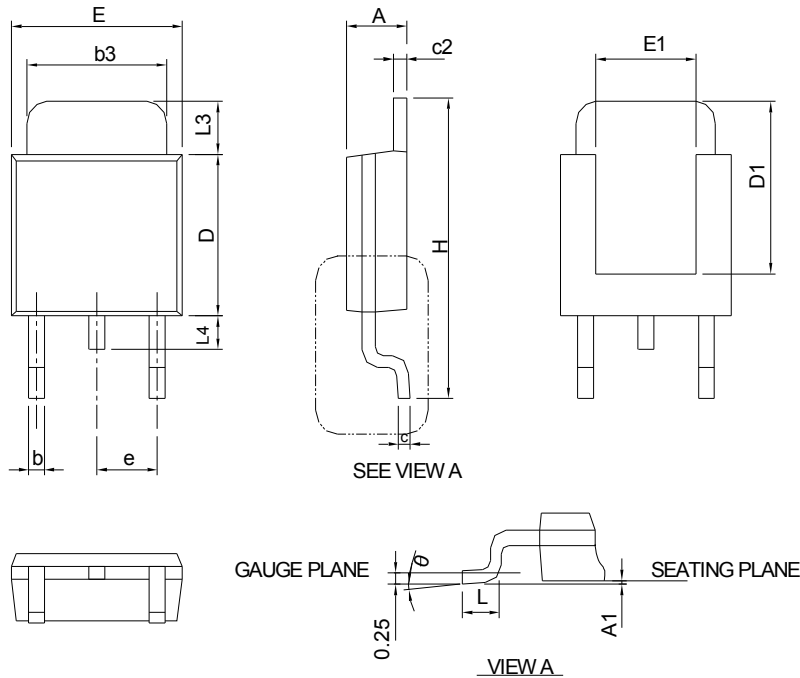

DIMENSIONS	TO-252			
	MILLIMETERS		INCHES	
	MIN.	MAX.	MIN.	MAX.
A	2.18	2.39	0.086	0.094
A1	-	0.13	-	0.005
b	0.50	0.89	0.020	0.035
b3	4.95	5.46	0.195	0.215
c	0.46	0.61	0.018	0.024
c2	0.46	0.89	0.018	0.035
D	5.33	6.22	0.210	0.245
D1	4.57	6.00	0.180	0.236
E	6.35	6.73	0.250	0.265
E1	3.81	6.00	0.150	0.236
e	2.29 BSC		0.090 BSC	
H	9.40	10.41	0.370	0.410
L	0.90	1.78	0.035	0.070
L3	0.89	2.03	0.035	0.080
L4	-	1.02	-	0.040
θ	0°	8°	0°	8°

RECOMMENDED LAND PATTERN

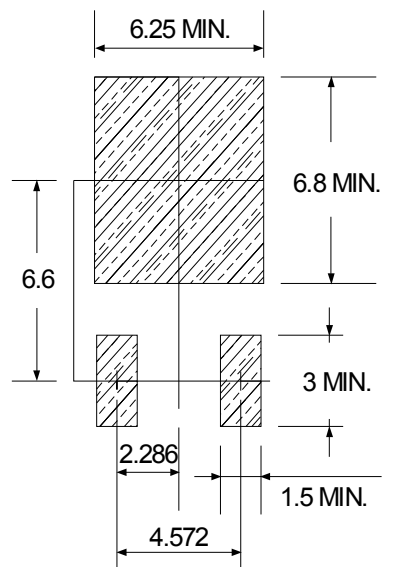

UNIT: mm

Note : Follow JEDEC TO-252 .

Classification Profile

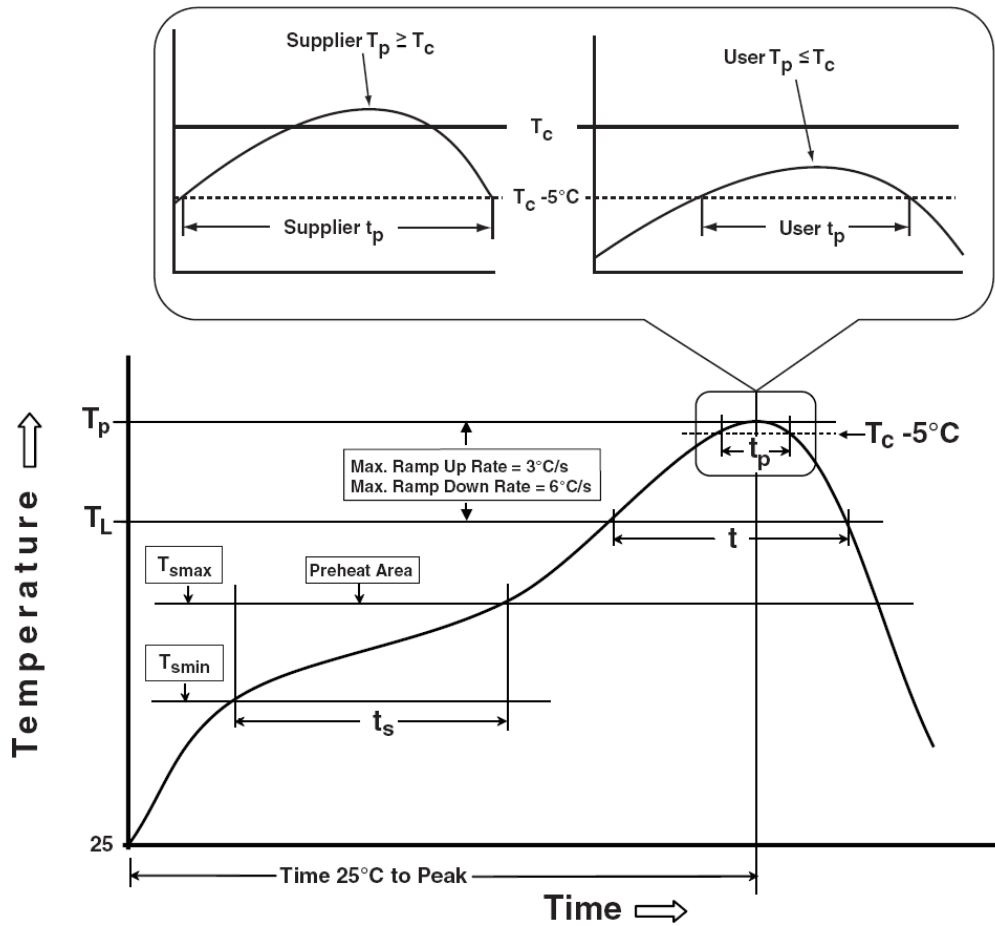

Classification Reflow Profiles

Profile Feature	Sn-Pb Eutectic Assembly	Pb-Free Assembly
Preheat & Soak		
Temperature min (T_{smin})	100 °C	150 °C
Temperature max (T_{smax})	150 °C	200 °C
Time (T_{smin} to T_{smax}) (t_s)	60-120 seconds	60-120 seconds
Average ramp-up rate (T_{smax} to T_p)	3 °C/second max.	3°C/second max.
Liquidous temperature (T_L)	183 °C	217 °C
Time at liquidous (t_L)	60-150 seconds	60-150 seconds
Peak package body Temperature (T_p)*	See Classification Temp in table 1	See Classification Temp in table 2
Time (t_p)** within 5°C of the specified classification temperature (T_c)	20** seconds	30** seconds
Average ramp-down rate (T_p to T_{smax})	6 °C/second max.	6 °C/second max.
Time 25°C to peak temperature	6 minutes max.	8 minutes max.
* Tolerance for peak profile Temperature (T_p) is defined as a supplier minimum and a user maximum.		
** Tolerance for time at peak profile temperature (t_p) is defined as a supplier minimum and a user maximum.		

Table 1. SnPb Eutectic Process – Classification Temperatures (T_c)

Package Thickness	Volume mm ³ <350	Volume mm ³ ≥350
<2.5 mm	235 °C	220 °C
≥2.5 mm	220 °C	220 °C

Table 2. Pb-free Process – Classification Temperatures (T_c)

Package Thickness	Volume mm ³ <350	Volume mm ³ 350-2000	Volume mm ³ >2000
<1.6 mm	260 °C	260 °C	260 °C
1.6 mm – 2.5 mm	260 °C	250 °C	245 °C
≥2.5 mm	250 °C	245 °C	245 °C

Reliability Test Program

Test item	Method	Description
SOLDERABILITY	JESD-22, B102	5 Sec, 245°C
HOLT	JESD-22, A108	1000 Hrs, Bias @ 125°C
PCT	JESD-22, A102	168 Hrs, 100%RH, 2atm, 121°C
TCT	JESD-22, A104	500 Cycles, -65°C~150°C

Attention

- 1, Any and all Winsok power products described or contained herein do not have specifications that can handle applications that require extremely high levels of reliability, such as life-support systems, aircraft's control systems, or other applications whose failure can be reasonably expected to result in serious physical and/or material damage. Consult with your Winsok power representative nearest you before using any Winsok power products described or contained herein in such applications.
- 2, Winsok power assumes no responsibility for equipment failures that result from using products at values that exceed, even momentarily, rated values (such as maximum ratings, operating condition ranges, or other parameters) listed in products specifications of any and all Winsok power products described or contained herein.
- 3, Specifications of any and all Winsok power products described or contained herein stipulate the performance, characteristics, and functions of the described products in the independent state, and are not guarantees of the performance, characteristics, and functions of the described products as mounted in the customer's products or equipment. To verify symptoms and states that cannot be evaluated in an independent device, the customer should always evaluate and test devices mounted in the customer's products or equipment.
- 4, Winsok power Semiconductor CO., LTD. strives to supply high-quality high-reliability products. However, any and all semiconductor products fail with some probability. It is possible that these probabilistic failures could give rise to accidents or events that could endanger human lives that could give rise to smoke or fire, or that could cause damage to other property. When designing equipment, adopt safety measures so that these kinds of accidents or events cannot occur. Such measures include but are not limited to protective circuits and error prevention circuits for safe design, redundant design, and structural design.
- 5, In the event that any or all Winsok power products (including technical data, services) described or contained herein are controlled under any of applicable local export control laws and regulations, such products must not be exported without obtaining the export license from the authorities concerned in accordance with the above law.
- 6, No part of this publication may be reproduced or transmitted in any form or by any means, electronic or mechanical, including photocopying and recording, or any information storage or retrieval system, or otherwise, without the prior written permission of Winsok power Semiconductor CO., LTD.
- 7, Information (including circuit diagrams and circuit parameters) herein is for example only; it is not guaranteed for volume production. Winsok power believes information herein is accurate and reliable, but no guarantees are made or implied regarding its use or any infringements of intellectual property rights or other rights of third parties.
- 8, Any and all information described or contained herein are subject to change without notice due to product/technology improvement, etc. When designing equipment, refer to the "Delivery Specification" for the Winsok power product that you intend to use.
- 9, this catalog provides information as of Sep. 2014. Specifications and information herein are subject to change without notice.

单击下面可查看定价，库存，交付和生命周期等信息

[>>WINSOK\(微硕\)](#)