



MPCS-101X Series

LSOP4, DC Input, High Switching Time Photo Transistor Coupler

Description

The MPCS-101X series combine an Light emitting diode as the emitter which is optically coupled to a silicon phototransistor enabling relatively high switching speed with high load resistor of several K Ω . The MPCS-101X is in a plastic LSOP4 package.

Features

- High isolation 5000 VRMS
- CTR flexibility available see order information
- DC input with transistor output
- MSL class 1
- Guaranteed performance over temperature -40°C ~ +110°C.

Applications

- Switch mode power supplies
- Programmable controllers
- Household appliances
- Office equipment

SCHEMATIC

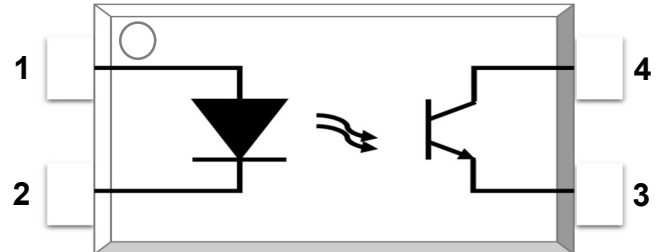

PIN DEFINITION

1. Anode
2. Cathode
3. Emitter
4. Collector

PACKAGE OUTLINE

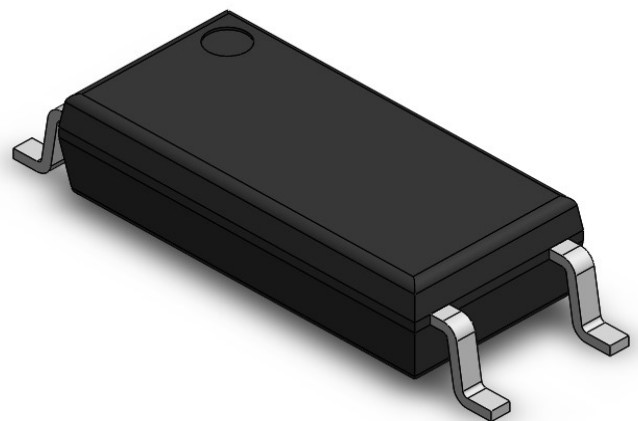



MPCS-101X Series

LSOP4, DC Input, High Switching Time Photo Transistor Coupler

ABSOLUTE MAXIMUM RATINGS

PARAMETER	SYMBOL	VALUE	UNIT	NOTE
INPUT				
Forward Current	IF	20	mA	
Reverse Voltage	VR	6	V	
Input Power Dissipation	PI	50	mW	
OUTPUT				
Collector - Emitter Voltage	VCEO	80	V	
Emitter - Collector Voltage	VECO	7	V	
Collector Current	IC	50	mA	
Output Power Dissipation	PO	150	mW	
COMMON				
Total Power Dissipation	Ptot	200	mW	
Isolation Voltage	Viso	5000	Vrms	1
Operating Temperature	Topr	-40~110	°C	
Storage Temperature	Tstg	-55~125	°C	
Soldering Temperature	Tsol	260	°C	2

Note 1. AC For 1 Minute, R.H. =40~60%

Note 2. For 10 Seconds



MPCS-101X Series

LSOP4, DC Input, High Switching Time Photo Transistor Coupler

ELECTRICAL OPTICAL CHARACTERISTICS

PARAMETER	SYMBOL	MIN.	TYP.	MAX.	UNIT	TEST CONDITION	NOTE
INPUT CHARACTERISTICS							
Forward Voltage	V_F	1.6	2.0	2.4	V	$I_F = 10 \text{ mA}$	
Input Reverse Current	I_R	-	-	10	μA	$V_R = 4\text{V}$	
Input Capacitance	C_{IN}	-	60	-	pF	$V = 0\text{V}, f = 1\text{MHz}$	
OUTPUT CHARACTERISTICS							
Collector Dark Current	I_{CEO}	-	10	100	nA	$V_{CE} = 20\text{V}, I_F = 0\text{mA}$	
Collector- Emitter Breakdown Voltage	BV_{CEO}	80	-	-	V	$I_C = 100\mu\text{A}, I_F = 0\text{mA}$	
Emitter -Collector Breakdown Voltage	BV_{ECO}	7	-	-	V	$I_E = 100\mu\text{A}, I_F = 0\text{mA}$	
TRANSFER CHARACTERISTICS							
Collector Current	I_C	2.5	-	30	mA	$I_F = 5 \text{ mA}, V_{CE} = 5\text{V}$	
Current Transfer Ratio	CTR	50	-	600	%	$I_F = 5 \text{ mA}, V_{CE} = 5\text{V}$	1
Collector-Emitter Saturation Voltage	$V_{CE(sat)}$	-	-	0.3	V	$I_F = 10 \text{ mA}, I_C = 1\text{mA}$	
Isolation Resistance	Riso	1×10^{12}	-	-	Ω	DC500V, 40 ~ 60% R.H.	
Floating Capacitance	C_f	-	0.3	-	pF	$V = 0\text{V}, f = 1\text{MHz}$	
Response Time (Rise)	t_r		0.3	10	us	$V_{CC} = 5 \text{ V}, I_F = 5 \text{ mA},$ $RL = 1 \text{ k}\Omega$	2
Response Time (Fall)	t_f		1.3	10			
Turn-on Time	T_{on}		0.5	10			
Turn-off Time	T_{off}		4.5	10			

Note 1: $CTR = I_C / I_F \times 100\%$.

Note 2: Fig.13&14.

RANK TABLE OF CTR (CURRENT TRANSFER RATIO)

CTR Rank	Min.	Typ.	Max.	Unit	Test Condition
MPCS-1010	50	-	600	%	$I_F = 5 \text{ mA}, V_{CE} = 5\text{V}$
MPCS-1017	80	-	160	%	
MPCS-1018	130	-	260	%	
MPCS-1019	200	-	400	%	



MPCS-101X Series

LSOP4, DC Input, High Switching Time Photo Transistor Coupler

TYPICAL PERFORMANCE CURVES & TEST CIRCUITS

Fig.1 IF vs. VF

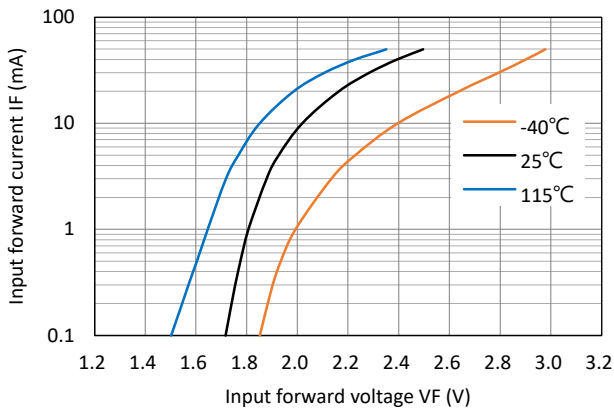

Fig.2 Dark Current vs. Ta

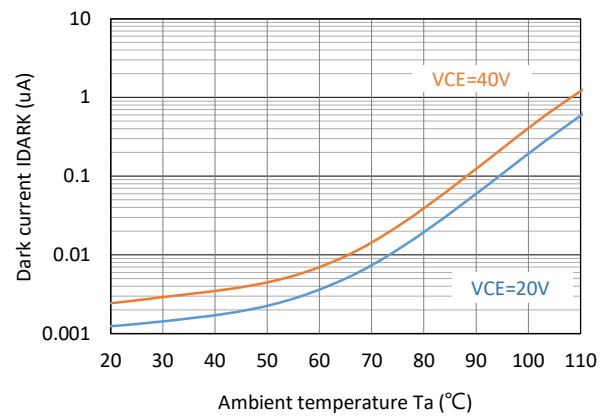

Fig.3 IC vs. VCE

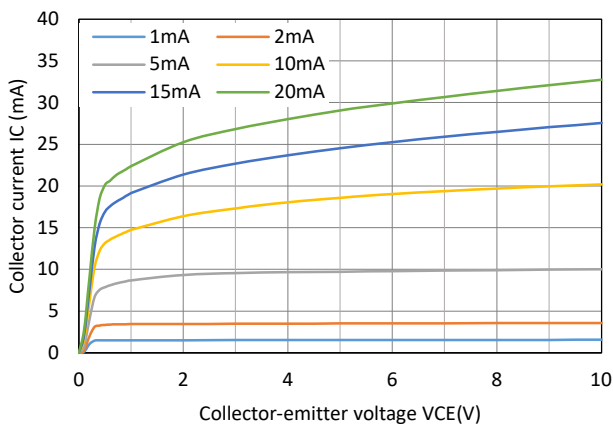

Fig.4 IC vs. VCE

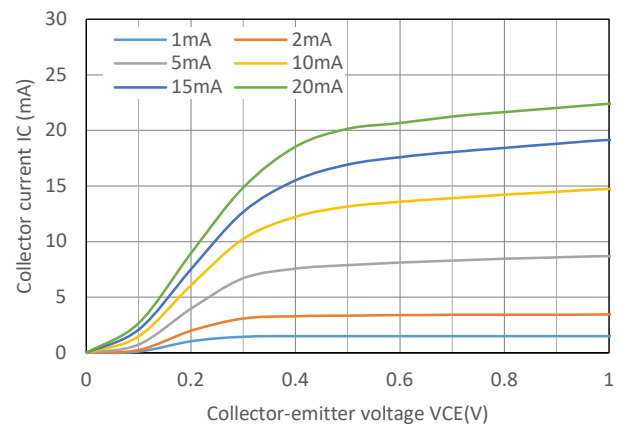

Fig.5 IC vs. IF

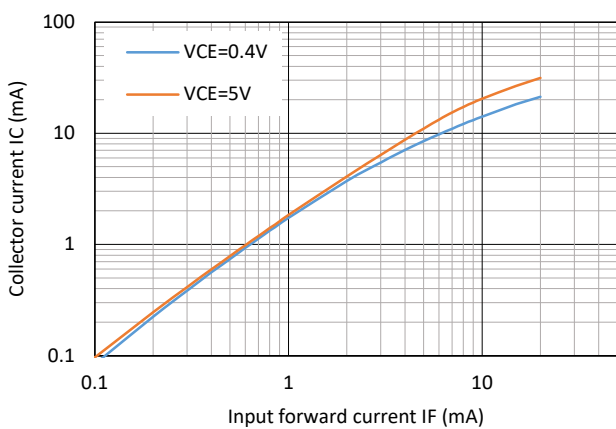
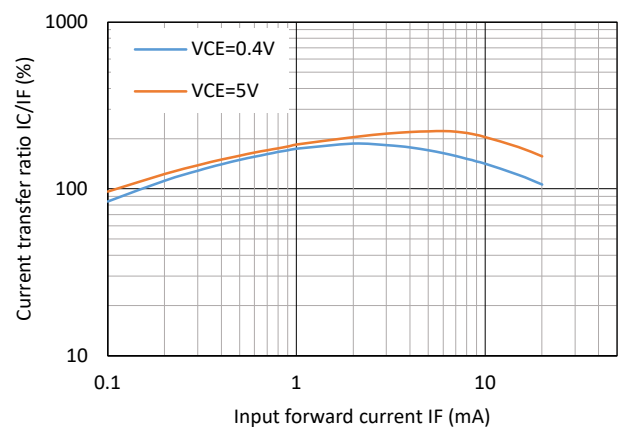

Fig.6 CTR vs. IF





MPCS-101X Series

LSOP4, DC Input, High Switching Time Photo Transistor Coupler

Fig.7. I_c vs. T_a

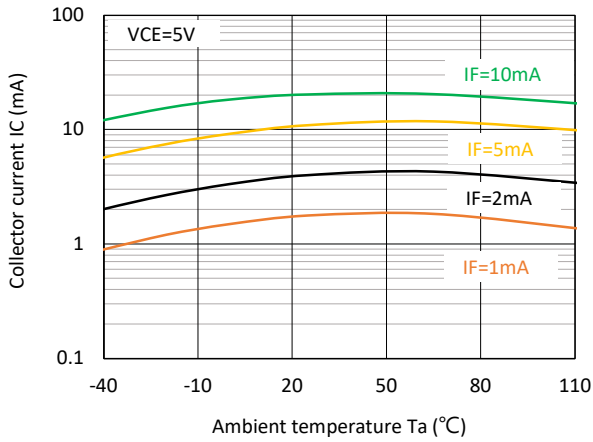

Fig.8 Normalized CTR vs. T_a

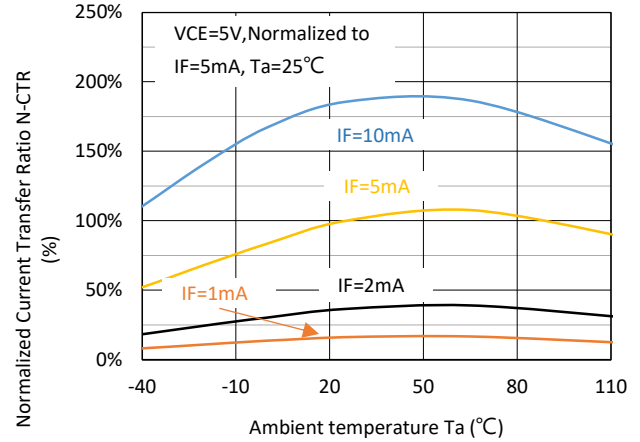

Fig.9 $V_{CE(sat)}$ vs. T_a

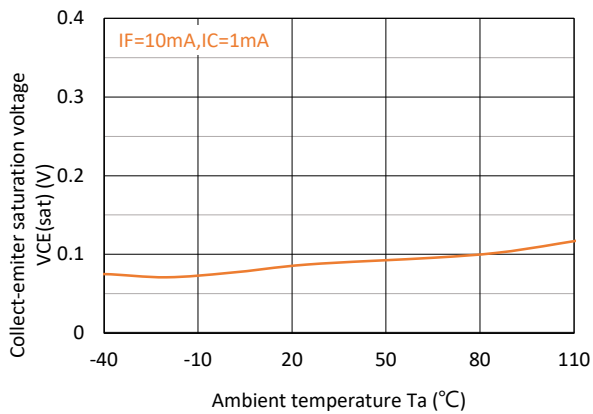

Fig.10 Switching Time vs. I_F

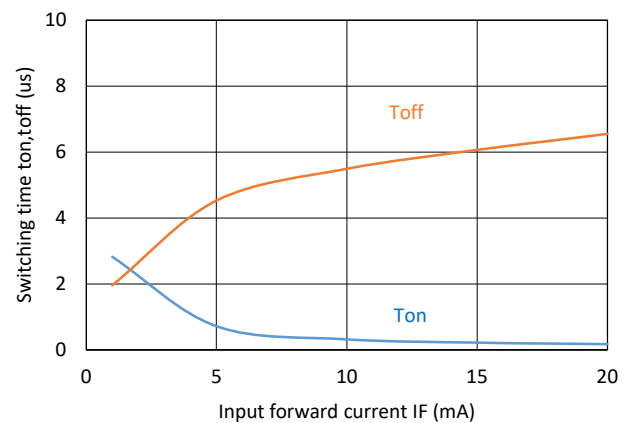

Fig.11 Switching Time vs. R_L

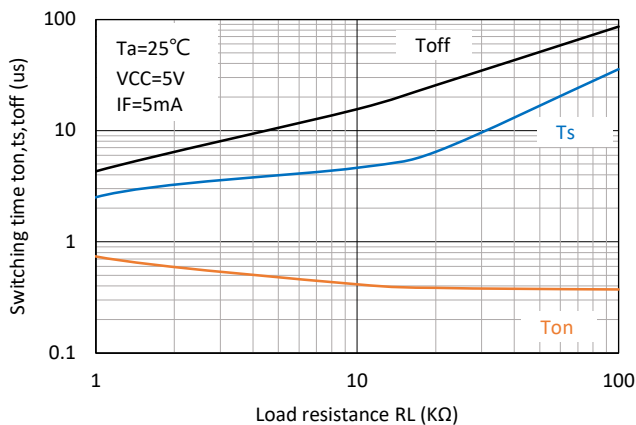

Fig.12 Switching Time vs. T_a

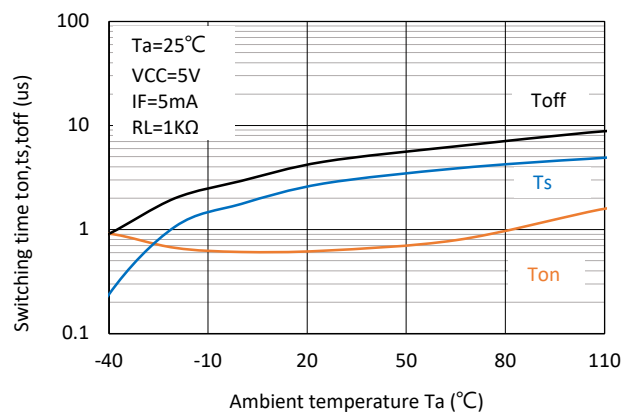

Fig.13 Test Circuits of Switching Time

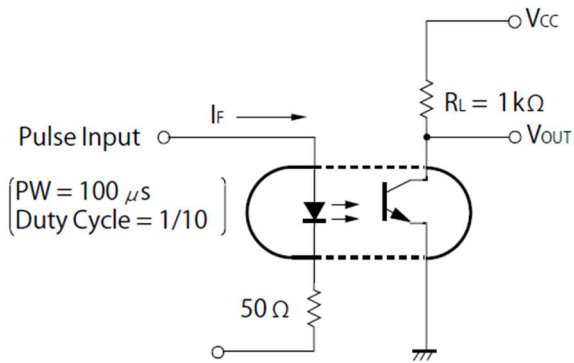
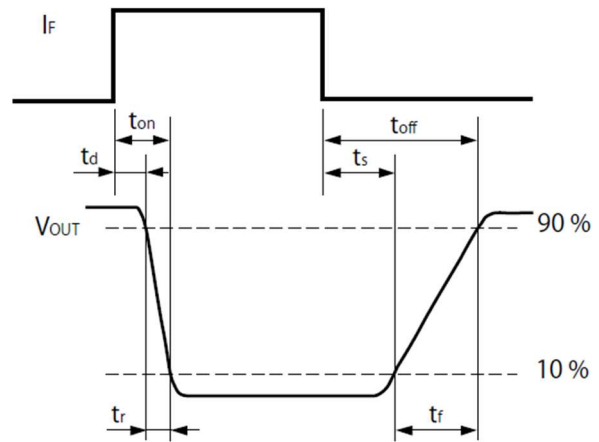
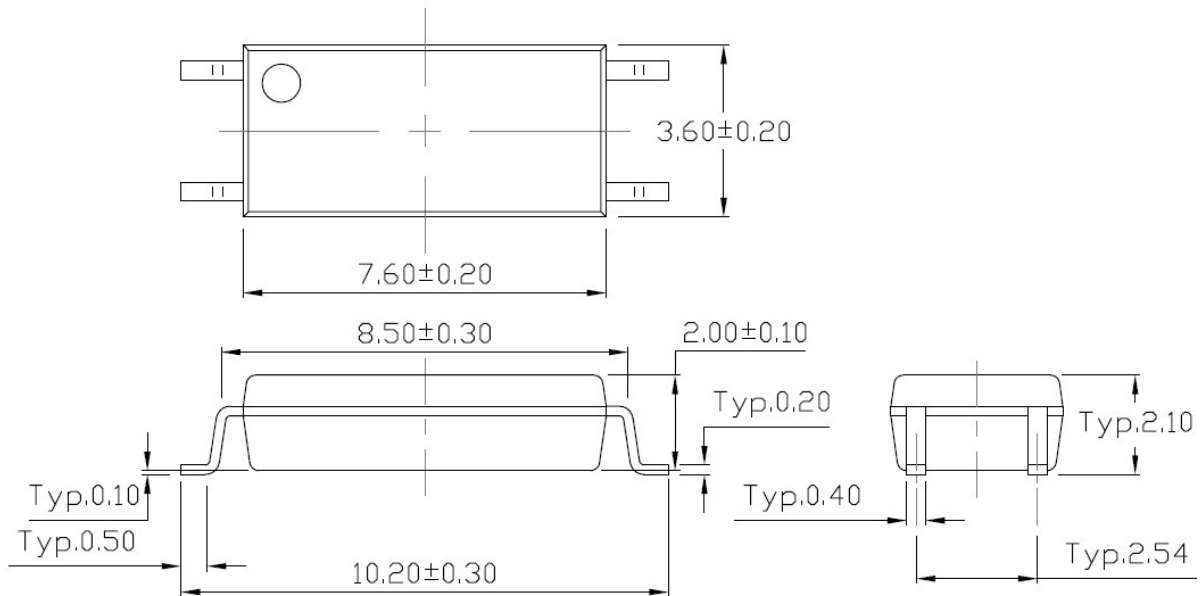

Fig.14 Curves of Switching Time



PACKAGE DIMENSIONS (Dimensions in mm unless otherwise stated)



RECOMMENDED SOLDER MASK (Dimensions in mm unless otherwise stated)

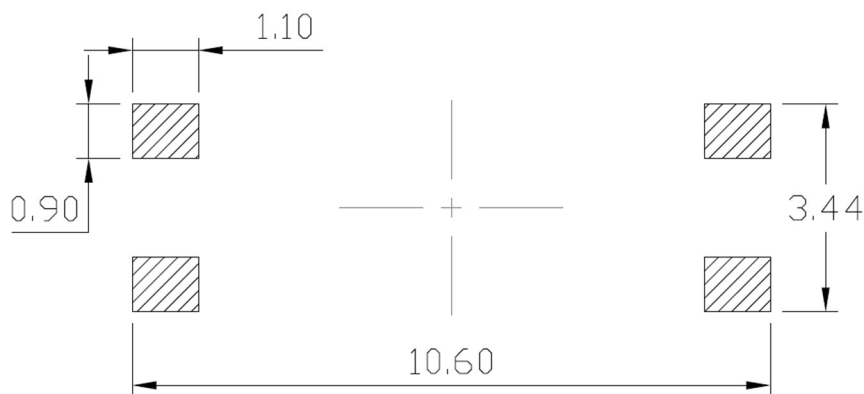



MPCS-101X Series

LSOP4, DC Input, High Switching Time Photo Transistor Coupler

CARRIER TAPE SPECIFICATIONS (Dimensions in mm unless otherwise stated)

Option T1

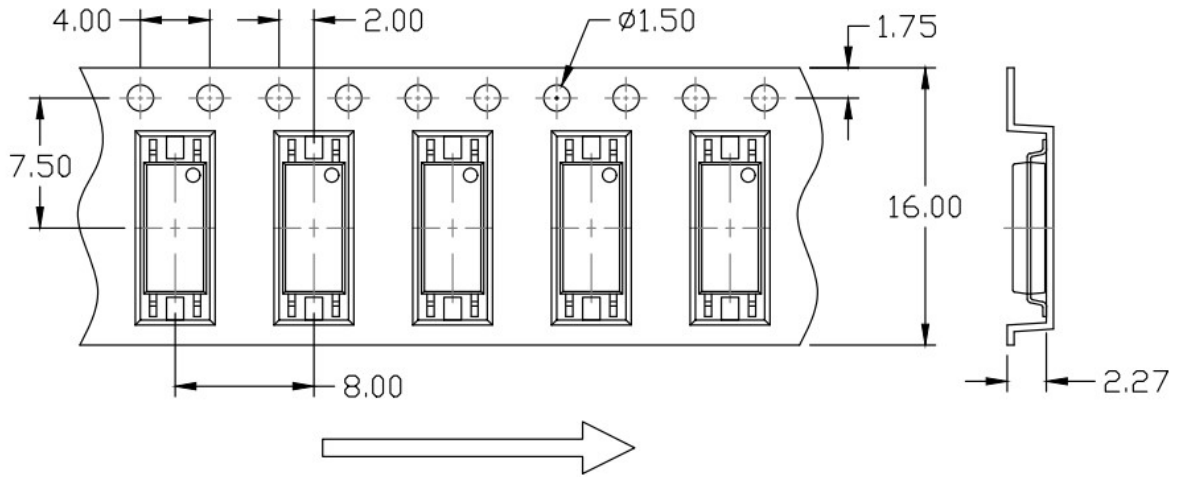

Option T2

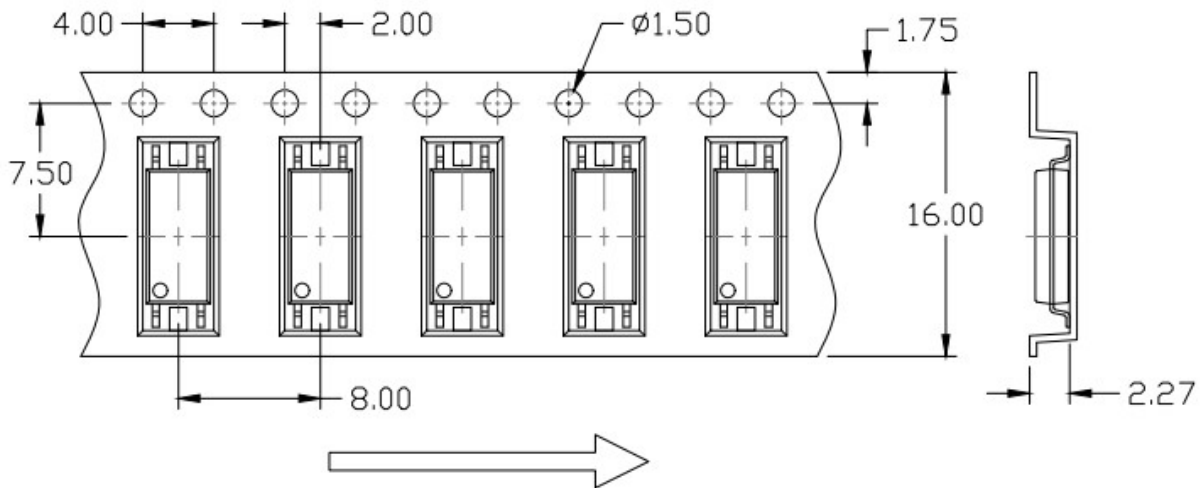



MPCS-101X Series

LSOP4, DC Input, High Switching Time Photo Transistor Coupler

REEL SPECIFICATIONS (Dimensions in mm unless otherwise stated)

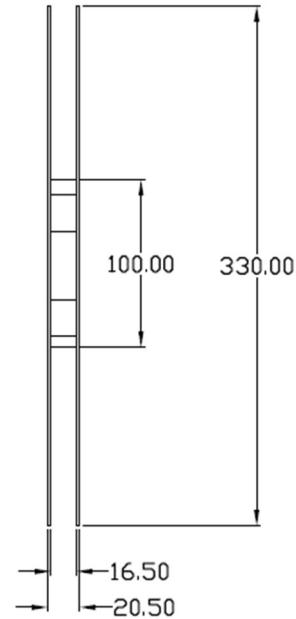
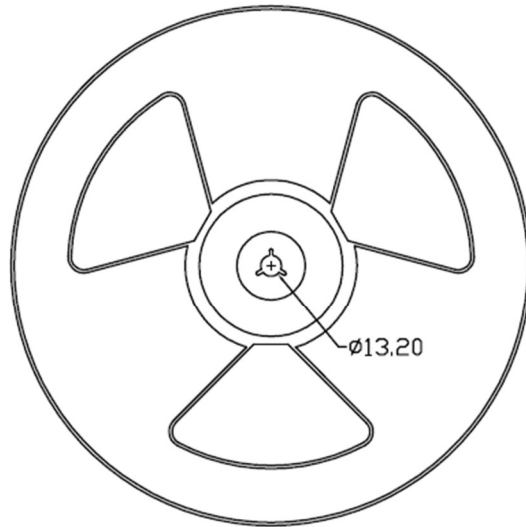

BOX SPECIFICATIONS (Reel Type)

INNER BOX

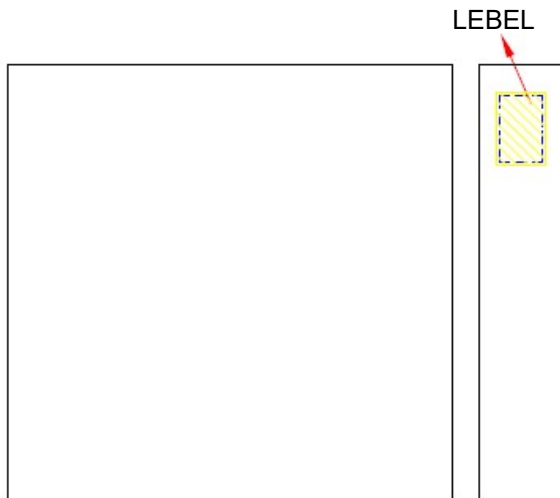

L x W x H = 36cm x 36cm x 6.9cm

OUTER BOX

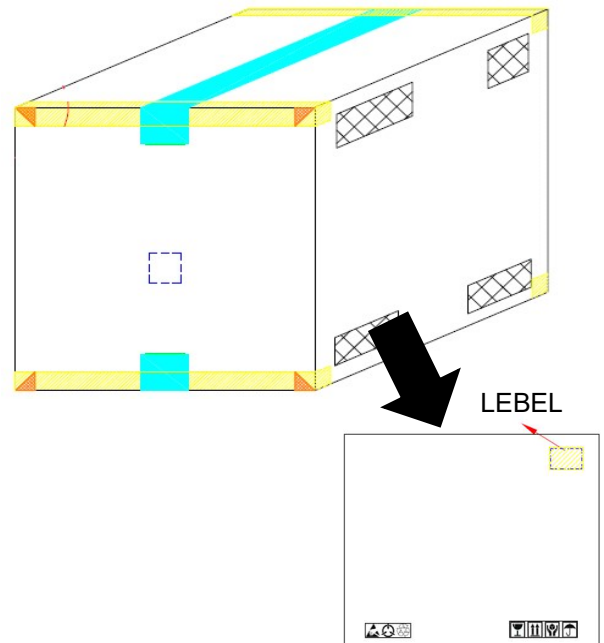

L x W x H = 45cm x 38cm x 38cm

Rev: 2.1

Release Date: 2023/11/24



MPCS-101X Series

LSOP4, DC Input, High Switching Time Photo Transistor Coupler

ORDERING AND MARKING INFORMATION

MARKING INFORMATION

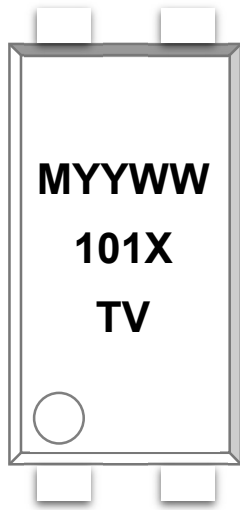

M : Company Abbr.
 YY : Year date code
 WW : 2-digit work week
 101 : Part Number
 X : CTR Rank
 T : Factory identification mark
 V :VDE Identification(Option)

ORDERING INFORMATION

MPCS-101X(Z)-GV

MPC – Company Abbr.
 S – Stack
 101 – Part Number
 X – CTR Rank
 Z – Tape and Reel Option (T1/T2)
 G – Green Part
 V – VDE Option (V or None)

LABEL INFORMATION



PACKING QUANTITY

Option	Quantity	Quantity – Inner box	Quantity – Outer box
T1	3000 Units/Reel	3 Reels/Inner box	5 Inner box/Outer box = 45k Units
T2	3000 Units/Reel	3 Reels/Inner box	5 Inner box/Outer box = 45k Units



MPCS-101X Series

LSOP4, DC Input, High Switching Time Photo Transistor Coupler

REFLOW INFORMATION

REFLOW PROFILE

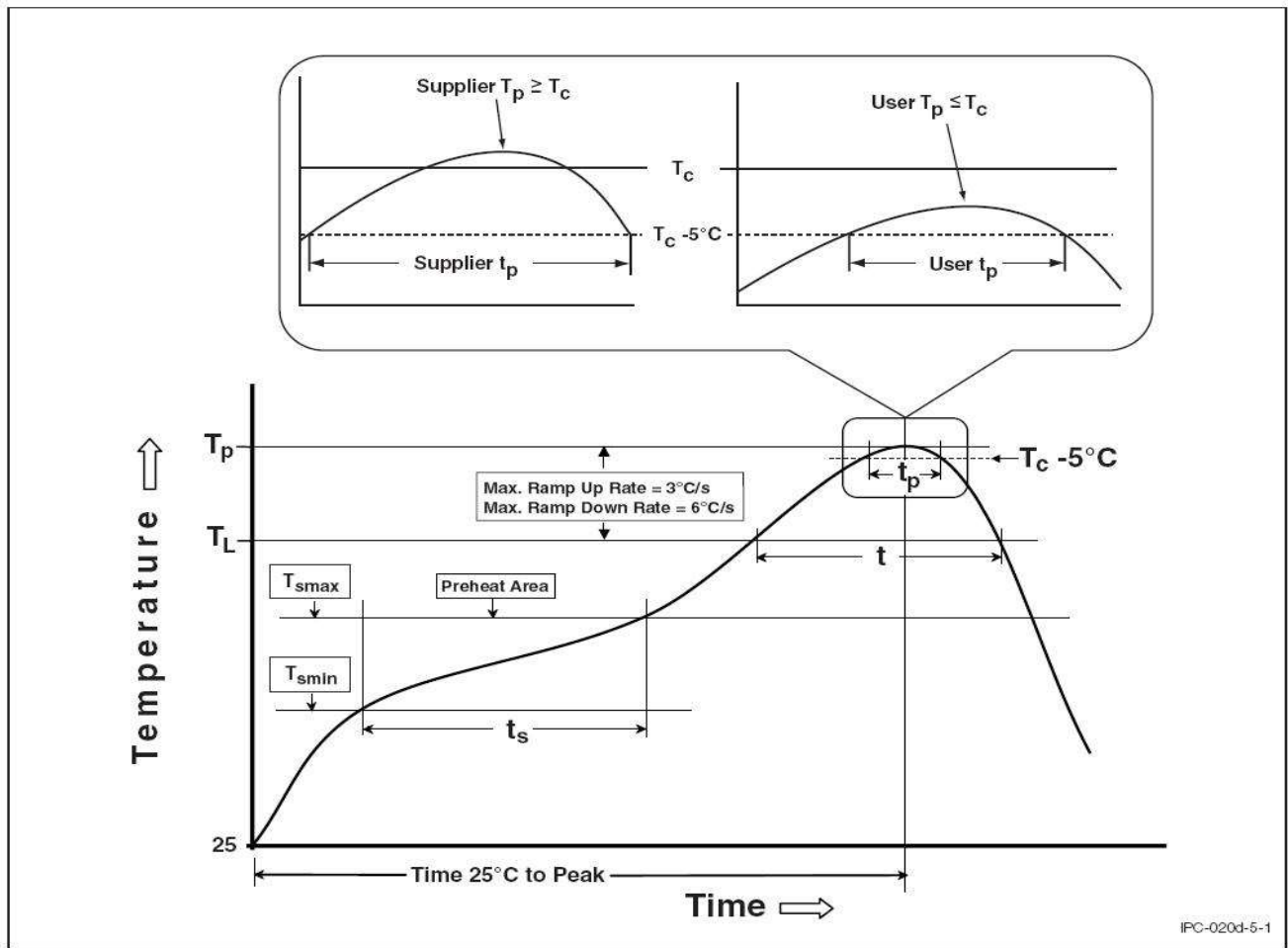

Profile Feature	Sn-Pb Assembly Profile	Pb-Free Assembly Profile
Temperature Min. (T _{smin})	100°C	150°C
Temperature Max. (T _{smax})	150°C	200°C
Time (t _s) from (T _{smin} to T _{smax})	60-120 seconds	60-120 seconds
Ramp-up Rate (t _L to t _P)	3°C/second max.	3°C/second max.
Liquidous Temperature (T _L)	183°C	217°C
Time (t _L) Maintained Above (T _L)	60 – 150 seconds	60 – 150 seconds
Peak Body Package Temperature	235°C +0°C / -5°C	260°C +0°C / -5°C
Time (t _P) within 5°C of 260°C	20 seconds	30 seconds
Ramp-down Rate (T _P to T _L)	6°C/second max	6°C/second max
Time 25°C to Peak Temperature	6 minutes max.	8 minutes max.



MPCS-101X Series

LSOP4, DC Input, High Switching Time Photo Transistor Coupler

TEMPERATURE PROFILE OF SOLDERING

WAVE SOLDERING (JESD22-A111 COMPLIANT)

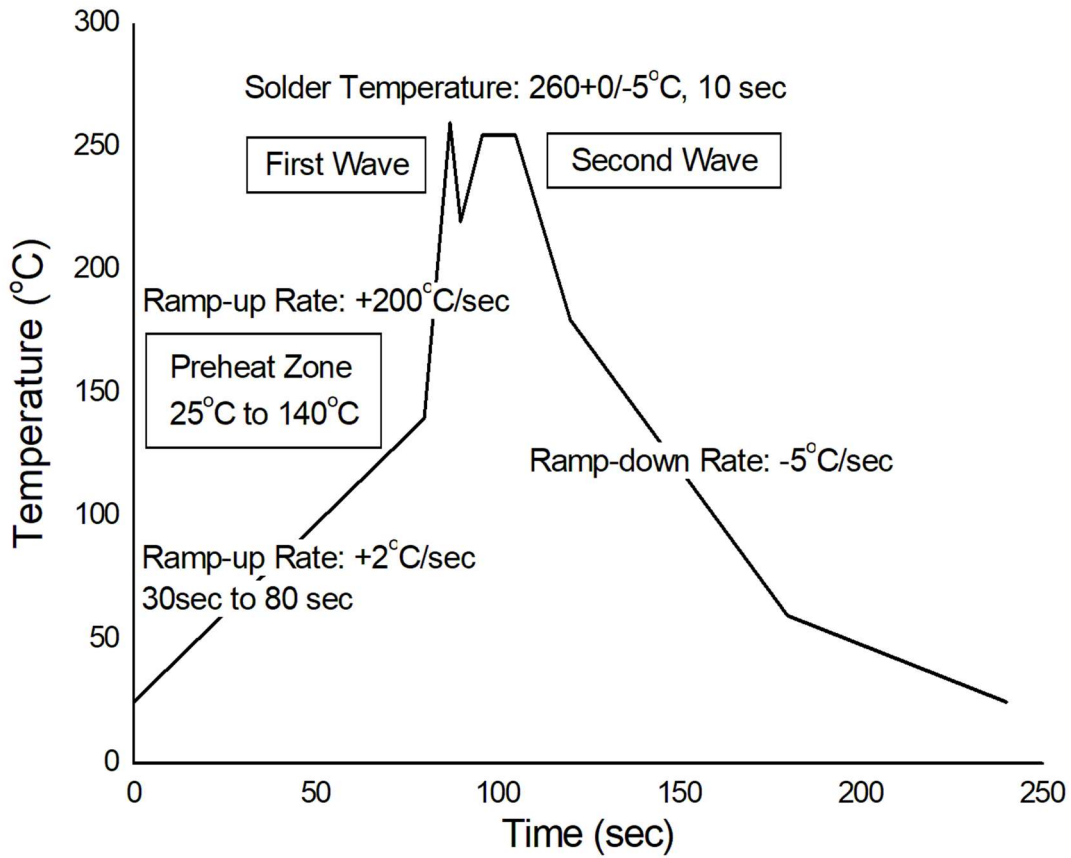

HAND SOLDERING BY SOLDERING IRON

Soldering Temperature	380±5°C
-----------------------	---------

Soldering Time	3 sec max.
----------------	------------

One time soldering is recommended for all soldering method.

Do not solder more than three times for IR reflow soldering.



DISCLAIMER

- WISELITE is continually improving the quality, reliability, function and design. WISELITE reserves the right to make changes without further notices.
- The characteristic curves shown in this datasheet are representing typical performance which are not guaranteed.
- WISELITE makes no warranty, representation or guarantee regarding the suitability of the products for any particular purpose or the continuing production of any product. To the maximum extent permitted by applicable law, WISELITE disclaims (a) any and all liability arising out of the application or use of any product, (b) any and all liability, including without limitation special, consequential or incidental damages, and (c) any and all implied warranties, including warranties of fitness for particular.
- The products shown in this publication are designed for the general use in electronic applications such as office automation, equipment, communications devices, audio/visual equipment, electrical application and instrumentation purpose, non-infringement and merchantability.
- This product is not intended to be used for military, aircraft, medical, life sustaining or lifesaving applications or any other application which can result in human injury or death.
- Please contact WISELITE sales agent for special application request.
- Immerge unit's body in solder paste is not recommended.
- Parameters provided in datasheets may vary in different applications and performance may vary over time. All operating parameters, including typical parameters, must be validated in each customer application by the customer's technical experts. Product specifications do not expand or otherwise modify WISELITE's terms and conditions of purchase, including but not limited to the warranty expressed therein.
- Discoloration might be occurred on the package surface after soldering, reflow or long-time use. It neither impacts the performance nor reliability.

单击下面可查看定价，库存，交付和生命周期等信息

[>>WISELITE\(蓝光\)](#)