

## Summary

GT712 is a high-performance Hall effect current sensor that can more effectively measure AC (alternating current) or DC (direct current) current, and is widely used in industrial, consumer, and communication equipment.

The GT712 series internally integrates a highly accurate and low-noise linear Hall circuit and a low-impedance main current loop conductor. When the sampled current flows through the main current loop, the magnetic field it generates induces a corresponding electrical signal on the Hall circuit, which is then processed by the signal processing circuit to output a voltage signal, making the product output strictly proportional to the measured current value.

The linear Hall circuit is manufactured using advanced BCDMOS process, which includes a high sensitivity Hall sensor, a preamplifier for the Hall signal, a high precision Hall temperature compensation unit, an oscillator, a dynamic offset elimination circuit, and an output module for the amplifier. In the absence of a magnetic field, the static output of the current sensor is 50% VCC. Under a power supply voltage of 5V, the sensor's static output can linearly change between 0.2~4.8V with the magnetic field, with a linearity of up to 0.4%.

The dynamic offset elimination circuit integrated inside the GT712 ensures that the sensitivity of the sensor is not affected by external pressure and IC packaging stress. The GT712 is available in SOP8 package, with an operating temperature range of -40~150°C, and complies with RoHS standards.

## Main features

- Working voltage: 4.5V~5.5V
- Static common mode output point: 50% VCC
- Wide measuring range: 5A/20A/30A
- Isolation voltage: 2500V
- High bandwidth: 120kHz
- Output response time: 4μs (typical value)
- Stability within operating range: 1.5% @ 25°C~150°C; 1% @ -40°C~25°C
- Low-noise analog signal path
- Strong anti-interference ability
- Strong resistance to mechanical stress, magnetic field parameters  
Strong resistance to mechanical stress, magnetic field parameters are not shifted by external pressure
- ESD (HBM): 5kV
- Operating temperature: -40°C~150°C
- RoHS certified: (EU) 2015 / 863
- Proportional output, bidirectional current



## Application scope

- Inverter current detection
- Motor phase current detection (motor control)
- Photovoltaic inverter
- Battery Load Testing System
- Current Transformer
- Switching Power Supply
- Overload Protection Device

## Order Information

Product Model	Package Type	Marking	Packing	Packing Qty
GT712LBDTR-05B	SOP-8	GT712LB 05B XXX XBLW	Tape	3000PCS/Reel
GT712LBDTR-20A	SOP-8	GT712LB 20A XXX XBLW	Tape	3000PCS/Reel
GT712LBDTR-20A	SOP-8	GT712LB 30A XXX XBLW	Tape	3000PCS/Reel

## Functional Block Diagram

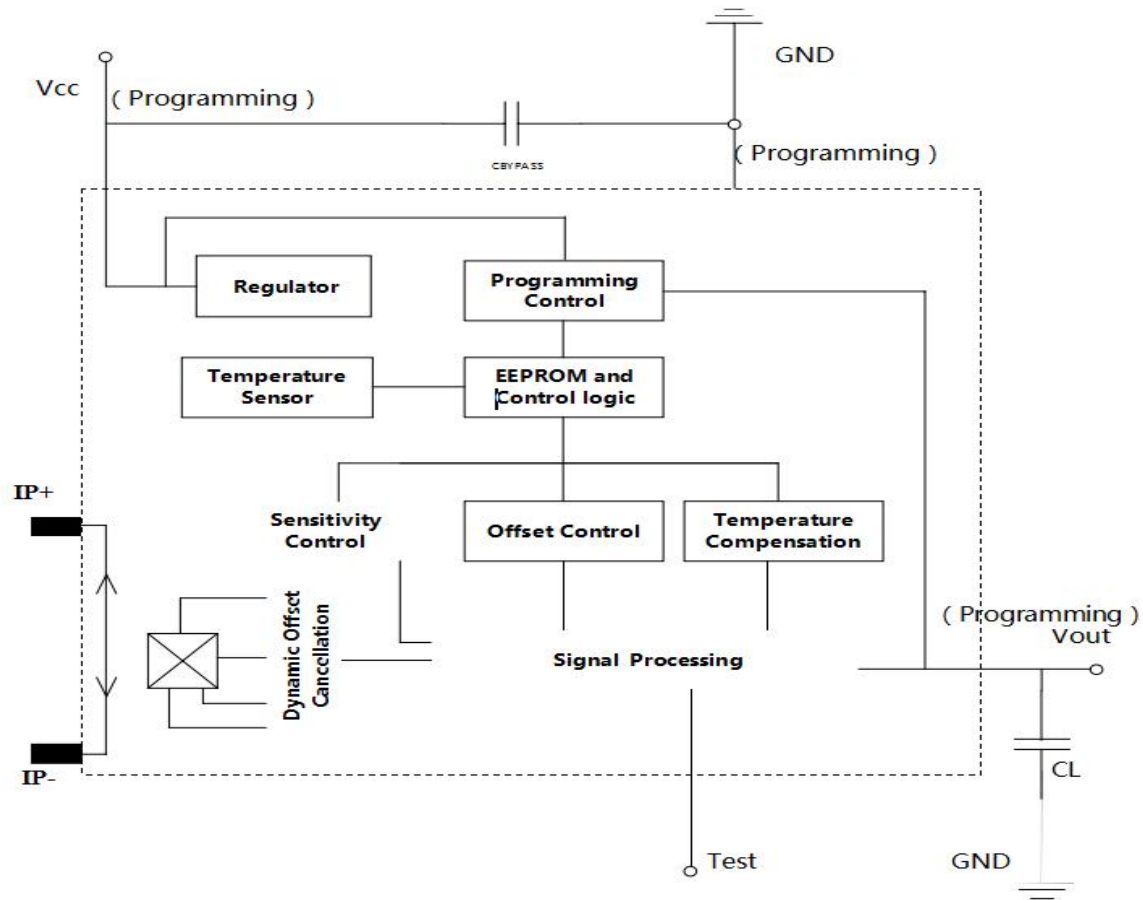

## Pin Information

Name	Number	Function	Name	Number	Function
IP+	1	positive current input terminal	GND	5	Ground/Programming Pin
IP+	2	positive current input terminal	TEST	6	Factory Testing/Floating
IP-	3	negative current input terminal	OUT	7	Signal Output/Programming Pin
IP-	4	negative current input terminal	VCC	8	Power Supply/Programming Pin

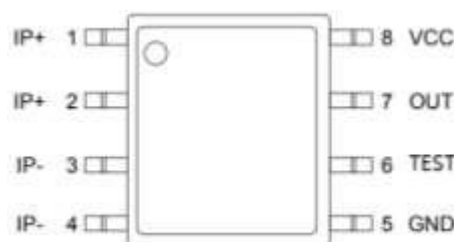

## Limiting Parameter

Using the device beyond its limiting parameters may cause instability of the chip's functions, and prolonged exposure to such conditions may damage the chip.

Symbol	Parameter	Minimum value	Maximum value	Unit
VCC	Power supply voltage	-	6	V
VOUT	Output voltage	-	VCC-0.5	V
IOUT (source)	Output current source	-	80	mA
IOUT (sink)	Output current sink	-	40	mA
TA	Working Environment Temperature	-40	150	°C
TS	Storage Temperature	-65	170	°C
TJ	Maximum Junction Temperature	-	165	°C
Endurance	EEPROM Programming cycle number	200	-	cycle
Transient surge current at current sampling terminal	IP1pulse100ms		100	A

## Electrostatic Discharge(ESD) parameters

Symbol	Execution Standard	Maximum Value	Unit
VESD Human Body Model (HBM)	JEDECJS-001-2017	5	kV

## Electrical parameters

Symbol	Parameter	Test conditions	Minimum value	Typical value	Maximum value	Unit
VCC	Operating voltage	-	4.5	5	5.5	V
ICC	Operating current	TA=25°C, Output No Load	9	11.18	13	mA
BW	Built-in bandwidth	Smallsignal: -3dB, CL=1nF, TA=25°C	-	120	-	KHz
TPO	Power-on time	TA=25°C, CL=1nF, Sensitivity 2mV/G, Constant Magnetic Field: 400Gs		100		us
TTC	Temperature-compensated power-on time	TA=150°C, CL=1nF, Sensitivity 2mV/G, Constant Magnetic Field: 400Gs	-	300	-	us
VUVLOH	Undervoltage lockout threshold	TA=25°C, Voltage rises, Device starts operating.		4.1		V
VUVLOL		TA=25°C, Voltage drops, Device stops operating.		3.8		V
VPORH	Reset voltage	TA=25°C, VCC rises.	-	4.1	-	V
VPORL		TA=25°C, VCC drops.	-	3.8	-	V
tPORR	Power-on reset release time	TA=25°C, VCC rises.	-	10	-	us
ISCLP	Maximum current source			80		mA
ISCLN	Maximum sink current	-	-	40	-	mA
VOL	Analog output saturation low level	RL>=4.7KΩ		0.5		V
VOH	Analog output saturation high level	RL>=4.7KΩ	VCC-0.3	-	4.97	V

CL	Output load capacitance	VOUTtoGND	-	0.5	1	nF
RL	Output load resistance	VOUTtoGND		10	-	KΩ
		VOUTtoVCC		10		KΩ
ROUT	Output resistance	-		9		Ω
tR	Rise time	TA=25°C, constant magnetic field 400Gs, CL=1nF, sensitivity 2mV/Gs.	-	5.5	-	us
TPD	Transmission delay	TA=25°C, constant magnetic field 400Gs, CL=1nF, sensitivity 2mV/Gs.		4.5		us
TRESP	Response time	TA=25°C, constant magnetic field 400Gs, CL=1nF, sensitivity 2mV/Gs.	-	4	5	us
VN	Noise	TA=25°C, CL=1nF, sensitivity 2mV/Gs, BWf=Bwi.	-	14.1	-	mVp-p
RP	Main Current End Resistance			1.5	1.8	mΩ
Elin	Linear Error	TA=25°C, CL=1nF, sensitivity 2mV/Gs, BWf=Bwi.	-	0.4		%
Voq	Quiescent Point	TA=25°C, CL=1nF, sensitivity 2mV/Gs, BWf=Bwi.	2.485	2.500	2.515	V

## Accuracy parameter

### GT712LBDTR-05B

Parameter.	Symbol.	Condition	Minimum value	Typical value	Maximum value	Unit
current range	IP			±5		A
Zero Current Output Temperature Coefficient	$\Delta V_{OUT}(Q)$			0.26		mV/°C
Total Output Error	ETOT		-3.0		3.0	%
Output Noise	VNOISE(PP)			46		mV
Sensitivity	Sens	Full Current Range	180	185	190	mV/A
Sensitivity Temperature Coefficient	$\Delta Sens$	TA=150°C, TA=-40°C relative to 25°C		0		%/°C

### GT712LBDTR-20A

Parameter	Symbol	Condition	Minimum value	Typical value	Maximum value	Unit
Current Range	IP		-20		20	A
Zero Current Output Temperature Coefficient	$\Delta V_{OUT}(Q)$			0.26		mV/°C
Total Output Error	ETOT		-3.0		3.0	%
Output Noise	VNOISE(PP)			30		mV
Sensitivity	Sens	Full Current Range	96	100	104	mV/A
Sensitivity Temperature Coefficient	$\Delta Sens$	TA=150°C, TA=-40°C relative to 25°C		0		%/°C

## GT712LBDTR-30A

Parameter	Symbol	Condition	Minimum value	Typical value	Maximum value	Unit
Current Range	IP		-30		30	A
Zero Current Output Temperature Coefficient	$\Delta V_{OUT}(Q)$			0.26		mV/°C
Total Output Error	ETOT		-3.0		3.0	%
Sensitivity	Sens	Full Current Range	64	66.6	69	mV/A
Thermal coefficient of sensitivity	$\Delta Sens$	$T_A=150^{\circ}C$ , $T_A=-40^{\circ}C$ , relative to $25^{\circ}C$		0		%/°C
Output Noise	$V_{NOISE}(PP)$			20		mV

## Feature definition

### 1. Power-on Time - TPO

Power-on time: The time taken for the power supply to reach the minimum operating voltage  $V_{CCMIN}$  is  $t_1$ ; the time taken for the output to reach 90% of its steady value under an external magnetic field is  $t_2$ . The difference between these two times is the power-on time.

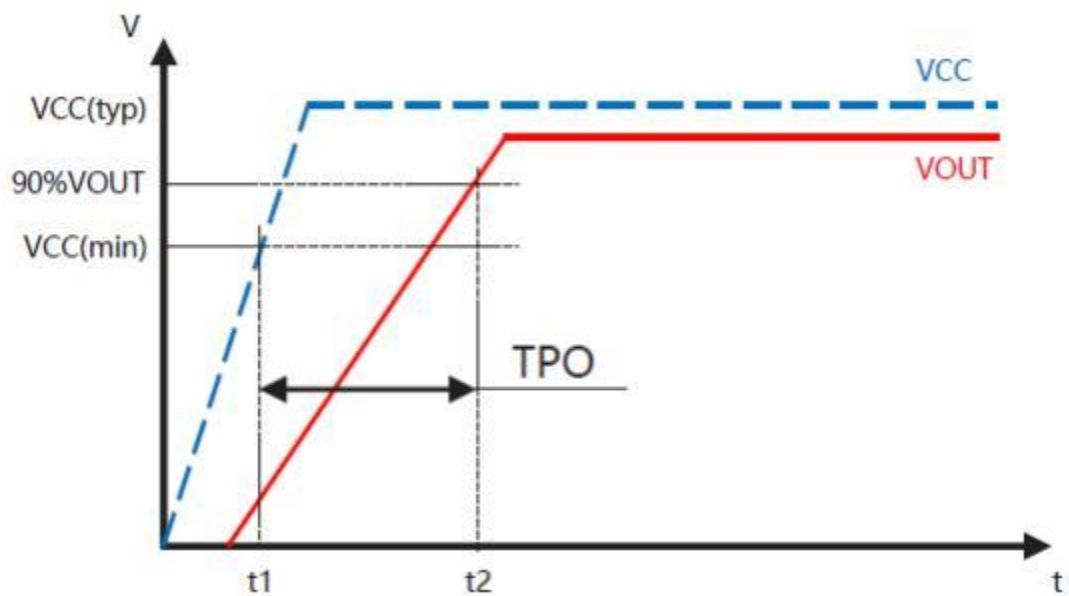

Figure 1: Definition of Power-on Time



## 2. Temperature Compensated Power-on Time - TTC

After power-on, temperature trimming time is required before valid temperature compensation output.

## 3. Transmission Delay - TPD

The time difference between the output reaching 20% of its final value when the external magnetic field reaches 20% of its final value.

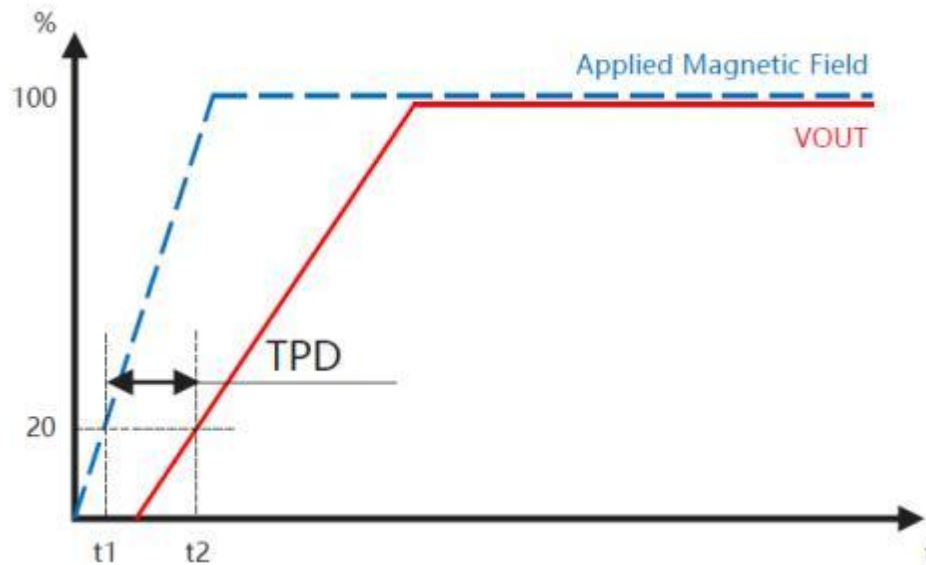

## 4. Rise time - TR

The time difference between the rise of the chip output level from 10% to 90%.

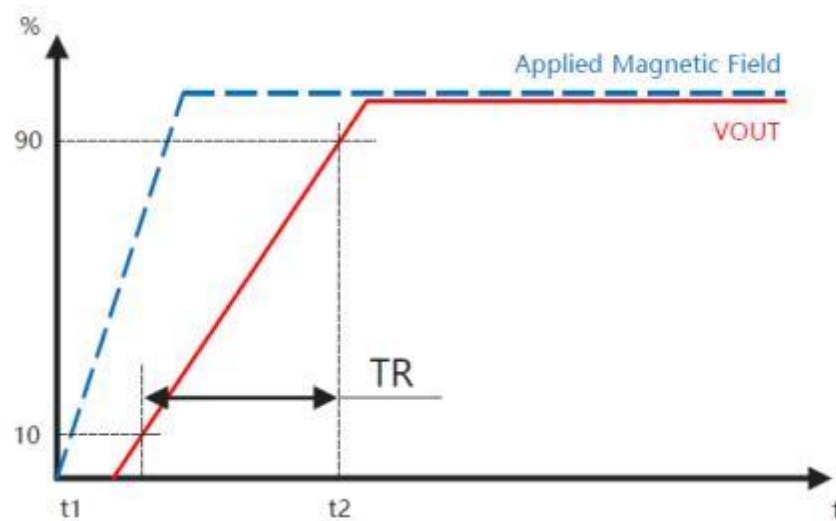
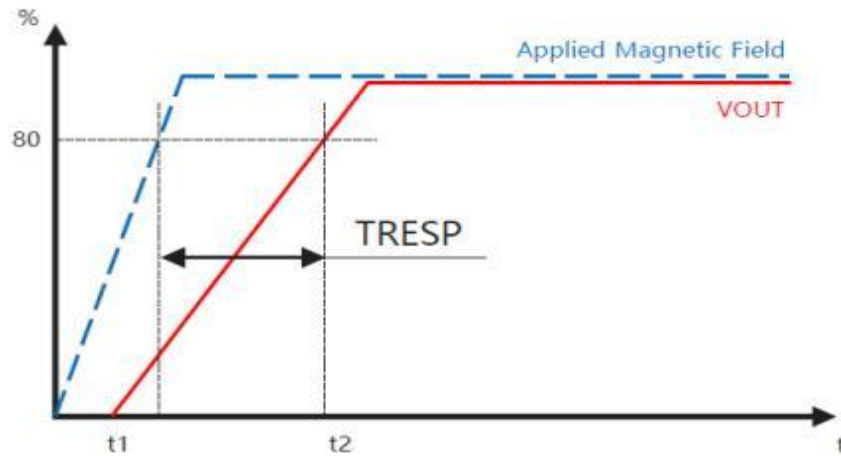

Figure 3: Definition of Rise Time

## 5. Response Time - TRESP

The time difference between when the external magnetic field applied to the chip reaches 80% of its final value and when the corresponding output value also reaches 80%.



## 6. Static Voltage Output - VOQ

Under the condition that the power supply voltage of the chip and the ambient temperature are within the operating range, and the measured current is 0, the output of the chip is...

Note: Prolonged operation at the maximum rated value may affect the reliability of the device. Exceeding the maximum rated value may damage the device.

## 7. Static Voltage Output Error - VOE

The difference between the actual output voltage of the sensor and the ideal output voltage power supply when the measured current value is zero. In proportional output mode with power supply, the static voltage output error is the difference between the actual output error and  $VCC / 2$ .

## 8. Sensitivity

Sensitivity indicates the change value of sensor output per 1A change of measured current, with the unit of mV/A. The calculation method is to pass through the positive full-scale current and negative full-scale current, and divide the difference between the output voltage at 2 points of the sensor by the difference between the positive full-scale current and negative full-scale current, which is the sensitivity of the sensor. The specific calculation formula is as follows:

$$\text{SENS} = (V_{\text{out}}(\text{IPma0}) - V_{\text{out}}(\text{Inma0})) / (\text{IPma0} - \text{Inma0})$$

Here, IPma0 and Inma0 are the positive full-scale current and negative full-scale current respectively,  $V_{\text{out}}(\text{IPma0})$  and  $V_{\text{out}}(\text{Inma0})$  are the analog output voltages of the sensor when passing through the positive full-scale current and negative full-scale current respectively.

## 9. Global Error Budget - ETOT

This error value represents the maximum error of the sensor under various environmental conditions, which is equal to the absolute value of the measurement error within each temperature range, divided by the maximum output dynamic range of the sensor, over the full current measurement range. It can be expressed as follows:

$$ETOT(IP) = \frac{Ma0(V_{out} - V_{out\_idea})}{(V_{out}(IP_{ma0}) - V_{oq})}$$

Here,  $Ma0 (V_{out} - V_{out\_idea})$  represents the maximum error within the measurement range and  $(V_{out}(IP_{ma0}) - V_{oq})$  represents the maximum output dynamic range of the sensor.

## 10. Non-linearity error - ELIN

Due to the non-ideal characteristics of the sensor, the output voltage is not completely linear with the measured current in practical applications. After linear fitting by least squares method, the linearity error of the sensor can be obtained by dividing the maximum output error of the sensor by its dynamic range, i.e.  $ELIN (IP) = \Delta V_{out} / (V_{out}(IP_{ma0}) - V_{oq})$ . Here,  $\Delta V_{out}$  is the maximum linearity error within the measuring range of the sensor.

## Characteristic curve

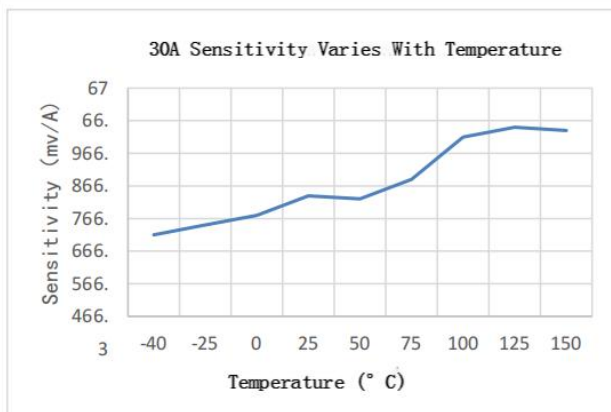
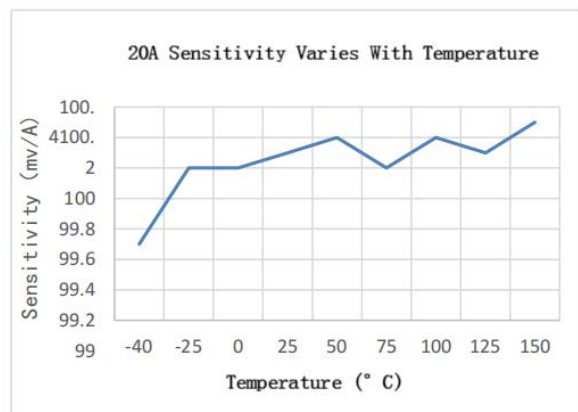
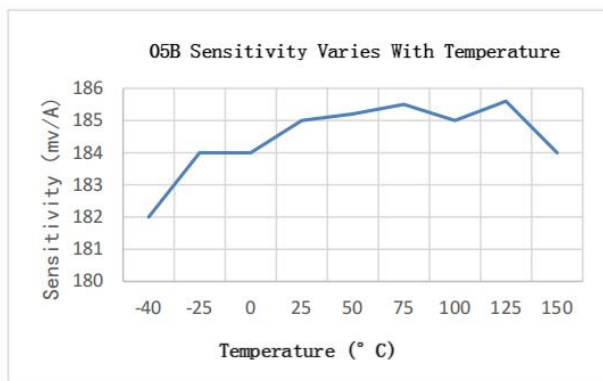
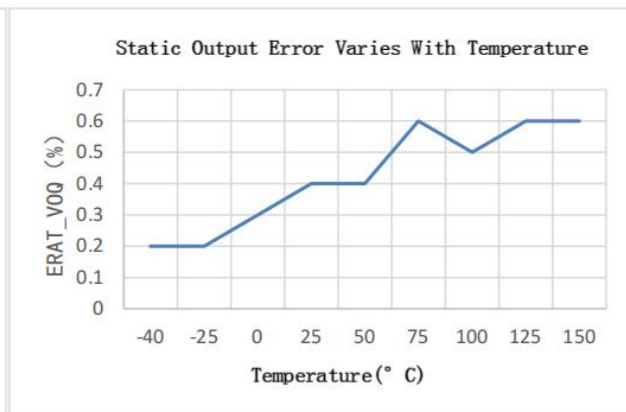
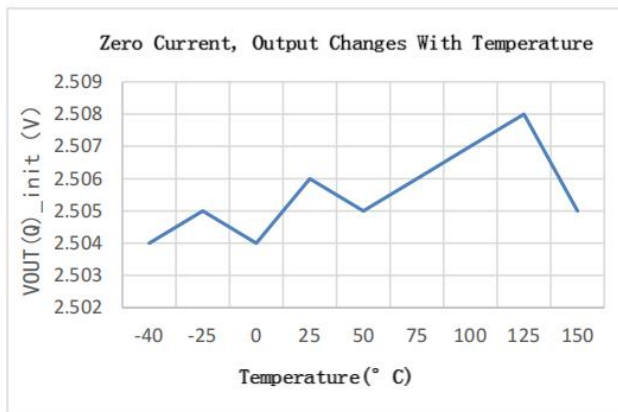
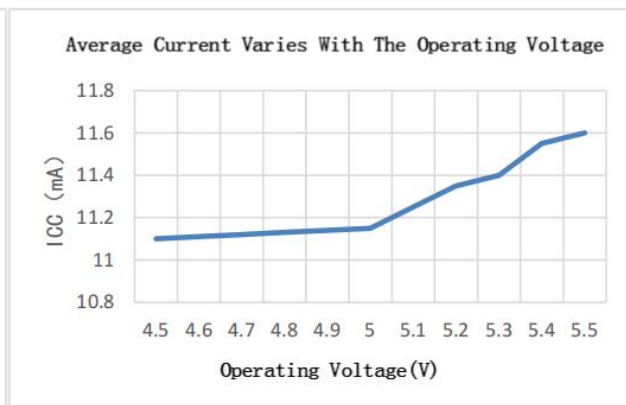
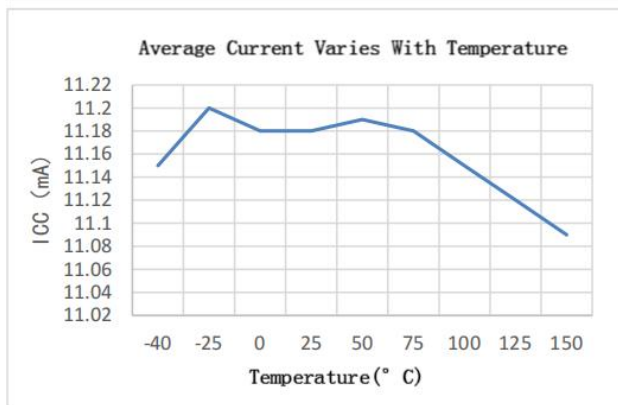

## Typical Application Circuit

The typical application circuit of GT712 includes a filter capacitor  $C_{VCC}$  between  $V_{CC}$  and ground, as well as an optional filter capacitor  $C_{Vout}$  between the output and ground. At the input end of the measured current, pins 1 and 2 are shorted together to serve as the input end of the measured current, while pins 3 and 4 are shorted together to serve as the output end of the measured current. The analog output signal of the sensor is perfectly proportional to the AC/DC current being measured.

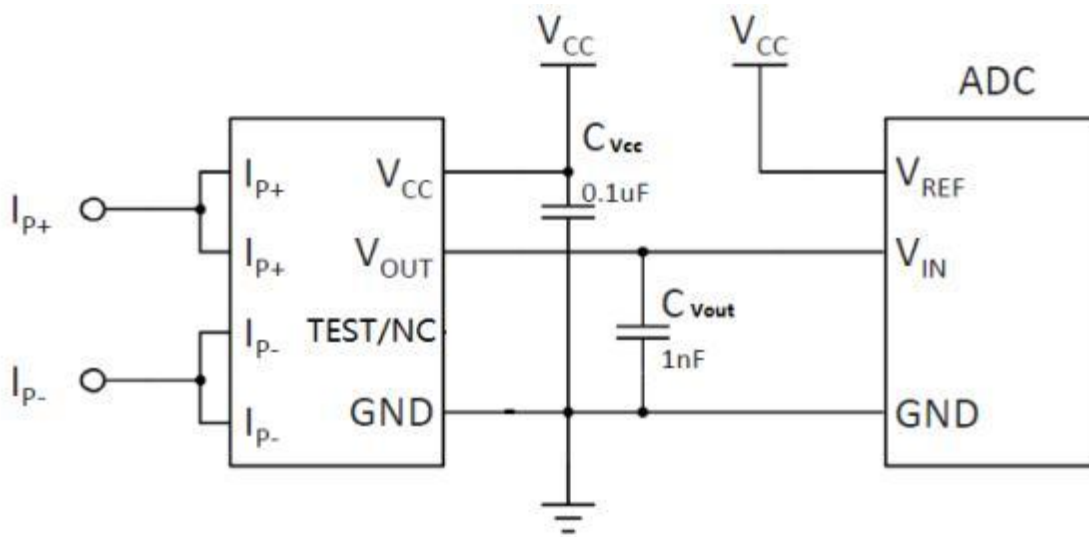

Typical application circuit

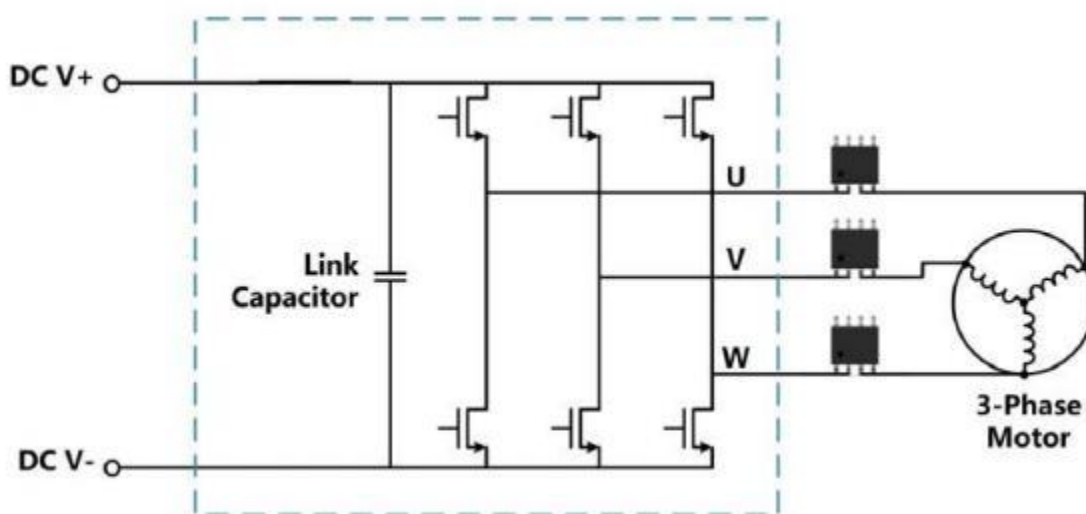

3-Phase Motor Control Application Circuit

## Encapsulate data

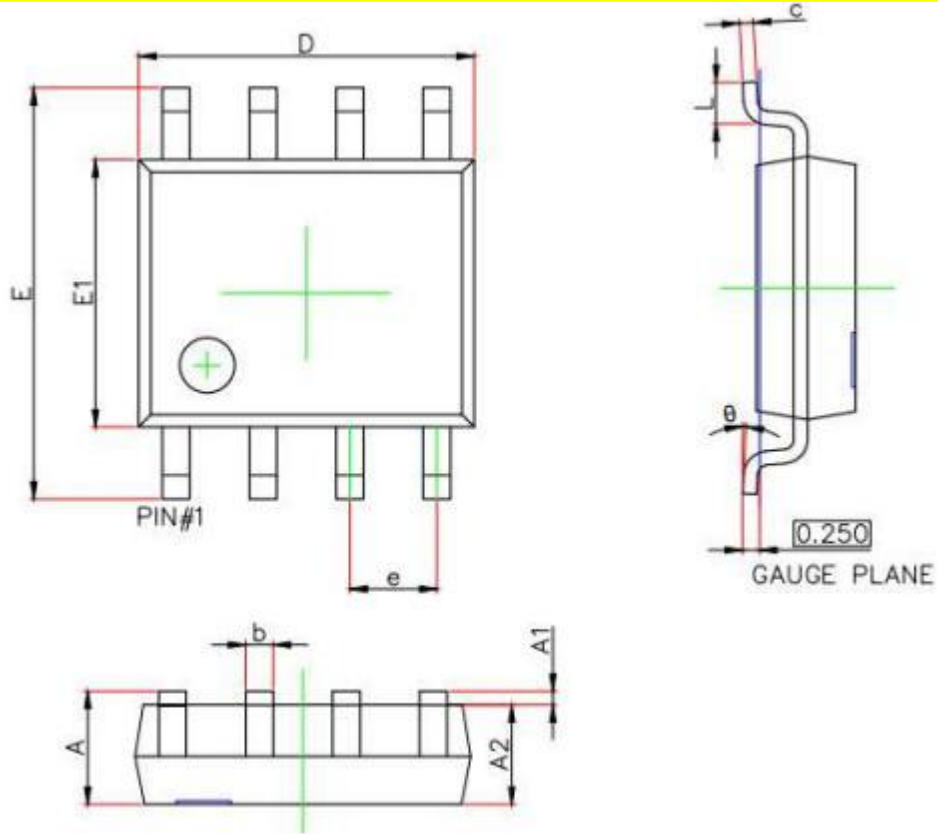

Symbol	Dimensions (mm)		Dimensions (inches)	
	Minimum value	Maximum value	Minimum value	Maximum value
A	1.350	1.750	0.530	0.069
A1	0.100	0.250	0.004	0.010
A2	1.350	1.550	0.053	0.061
b	0.330	0.510	0.013	0.020
c	0.170	0.250	0.007	0.010
D	4.800	5.000	0.189	0.197
e	1.270 (BSC)		0.050 (BSC)	
E	5.800	6.200	0.228	0.224
E1	3.800	4.000	0.150	0.157
L	0.400	1.270	0.016	0.050
θ	0°	8°	0°	8°

## Declaration

- ❖ Shenzhen Xinbole Electronics Co., Ltd. reserves the right to modify the product manual without prior notice! Customers are advised to confirm if the information received is the latest version and verify the completeness of related information before placing an order.
- ❖ Under certain conditions, any semiconductor product may fail or malfunction. It is the buyer's responsibility to comply with safety standards and take appropriate safety measures when designing systems and manufacturing complete machines using products from Shenzhen Xinbole Electronics Co., Ltd. to avoid potential risks of failure that may cause personal injury or property damage.
- ❖ This document is for reference only, and the actual use should be based on the application test results.
- ❖ Product performance improvement is endless. Shenzhen Xinbole Electronics Co., Ltd. will sincerely provide customers with integrated circuit products with better performance and higher quality.

单击下面可查看定价，库存，交付和生命周期等信息

[>>XBLW\(芯伯乐\)](#)