

0603高亮蓝0.6T 贴片式发光二极管

特点 (Characteristics) :

- * 外观尺寸 (L/W/H) 1.6*0.8*0.6mm
Outline Dimensions (L / w / h):1.6x0.8x 0.6 mm
- * 发光颜色及胶体: 蓝光/无色透明
Luminous color and colloid: Blue light/Water Clear
- * 环保工艺符合ROHS要求
Environmental protection products Complied With ROHS Directive
- * EIA规范标准包装
EIA standard packaging
- * 适用于SMT贴片自动化生产
Suitable for SMT automatic production
- * 适用于红外线回流焊制程
Suitable for infrared reflow soldering process



应用领域 (Product application) :

- * 医用设备: 内窥镜、血氧仪
Medical equipment: endoscope、oximeter
- * 汽车电子: 背光按键灯、指示灯
Automotive electronics: backlight key light、indicator light
- * 工业产品: 电子仪表盘、工业设备
Industrial products: electronic instrument panel、industrial equipment
- * 智能家居: 白色家电、数码管LED
Smart home: white appliances, nixie tube LED
- * 通讯产品: 手机按键灯、路由器、电视盒
Communication products: mobile phone button lamp, router



目录

Catalogue

电性参数	
Electrical Characteristics.....	3
典型特性曲线	
Typical Characteristic Curves.....	6
可靠性实验	
Reliability Test Items And Conditions.....	7
外形尺寸	
Outline Dimensions.....	9
包装	
Packaging.....	10
焊接指导	
Guideline for Soldering.....	12
使用注意事项	
Precautions.....	14

电性参数

Electrical Characteristics

光电参数 (Ta=25°C) :Electro-Optical Characteristics (Ta=25°C)

参数 Parameter	符号 Symbol	数据 Data	单位 Unit
		蓝光 Blue	
消耗功率 Power Dissipation	PD	75	MW
最大脉冲电流 Peak Forward Current (1/10占空比, 0.1ms脉宽)	IFP	60	mA
正向直流工作电流 DC Forward Current	IF	20	mA
反向电压 Backward Voltage	VR	9	V
存储环境温度 Storage Temperature Range	Tstg	25°C±5°C	
工作环境温度 Operating Temperature Range	Topr	25°C±5°C	
焊接条件 Soldering Condition	Tsol	回流焊/Reflow soldering : 255°C , 10s max	
		手动焊/Hand soldering : 300°C , 3s max	

极限参数 (Ta=25°C)

Absoiute Maximum Ratings (ta=25 °C)

参数 Parameter	符号 Symbol	数据 Data			单位 Symbol	测试条件 Test Condition
		最小值 Min	平均 Average	最大值 Max		
正向电压 Forward Voltage	Vf	2.6	---	3.0	V	IF=5mA
光强 Light Intensity	Iv	45	---	130	mcd	IF=5mA
主波长 dominant wavelength	λ_d	456	---	476	(nm)	IF=5mA
峰值波长 peak luminous wavelength	λ_p	---	460	---	(nm)	IF=5mA
反向电流 reverse current	Ir	---	---	10	μ A	VR=9V
半光强视角 Half intensity angle of view	2 θ 1/2	---	130	---	Deg	IF=5mA

亮度分档:

Brightness grading

代码 Code	最小值 Min	最大值 Max	单位 unit	测试条件 Test conditions
H03	45	60	mcd	IF=5mA
H04	60	75		
H05	75	90		
H06	90	110		
H07	110	130		
E48	50	65		
E49	65	85		

电压分档:

Voltage grading

代码 Code	最小值 Min	最大值 Max	单位 unit	测试条件 Test conditions
M15	2.6	2.7	V	IF=5mA
M16	2.7	2.8		
M17	2.8	2.9		
M18	2.9	3.0		

波长分档:

Wavelength division

代码 Code	最小值 Min	最大值 Max	单位 unit	测试条件 Test conditions
HB11	456	458	nm	IF=5mA
HB12	458	460		
HB13	460	462		
HB14	462	464		
HB15	464	466		
HB16	466	468		
HB17	468	470		
HB18	470	472		
HB19	472	474		
HB20	474	476		

典型特性曲线

Typical Characteristics Curves

Fig.1 Relative intensity vs. Wavelength

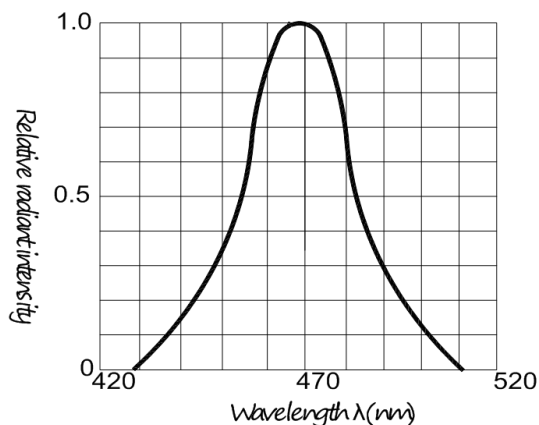

Fig.2 Forward current derating curve vs. Ambient temperature

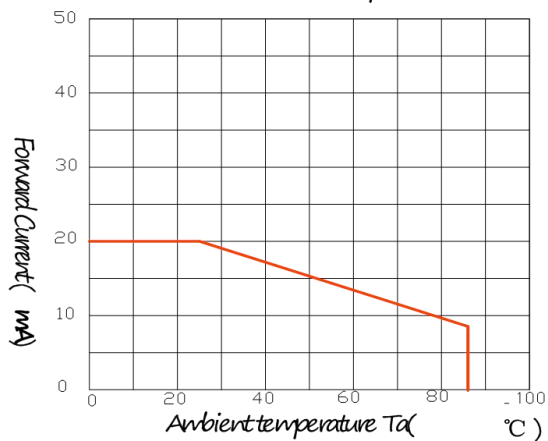

Fig.3 Forward current vs. Forward voltage

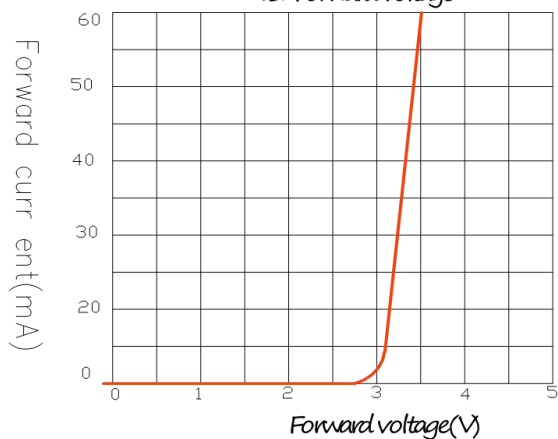

Fig.4 Relative luminous intensity vs. Ambient temperature

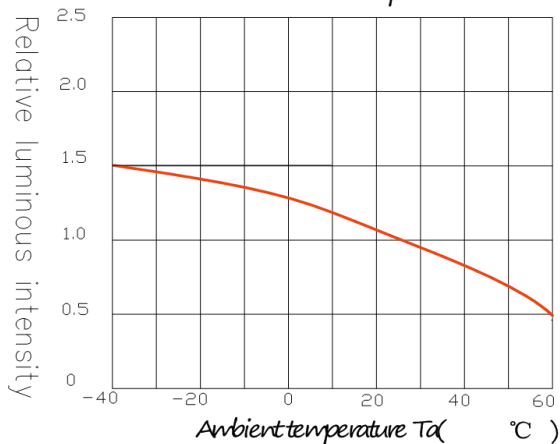

Fig.5 Relative luminous intensity vs. Forward current

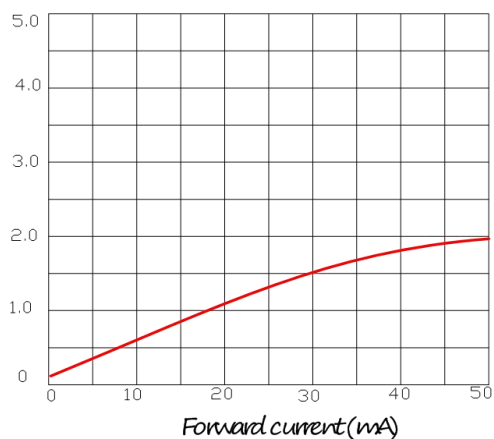
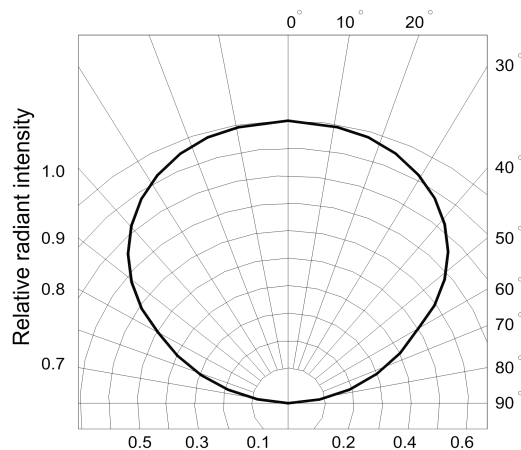

Fig.6 Radiation diagram



可靠性试验

Reliability Test Items And Conditions

类别 Category	测试项目 Test Item	测试环境 The test environment	测试时间 The test of time	参考标准 The reference standard
耐久性测试 Durability test	工作寿命 The working life	室温条件下以最大额定电流持续点亮；以20mA测试。 Continuously lit with maximum rated current at room temperature;Test at 20mA.	1000小时（-24小时，+72小时）	MIL-STD-750D:1026 MIL-STD-883D:1005 JIS C 7021:B-1
	高温高湿储存 High temperature and high humidity storage	IR-Reflow In-Board, 2 Times 环境温度Ta= 85±5℃,相对湿度RH=85±5% Ambient temperature Ta= 85±5℃, relative humidity RH=85±5%	240小时（+24小时）	MIL-STD-202F:103B JIS C 7021:B-11
	高温储存 High temperature storage	环境温度/The environment temperature Ta= 85±5℃	1000小时（-24小时，+72小时）	MIL-STD-883D:1008 JIS C 7021:B-10
	低温储存 Low Temperature Storage	环境温度/The environment temperature Ta= -40±5℃	1000小时（-24小时，+72小时）	JIS C 7021:B-12
	冷热冲击 Cold and hot shock	IR-Reflow In-Board, 2 Times 100± 5℃ ~ -40℃ ± 5℃ 30mins 30mins	50次循环	MIL-STD-202F:107D MIL-STD-750D:1051 MIL-STD-883D:1011
	抗锡试验 Tin test	焊锡温度/Soldering temperature T.sol= 260 ± 5℃	10±1secs2次	MIL-STD-202F:210A MIL-STD-750D:2031 JIS C 7021:A-1

<p>红外回流焊 有铅制程 Infrared reflow welding On a lead</p>	<p>升温速度(183℃到最高值)：最大3℃/秒 维持温度在125(±25)℃：不超过120秒 维持温度在183℃以上：60-150秒 最高温度限制范围：225℃+5/-0℃ 维持在225℃+5/-0℃时间：10-15秒 降温速度：最大6℃/秒 Heating rate (183℃ to maximum) : maximum 3℃/ s Maintain temperature at 125(±25)℃ : not more than 120 seconds Maintain temperature above 183℃ : 60- 150 seconds Maximum temperature limit: 225 ° C +5/-0 ° C Maintain at 225 ° C +5/-0 ° C time: 10-15 seconds Cooling rate: maximum 6℃/ s</p>	<p>-----</p>	<p>MIL-STD- 750D:2031.2 J-STD-020C</p>
<p>红外回流焊 无铅制程 Infrared reflow welding On a lead-free</p>	<p>升温速度(217℃到最高值)：最大3℃/秒 维持温度在175(±25)℃：不超过180秒 维持温度在217℃以上：60-120秒 最高温度限制范围：255℃+0/-5℃ 维持在255℃+0/-5℃时间：5-10秒 降温速度：最大6℃/秒 Heating rate (217℃ to maximum) : maximum 3℃/ s Maintain temperature at 175(±25)℃ : not more than 180 seconds Maintain temperature above 217℃ for 60- 120 seconds Maximum temperature limit: 255℃+0/-5℃ Maintain at 255℃+0/-5℃ time: 5-10 seconds Cooling rate: maximum 6℃/ s</p>	<p>-----</p>	<p>MIL-STD- 750D:2031.2 J-STD-020C</p>
<p>可焊性试验 Weldability test</p>	<p>焊锡温度T.sol= 235 ± 5℃ 浸入速度：25±2.5 mm/秒 上锡率 ≥ 95% 焊盘面积 Solder temperature t.OL = 235 ± 5℃ Immersion speed: 25± 2.5mm/s Tin loading rate ≥ 95% of plate area</p>	<p>浸入时间 Immersion time: 2±0.5 秒</p>	<p>MIL-STD- 202F:208D MIL-STD- 750D:2026 MIL-STD- 883D:2003 IEC 68 Part 2-20 JIS C 7021:A-2</p>

外形尺寸

Outline Dimension

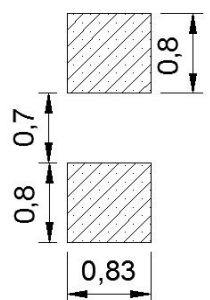
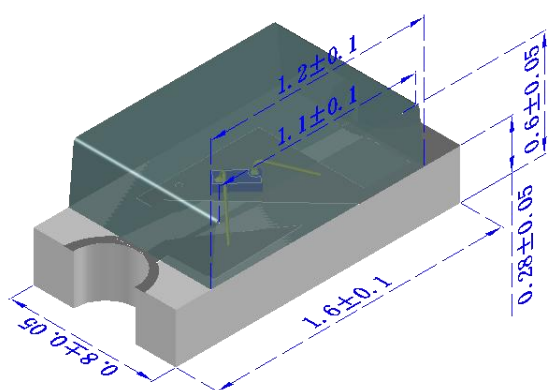

建议焊盘尺寸

0603

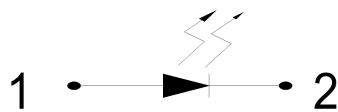
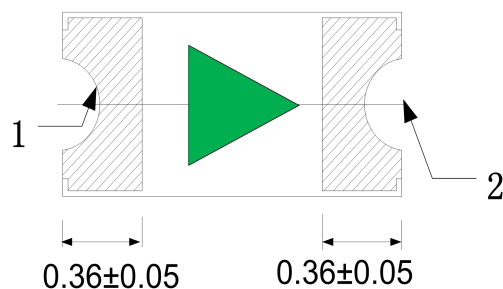

备注: 1. 以上尺寸单位均为mm
Remarks: All dimensions are in millimeters.

2. 未特别标注公差 of 尺寸公差均为 ± 0.25 mm
Tolerance is ± 0.25 mm unless otherwise noted

包装 (1)

Packaging (1)

载带 Carrier Tape

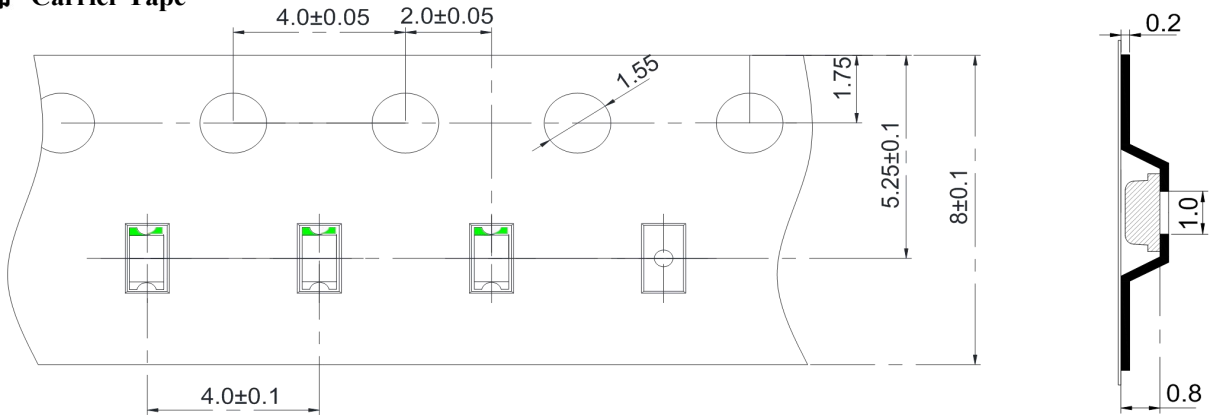

单位: mm, 未注公差: ± 0.1 mm

All dimensions in mm, tolerances unless mentioned is ± 0.1 mm.

❖ 编带细节 Details Of Carrier Tape

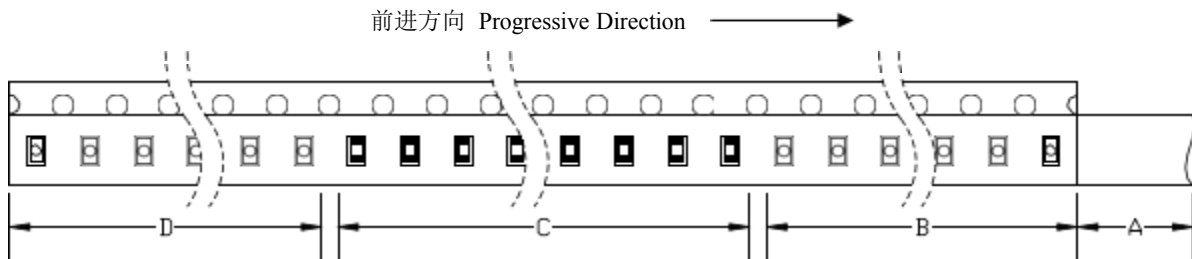

A: 盖带, 300 mm; B: 引导, 空带, 200mm; C: 编载产品 3000 只; D: 尾部, 空带, 200mm

A: Top Cover Tape, 300mm; B: Leader, Empty, 200mm; C: 3000 Lamps Loaded; D: Trailer, Empty, 200mm.

❖ 带盘 Reel Dimension

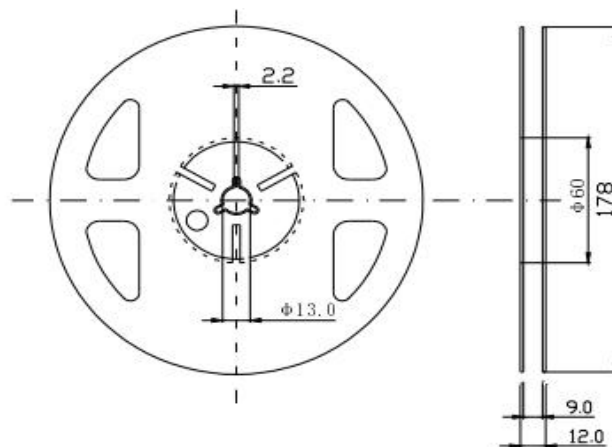

包装 (2)

Packaging (2)

◇ 防潮防静电包装 Moisture Proof and Anti-Electrostatic Foil Bag



◇ 外包装箱 Cardboard Box

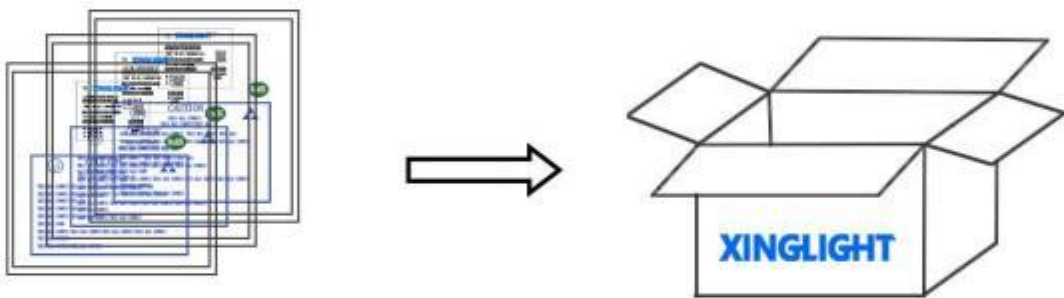

Capacity 5 or 10 reels per box (内箱容量: 50或100卷)

◇ 标签说明: Label Explanation

- LOT NO: 批次信息
- PART NO: 产品型号
- BIN CODE: 产品名称
- WL: 波长范围
- IV: 光强范围
- VF: 电压范围



焊接指导 (1)

Guideline for Soldering (1)

1. 使用烙铁人手焊接

Hand Soldering

推荐使用功率低于 20W 的烙铁, 焊接时烙铁的温度必须保持在 300°C 以下, 且每个电极只能进行一次焊接, 每次焊接的持续时间不得超过 3 秒。

人手焊接过程中的不慎操作易引起 LED 产品的损坏, 应当小心谨慎。

A soldering iron of less than 20W is recommended to be used in Hand Soldering. Please keep the temperature of the soldering iron under 300°C while soldering. Each terminal of the LED is to go for less than 3 second and for one time only.

Be careful because the damage of the product is often started at the time of the hand soldering.

2. 回流焊接: 推荐使用以下无铅回流焊接温度图进行。

Reflow Soldering: Use the conditions shown in the under Figure of Pb-Free Reflow Soldering.

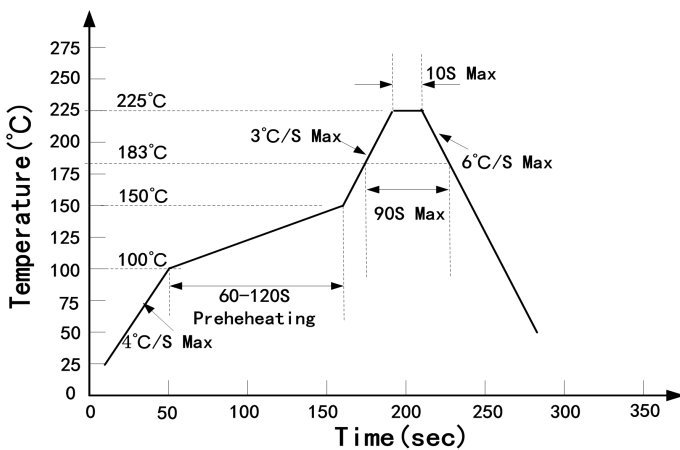

有铅制程Lead process

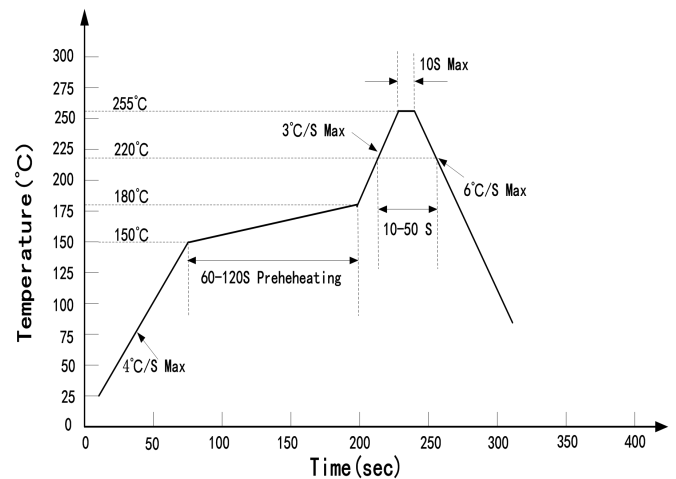

无铅制程lead free

- 回流焊接最多只能进行两次。

Reflow soldering should not be done more than two times.

- 在回流焊接升温过程中, 请不要对 LED 施加任何压力。

Stress on the LEDs should be avoided during heating in soldering process.

- 在焊接完成后, 待产品温度下降到室温之后, 再进行其他处理。

After soldering, do not deal with the product before its temperature drop down to room temperature.

焊接指导 (2)

Guideline for Soldering (2)

3. 清洗:

Cleaning

在焊接后推荐使用酒精进行清洗，在温度不高于 30°C 的条件下持续 3 分钟，不高于 50°C 的条件下持续 30 秒。使用其他类似溶剂清洗前，请先确认使用的溶剂不会对 LED 的封装和环氧树脂部分造成损伤。

超声波清洗也是有效的方法，一般最大功率不应超过 300W，否则可能对 LED 造成损伤。请根据具体的情况预先测试清洗条件是否会对 LED 造成损伤。

It is recommended that alcohol be used as a solvent for cleaning after soldering. Cleaning is to go under 30°C for 3 minutes or 50°C for 30 seconds. When using other solvents, it should be confirmed beforehand whether the solvents will dissolve the package and the resin or not.

Ultrasonic cleaning is also an effective way for cleaning. But the influence of Ultrasonic cleaning on LED depends on factors such as ultrasonic power. Generally, the ultrasonic power should not be higher than 300W. Before cleaning, a pretest should be done to confirm whether any damage to LEDs will occur.

- * **注意:** 此一般指导原则并不适用于所有 PCB 设计和焊接设备的配置。具体工艺受到诸多因素的影响，请根据特定的PCB设计和焊接设备来确定焊接方案。
- * **Note:** This general guideline may not apply to all PCB designs and configurations of all soldering equipment. The technics in practise is influenced by many factors, it should be specialized base on the PCB designs and configurations of the soldering equipment..

使用注意事项（1）

Precautions (1)

1. 贮存:

Storage

- 本产品使用密封防潮抗静电袋包装，并附有干燥剂，未开封的产品有一年的保存时间。

Moisture proof and anti-electrostatic package with moisture absorbent material is used, to keep moisture to a minimum.

- 开封前，产品须存放在温度不高于 30℃，湿度不高于 60%RH 的环境中。

Before opening the package, the product should be kept at 30℃ or less and humidity less than 60% RH, and be used within a year.

- 开封后，产品须存放在温度不高于 30℃，湿度不高于 10%RH 的环境中，且应该在 168 小时（7 天）内使用完。建议工作环境为温度不高于 30℃，湿度不高于 60%RH。

After opening the package, the product should be stored at 30℃ or less and humidity less than 10%RH, and be soldered within 168 hours (7 days). It is recommended that the product be operated at the workshop condition of 30℃ or less and humidity less than 60%RH.

- 对于尚未焊接的 LED，如果吸湿剂或包装失效，或者产品没有符合以上有效存储条件，烘焙可以起到一定的性能恢复效果。烘焙条件：(60±5)℃，持续 24 小时。

If the moisture absorbent material has fade away or the LEDs have exceeded the storage time, baking treatment should be performed based on the following condition: (60±5)℃ for 24 hours.

2. 静电:

Static Electricity

静电和电涌会导致产品特性发生改变，例如正向电压降低等，如果情况严重甚至会损毁产品。所以在使用时必须采

取有效的防静电措施。

所有相关的设备和机器都应该正确接地，同时必须采取其他防止静电和电涌的措施。

使用防静电手环，防静电垫子，防静电工作服、工作鞋、手套，防静电容器，都是有效的防止静电和电涌的措施。

Static electricity or surge voltage damages the LEDs. Damaged LEDs will show some unusual characteristic such as the forward voltage becomes lower, or the LEDs do not light at the low current. even not light.

All devices, equipment and machinery must be properly grounded. At the same time, it is recommended that wrist bands or anti-electrostatic gloves, anti-electrostatic containers be used when dealing with the LEDs.

使用注意事项 (2)

Precautions (2)

3. 设计建议:

Design Consideration

设计电路时，通过 LED 的电流不能超过规定的最大值，同时，还需使用保护电阻，否则，微小的电压变化将会引起较大的电流变化，可能导致产品损毁。

建议使用以下 (A) 电路，该电路能够很好的调节通过每个 LED 的电流；不推荐使用 (B) 电路，该电路在持续的电压驱动下，LED 的正向电压 (V_F) 发生变化，电流会随之而发生变化，可能使某些 LED 承受高于规定的电流值。

In designing a circuit, the current through each LED must not exceed the absolute maximum rating specified for each LED. In the meanwhile, resistors for protection should be applied, otherwise slight voltage shift will cause big current change, burn out may happen.

It is recommended to use Circuit A which regulates the current flowing through each LED rather than Circuit B. When driving LEDs with a constant voltage in Circuit B, the current through the LEDs may vary due to the variation in Forward Voltage (V_F) of the LEDs. In the worst case, some LED may be subjected to stresses in excess of the Absolute Maximum Rating.

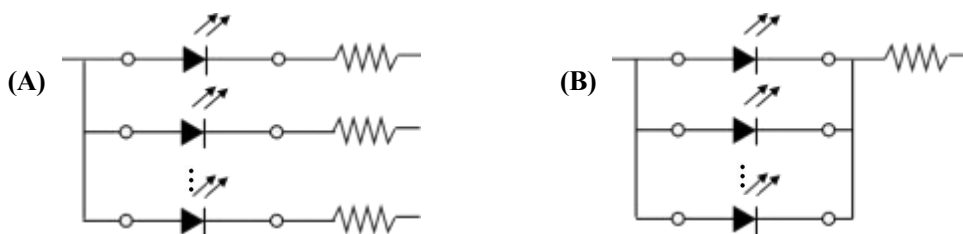

LED 的特性容易因为自身的发热和环境的温度的改变而发生改变。温度的升高会降低 LED 的发光效率、影响发光颜色等，所以在设计时应充分考虑散热的问题。

Thermal Design is paramount importance because heat generation may result in the Characteristics decline, such as brightness decreased, Color changed and so on. Please consider the heat generation of the LEDs when making the system design.

使用注意事项 (3)

Precautions (3)

4. 其他事项:

Others

直接用手拿取产品不但会污染封装树脂表面, 也可能由于静电等因素导致产品性能的改变。过度的压力也可能直接影响封装内部的管芯和金线, 因此请勿对产品施加过度压力, 特别当产品处于高温状态下, 例如在回流焊接过程中。

When handling the product, touching the encapsulant with bare hands will not only contaminate its surface, but also affect on its optical characteristics. Excessive force to the encapsulant might result in catastrophic failure of the LEDs due to die breakage or wire deformation. For this reason, please do not put excessive stress on LEDs, especially when the LEDs are heated such as during Reflow Soldering.



LED 的环氧树脂封装部分相当脆弱, 请勿用坚硬、尖锐的物体刮、擦封装树脂部分。在用镊子夹取的时候也应当小心注意。

The epoxy resin of encapsulant is fragile, so please avoid scratch or friction over the epoxy resin surface. While handling the product with tweezers, do not hold by the epoxy resin, be careful.

5. 眼睛保护忠告:

Safety Advice For Human Eyes

LED 发光时, 请勿直视发光光源, 特别是对于一些光强较高的 LED, 强光可能伤害你的眼睛。

Viewing direct to the light emitting center of the LEDs, especially those of great Luminous Intensity, will cause great hazard to human eyes. Please be careful.

单击下面可查看定价，库存，交付和生命周期等信息

[>>XINGLIGHT\(成兴光\)](#)