

## 0603 黄绿球头贴片式发光二极管



### 特点 (Characteristics) :

- \* 外观尺寸 (L/W/H) :1.6\*0.8\*0.95mm  
Outline Dimensions (L / w / h): 1.6 x 0.8 x 0.95 mm
- \* 发光角度: 35度  
Wide viewing angle : 35°
- \* 发光颜色及胶体: 黄绿色/白色胶体  
Luminous color and colloid: Yellow green / white colloid
- \* 环保工艺符合ROHS要求  
Environmental protection products Complied With ROHS Directive
- \* EIA规范标准包装  
EIA standard packaging
- \* 适用于SMT贴片自动化生产  
Suitable for SMT automatic production
- \* 适用于回流焊制程  
Suitable for reflow soldering process

### 应用领域 (Product application) :

- \* 医用设备: 内窥镜、血氧仪  
Medical equipment: endoscope、oximeter
- \* 汽车电子: 背光按键灯、指示灯  
Automotive electronics: backlight key light、indicator light
- \* 工业产品: 电子仪表盘、工业设备  
Industrial products: electronic instrument panel、industrial equipment
- \* 智能家居: 白色家电、数码管LED  
Smart home: white appliances, nixie tube LED
- \* 通讯产品: 手机按键灯、路由器、电视盒  
Communication products: mobile phone button lamp, router



---

## 目录

---

### Catalogue

<b>电性参数</b>	
Electrical Characteristics.....	3
<b>典型特性曲线</b>	
Typical Characteristic Curves.....	4
<b>可靠性实验</b>	
Reliability Test Items And Conditions.....	5
<b>外形尺寸</b>	
Outline Dimensions.....	6
<b>包装</b>	
Packaging.....	7
<b>焊接指导</b>	
Guideline for Soldering.....	9
<b>使用注意事项</b>	
Precautions.....	11

电性参数

◆Electrical Characteristics

极限参数 (温度=25℃):  
Absolute Maximum Ratings(Temperature=25℃):

参数名称 Parameter	符号 Symbol	最大绝对额定值 Absolute Maximum Rating		单位 Unit
		Yellow	Green	
正向工作电流 Forward working current	IF	25		mA
正向峰值电流 Pulse forward current	IFP	60		mA
功率消耗 Power Dissipation	PD	75		mW
反向电压 Reverse voltage	VR	5		V
储存环境温度 Storage ambient temperature	Tstg	-40℃ To +85℃		℃
工作温度 Operating Temperature	Topr	-40℃ To +85℃		℃
焊接温度 Soldering Temperature	Tslid	Reflow Soldering回流焊接: 245℃		for 10sec.
		Hand Soldering手工焊接: 350℃		for 3sec.

注: 1/10占空比, 0.1ms脉冲宽度。Note: 1/10 Duty Cycle, 0.1ms Pulse Width

光电参数 (温度=25℃):

Electro-Optical Charasteristics (Temperature=25℃):

符号 Symbol	参数 Parameter	装置 Device	最小值 Min	典型值 Typ	最大值 Max	单位 Unit	试验条件 Test Conditions
Iv	发光强度 LuminousIntensity	Yellow Green	70	100	150	mcd	IF=20mA
λD	主导波长 Dominant Wavelength	Yellow Green	566	568	572	nm	IF=20mA
Δλ1/2	发光角度 Viewing Angle	Yellow Green	-	35	-	°	IF=20mA
C	电容 Capacitance	Yellow Green	-	15	-	pF	VF=0V;f=1MHz
VF	正向电压 Forward Voltage	Yellow Green	1.9	2.0	2.2	V	IF=20mA
IR	反向电流 Reverse Curren	Yellow Green	-	-	10	uA	VR = 5V

典型特性曲线

Typical Characteristics Curves

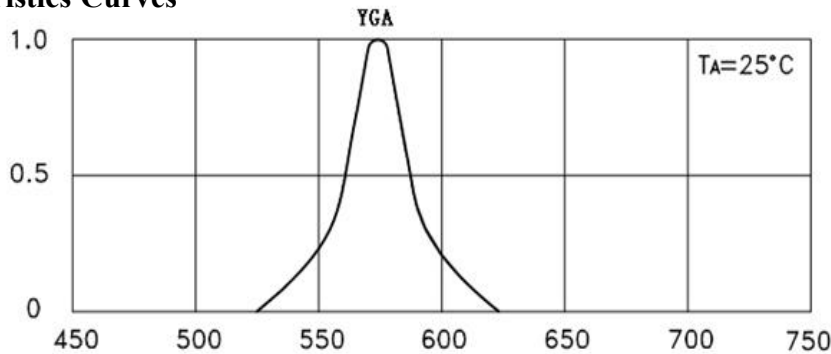

相对亮度与波长之间的关系 Relationship between relative brightness and wavelength

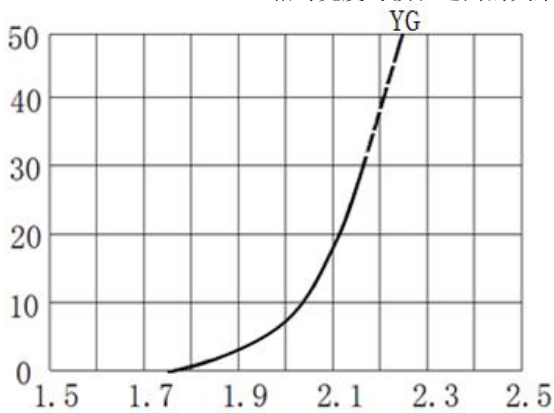

正向电流与正向电压关系曲线图  
Relationship curve between forward current and forward voltage

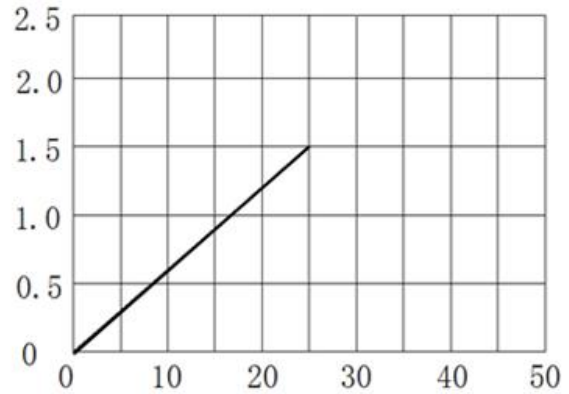

亮度与正向电流关系曲线图  
Relationship between brightness and forward current

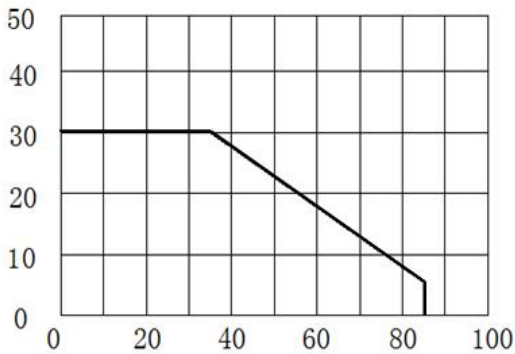

正向电流递减曲线图  
Forward current decline curve

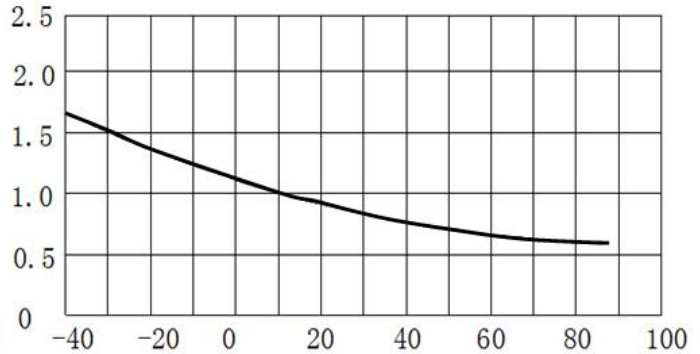

亮度与环境温度关系曲线图  
Relationship curve between brightness and ambient temperature

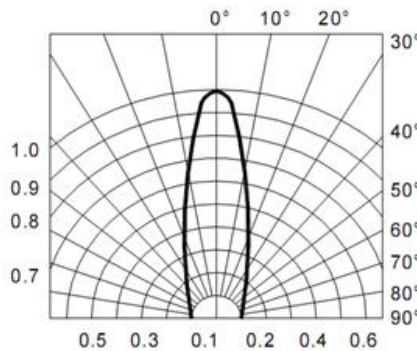

发光角度图解 Luminous angle diagram

## 可靠性试验

### Reliability Test Items And Conditions

序号 Order number	试验项目 Test time	参考标准 Reference standard	试验条件 Condition of experiment	持续时间 Duration	取样数 Sampling number	不良数量 /抽样 Bad quantity/sampling
1	温度循环 Temperature cycle	JEITA ED-4701	-40℃~25℃~100℃~25℃ 30分钟 5分钟 30分钟 5分钟	循环 100 回合Cycle it for 100 rounds	50	0/50
2	冷热冲击 Hot and cold impact	MIL-STD-202G	-40℃~100℃ 15分钟 15分钟	循环 500 回合Cycle it for 500 rounds	50	0/50
3	高温储存 High-temperature storage	JEITA ED-4701 200 201	Ta=100℃	1000 小时 1000hours	50	0/50
4	低温储存 Low temperature storage	JEITA ED-4701 200 201	Ta=-40℃	1000 小时 1000hours	50	0/50
5	常温寿命 试验 Normal temperature life trial	-	Ta=25±5℃ IF=20mA	1000 小时 1000hours	50	0/50
6	高温高湿 试验High temperature and high humidity trial	-	Ta=60℃ RH=85% IF=20mA	1000 小时 1000hours	50	0/50
7	可焊性 (回流焊) Solderability (reflow soldering)	JEITA ED-4701 300 303	Tsol=235℃±5℃,5秒 使用助焊剂 Use solder	焊接一次 , 5秒 Welded once, for 5 seconds	10	0/10
8	耐焊性 (回流焊) Soldering resistance (reflow soldering)	JEITA ED-4701 300 301	Tsol=250℃,10秒 预处理pretreatment: 35℃ 95%RH 96小时	焊接二次 , 每次 10秒 Weleld twice for 10 seconds each	10	0/10

## 外形尺寸

### Outline Dimension

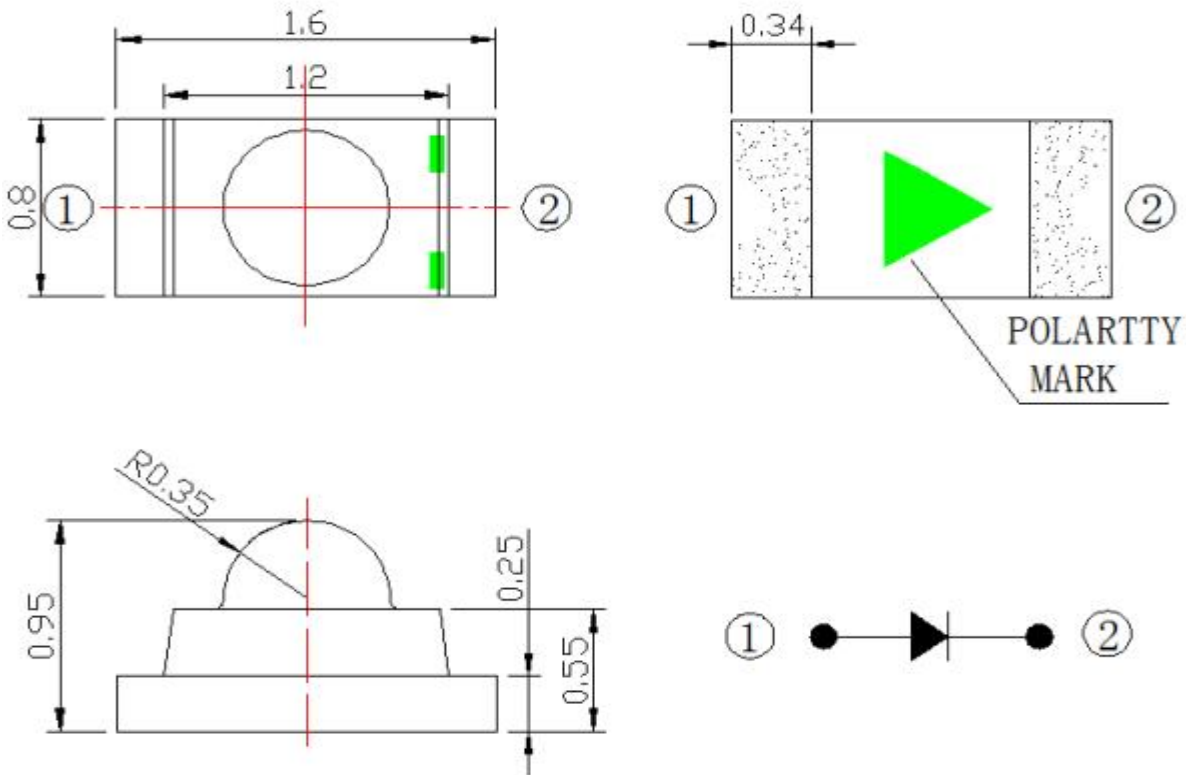

### 推荐焊盘图:

#### Suggest Soldering Pad Dimensions:

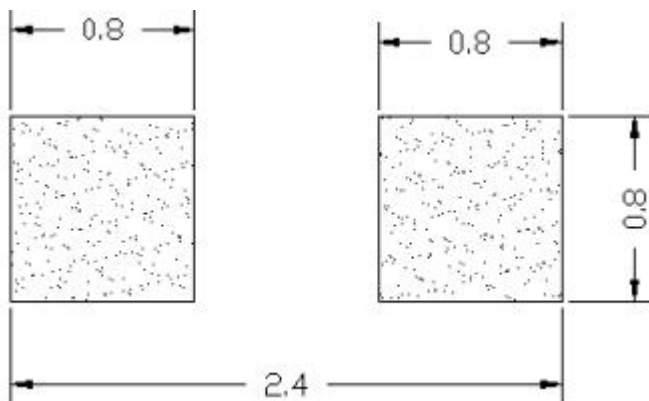

### 备注 (Note) :

1. 单位: mm  
Unit: mm
2. 公差: 如无特别标注则为±0.50mm  
Tolerance: ± 0.50mm unless otherwise specified

## 包装 (1)

### Packaging (1)

编带包装 Fabric with packaging

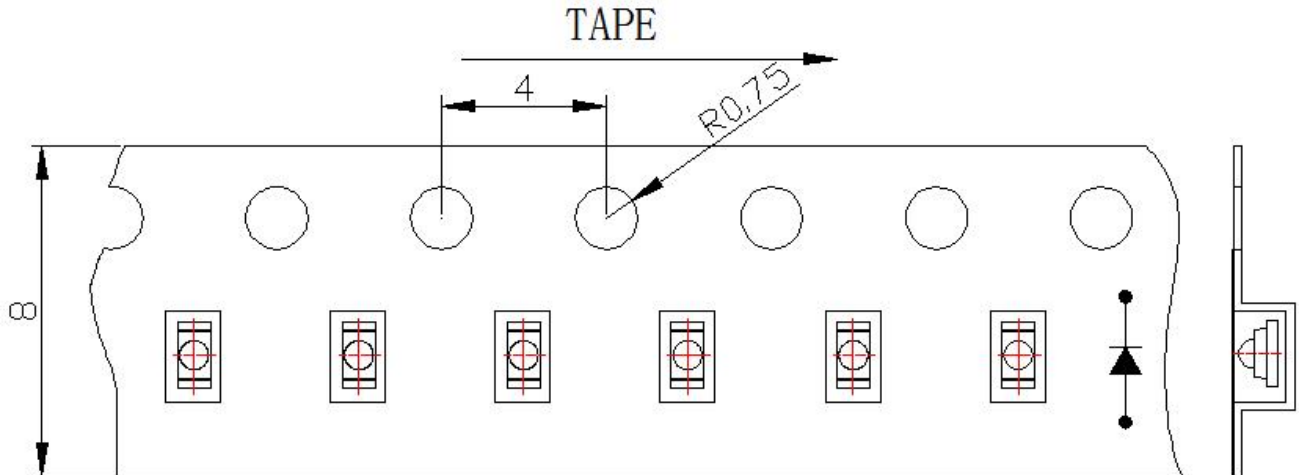

卷轴尺寸 Scroll size

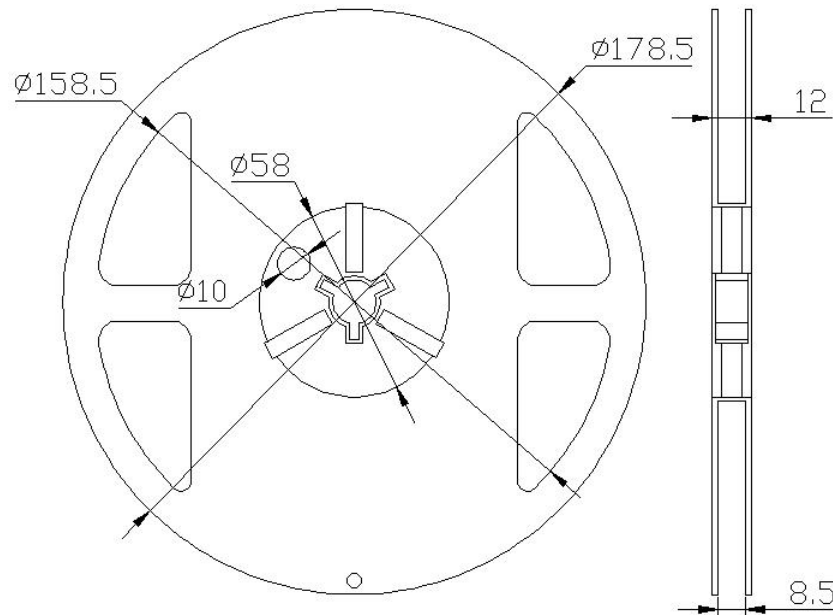

## 包装 (2)

### Packaging (2)

#### ◇ 防潮防静电包装 Moisture Proof and Anti-Electrostatic Foil Bag

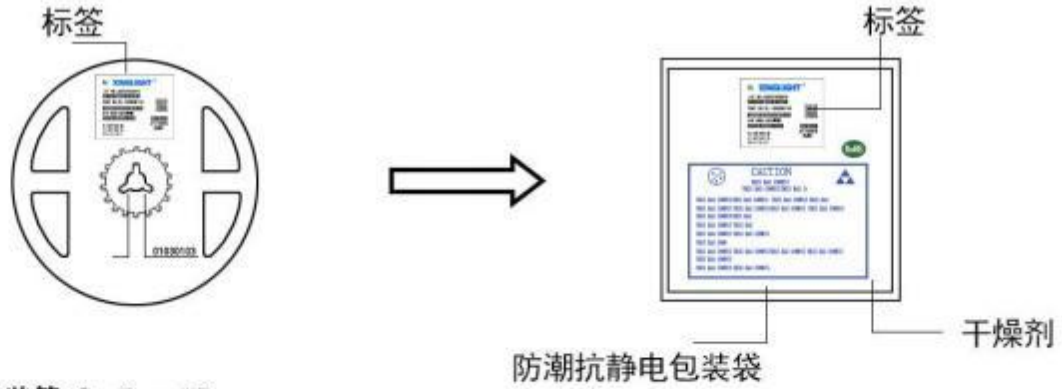

#### ◇ 外包装箱 Cardboard Box

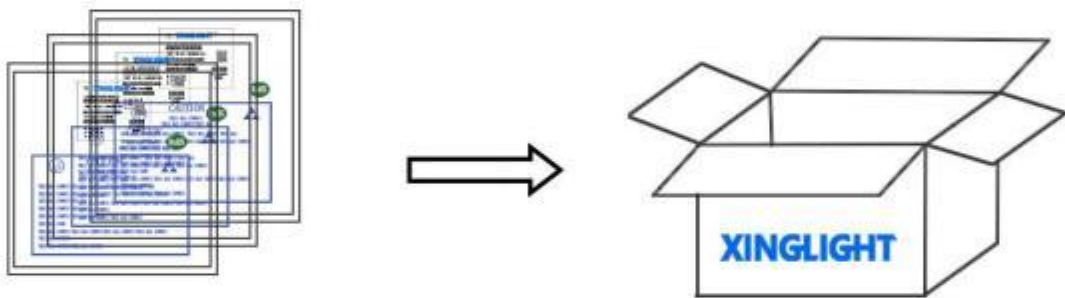

Capacity 5 or 10 reels per box (内箱容量: 50或100卷)

#### ◇ 标签说明: Label Explanation

- LOT NO: 批次信息
- PART NO: 产品型号
- BIN CODE: 产品名称
- WL: 波长范围
- IV: 光强范围
- VF: 电压范围





焊接指导 (1)

Guideline for Soldering (1)

1. 使用烙铁人手焊接

Hand Soldering

推荐使用功率低于 20W 的烙铁, 焊接时烙铁的温度必须保持在 300°C 以下, 且每个电极只能进行一次焊接, 每次焊接的持续时间不得超过 3 秒。

人手焊接过程中的不慎操作易引起 LED 产品的损坏, 应当小心谨慎。

A soldering iron of less than 20W is recommended to be used in Hand Soldering. Please keep the temperature of the soldering iron under 300°C while soldering. Each terminal of the LED is to go for less than 3 second and for one time only.

Be careful because the damage of the product is often started at the time of the hand soldering.

2. 回流焊接: 推荐使用以下无铅回流焊接温度图进行。

Reflow Soldering: Use the conditions shown in the under Figure of Pb-Free Reflow Soldering.

回流焊接Reflow soldering			手工焊接Hand welding	
	有铅 Lead Solder	无铅 Lead-free Solder	温度Temperature	350°C Max.
预热温度Pre-heat	140 ~ 160°C	180 ~ 200°C	焊接时间 Soldering time	3 sec. Max. (onetime only)
预热时间Pre-heat time	120 sec. Max.	120 sec. Max.		
峰值温度Peak temperature	230°C Max.	260°C Max.		
焊接时间Soldering time	10 sec. Max.	10 sec. Max.		
条件Condition	参考下图	参考下图		

有铅回焊 (Lead Solder)

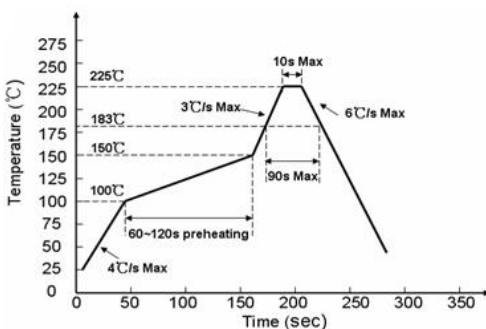

无铅回焊 (Lead-Free Solder)

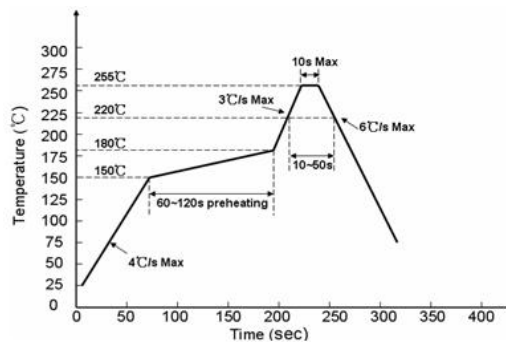

- 回流焊接最多只能进行两次。

Reflow soldering should not be done more than two times.

- 在回流焊接升温过程中, 请不要对 LED 施加任何压力。

Stress on the LEDs should be avoided during heating in soldering process.

- 在焊接完成后, 待产品温度下降到室温之后, 再进行其他处理。

After soldering, do not deal with the product before its temperature drop down to room temperature.

---

## 焊接指导 (2)

---

### Guideline for Soldering (2)

#### 3. 清洗:

##### Cleaning

在焊接后推荐使用酒精进行清洗，在温度不高于 30°C 的条件下持续 3 分钟，不高于 50°C 的条件下持续 30 秒。使用其他类似溶剂清洗前，请先确认使用的溶剂不会对 LED 的封装和环氧树脂部分造成损伤。

超声波清洗也是有效的方法，一般最大功率不应超过 300W，否则可能对 LED 造成损伤。请根据具体的情况预先测试清洗条件是否会对 LED 造成损伤。

It is recommended that alcohol be used as a solvent for cleaning after soldering. Cleaning is to go under 30°C for 3 minutes or 50°C for 30 seconds. When using other solvents, it should be confirmed beforehand whether the solvents will dissolve the package and the resin or not.

Ultrasonic cleaning is also an effective way for cleaning. But the influence of Ultrasonic cleaning on LED depends on factors such as ultrasonic power. Generally, the ultrasonic power should not be higher than 300W. Before cleaning, a pretest should be done to confirm whether any damage to LEDs will occur.

- \* **注意:** 此一般指导原则并不适用于所有 PCB 设计和焊接设备的配置。具体工艺受到诸多因素的影响，请根据特定的PCB设计和焊接设备来确定焊接方案。
- \* **Note:** This general guideline may not apply to all PCB designs and configurations of all soldering equipment. The technics in practise is influenced by many factors, it should be specialized base on the PCB designs and configurations of the soldering equipment..

## 使用注意事项（1）

### Precautions (1)

#### 1. 贮存:

##### Storage

- 本产品使用密封防潮抗静电袋包装，并附有干燥剂，未开封的产品有一年的保存时间。

Moisture proof and anti-electrostatic package with moisture absorbent material is used, to keep moisture to a minimum.

- 开封前，产品须存放在温度不高于 30℃，湿度不高于 60%RH 的环境中。

Before opening the package, the product should be kept at 30℃ or less and humidity less than 60% RH, and be used within a year.

- 开封后，产品须存放在温度不高于 30℃，湿度不高于 10%RH 的环境中，且应该在 168 小时（7 天）内使用完。建议工作环境为温度不高于 30℃，湿度不高于 60%RH。

After opening the package, the product should be stored at 30℃ or less and humidity less than 10%RH, and be soldered within 168 hours (7 days). It is recommended that the product be operated at the workshop condition of 30℃ or less and humidity less than 60%RH.

- 对于尚未焊接的 LED，如果吸湿剂或包装失效，或者产品没有符合以上有效存储条件，烘焙可以起到一定的性能恢复效果。烘焙条件：(60±5)℃，持续 24 小时。

If the moisture absorbent material has fade away or the LEDs have exceeded the storage time, baking treatment should be performed based on the following condition: (60±5)℃ for 24 hours.

#### 2. 静电:

##### Static Electricity

静电和电涌会导致产品特性发生改变，例如正向电压降低等，如果情况严重甚至会损毁产品。所以在使用时必须采取有效的防静电措施。

所有相关的设备和机器都应该正确接地，同时必须采取其他防止静电和电涌的措施。

使用防静电手环，防静电垫子，防静电工作服、工作鞋、手套，防静电容器，都是有效的防止静电和电涌的措施。

Static electricity or surge voltage damages the LEDs. Damaged LEDs will show some unusual characteristic such as the forward voltage becomes lower, or the LEDs do not light at the low current. even not light.

All devices, equipment and machinery must be properly grounded. At the same time, it is recommended that wrist bands or anti-electrostatic gloves, anti-electrostatic containers be used when dealing with the LEDs.

## 使用注意事项 (2)

### Precautions (2)

#### 3. 设计建议:

##### Design Consideration

设计电路时，通过 LED 的电流不能超过规定的最大值，同时，还需使用保护电阻，否则，微小的电压变化将会引起较大的电流变化，可能导致产品损毁。

建议使用以下 (A) 电路，该电路能够很好的调节通过每个 LED 的电流；不推荐使用 (B) 电路，该电路在持续的电压驱动下，LED 的正向电压 ( $V_F$ ) 发生变化，电流会随之而发生变化，可能使某些 LED 承受高于规定的电流值。

In designing a circuit, the current through each LED must not exceed the absolute maximum rating specified for each LED. In the meanwhile, resistors for protection should be applied, otherwise slight voltage shift will cause big current change, burn out may happen.

It is recommended to use Circuit A which regulates the current flowing through each LED rather than Circuit B. When driving LEDs with a constant voltage in Circuit B, the current through the LEDs may vary due to the variation in Forward Voltage ( $V_F$ ) of the LEDs. In the worst case, some LED may be subjected to stresses in excess of the Absolute Maximum Rating.

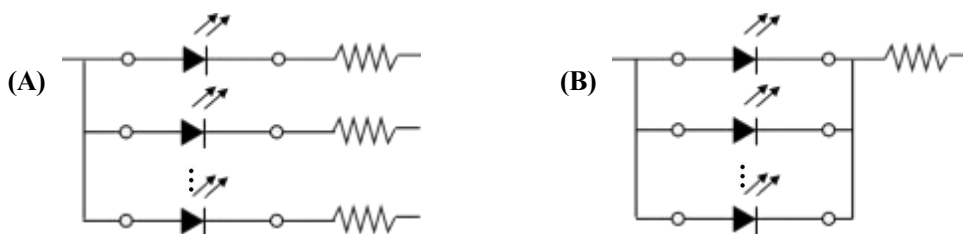

LED 的特性容易因为自身的发热和环境的温度的改变而发生改变。温度的升高会降低 LED 的发光效率、影响发光颜色等，所以在设计时应充分考虑散热的问题。

Thermal Design is paramount importance because heat generation may result in the Characteristics decline, such as brightness decreased, Color changed and so on. Please consider the heat generation of the LEDs when making the system design.

## 使用注意事项 (3)

### Precautions (3)

#### 4. 其他事项:

##### Others

直接用手拿取产品不但会污染封装树脂表面, 也可能由于静电等因素导致产品性能的改变。过度的压力也可能直接影响封装内部的管芯和金线, 因此请勿对产品施加过度压力, 特别当产品处于高温状态下, 例如在回流焊接过程中。

When handling the product, touching the encapsulant with bare hands will not only contaminate its surface, but also affect on its optical characteristics. Excessive force to the encapsulant might result in catastrophic failure of the LEDs due to die breakage or wire deformation. For this reason, please do not put excessive stress on LEDs, especially when the LEDs are heated such as during Reflow Soldering.

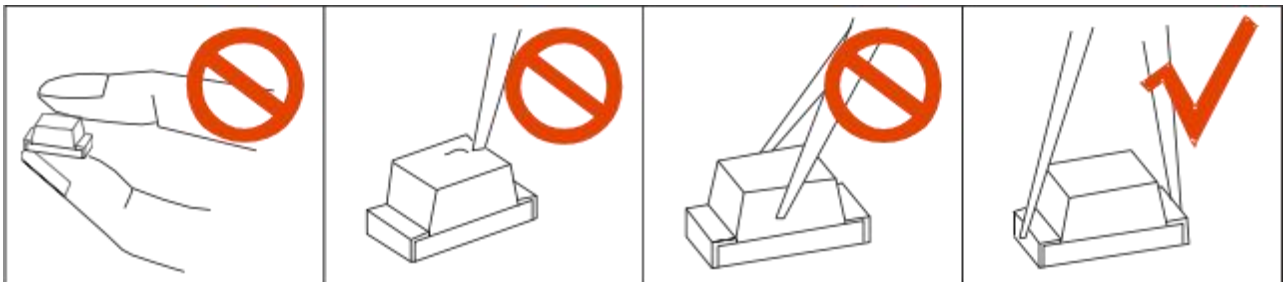

LED 的环氧树脂封装部分相当脆弱, 请勿用坚硬、尖锐的物体刮、擦封装树脂部分。在用镊子夹取的时候也应当小心注意。

The epoxy resin of encapsulant is fragile, so please avoid scratch or friction over the epoxy resin surface. While handling the product with tweezers, do not hold by the epoxy resin, be careful.

#### 5. 眼睛保护忠告:

##### Safety Advice For Human Eyes

LED 发光时, 请勿直视发光光源, 特别是对于一些光强较高的 LED, 强光可能伤害你的眼睛。

Viewing direct to the light emitting center of the LEDs, especially those of great Luminous Intensity, will cause great hazard to human eyes. Please be careful.

单击下面可查看定价，库存，交付和生命周期等信息

[>>XINGLIGHT\(成兴光\)](#)