

外形图 Package Dimensions:

- * 发光颜色及胶体: 高亮度红普绿双色/无色雾状胶体
- * Luminous color and colloid: high brightness red and yellow green / colorless fog colloid
- * 外观尺寸: 5mm/5.8*8.7*5.08
- Appearance dimension:5mm/5.8*8.7*5.08
- * 环保产品, 符合ROHS要求
- Environmentally friendly products, meeting ROHS requiremen



应用 Applications:

- * 3C产品（通讯和消费电子）的指示灯和背光源
- * Indicator light and backlight of 3C products (communication and consumer elect ronics)



目录

Catalogue

电性参数
Electrical Characteristics..... 3

外形尺寸
Outline Dimensions..... 5

包装
Packaging..... 6

使用注意事项
Precautions..... 7

电性参数

Electrical Characteristics

极限参数 (Absolute Maximum Ratings) (Ta=25°C)

参数 (Parameter)	符号 (Symbol)	最大额定值 (Maximum rating)		单位 (Unit)
晶片品种 Chip variety		红光 (Red light)	普绿 (Common green)	
消耗功率 Power consumption	Pd	80	100	mW
最大脉冲电流 Maximum pulse current	IFP	20	20	mA
正向直流工作电流 Forward DC working current	IF	40	40	mA
反向电压 Reverse voltage	VR	6	6	V
焊接温度/时间 Lead Soldering Temperature/Time	Tsol	240/≤3	240/≤3	°C/S
工作环境温度 Operating ambient temperature	Topr	-25~+85	-25~+85	°C

光电参数 (Initial Electrical Optical Characteristics) (Ta=25°C)

晶片种类 (Chip type)		红光晶片 (Red light chip)			普绿晶片 (Common green chip)			单位 Unit	测试条件 Unit
项目参数 Project parameters	符号 Symbol	最小值 Minimum value	一般值 General value	最大值 Maximum	最小值 Minimum value	一般值 General value	最大值 Maximum		
发光强度 Luminous intensity	IV	500	/	700	450	/	650	mcd	IF=20mA
发光角度 Luminous angle	2Ø1/2	/	45	/	/	45	/	deg	IF=20mA
峰值波长 Peak wavelength	λp	/	638	/	/	570	/	nm	IF=20mA
主波长 Dominant wavelength	λd	635	/	640	560	/	580	nm	IF=20mA
频宽 Bandwidth	Δλ	/	30	/	/	30	/	nm	IF=20mA
正向电压 Forward voltage	VF	1.9	/	2.3	2.0	/	2.4	V	IF=20mA
反向电流 Reverse current	IR	/	/	≤30	/	/	≤30	μA	VR=5V

注：本公司所提供的LED产品可根据客户需求订做，相关技术参数会发生变化，详细情况请咨询我公司有关人员。

经老化实验证明：本LED在正常工作条件下：即 $I_F=20\text{mA}$ 、 $V_F=2.5\text{V}$ 时，使用寿命为3——5万小时。

Note:

The LED products provided by the company can be ordered according to customer needs, and the relevant technical parameters will change, please consult our relevant personnel for details.

The aging experiment has proved that the service life of the LED, when $I_F=20\text{mA}$ and $V_F=2.5\text{V}$, is 3 —— and 50,000 hours.

外形尺寸

Outline Dimension

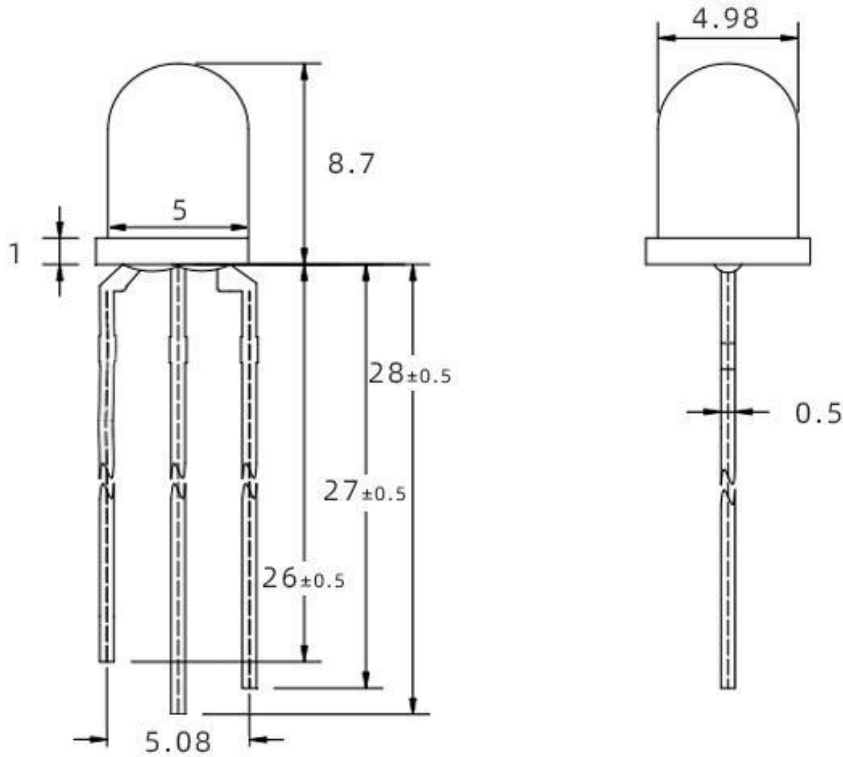
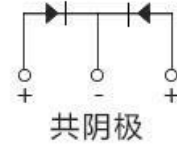
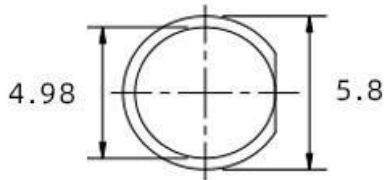

备注 (Note):

1. 标注尺寸单位为毫米

Dimensions are in millimeters.

2. 除特别标注外, 所有尺寸允许公差± 0.1mm .

Tolerances unless mentioned are ± 0.1mm.

包装

Packaging

*袋装

In Bags

*防潮抗静电包装

Moisture Proof and Anti-Electrostatic Foil Bag

◇ 标签说明: Label Explantion

LOT NO: 批次信息

PART NO: 产品型号

BIN CODE: 产品名称

WL: 波长范围

IV: 光强范围

VF: 电压范围



使用注意事项 (1)

Precautions (1)

1. 应用 APPLY

此LED可使用于一些普通的电子设备，例如办公设备，通信设备、房屋装饰，若LED用在一些可靠性要求较高的情况下，如航空运输，交通控制及医辽器械时，一定需参考销售提供之资料进行使用。

This LED can be used in some ordinary electronic equipment, such as office equipment, communication equipment, house decoration, if LED is used in some high reliability requirements, such as air transportation, traffic control and medical liao equipment, must refer to the information provided by sales.

2. 储存 Keep in storage

贮存LED的环境，温度不超过30℃，相对湿度不超过70%。建议LED在原包装箱里日期不超过三个月 进行使用，如果需加长贮存时间，建议放在干燥箱内，并加放干燥剂， 或者充入氮气。

Storage environment of LED with temperature not exceeding 30℃ and relative humidity not exceeding 70%.It is recommended that LDE be used in the original box for no more than three months. If longer storage time is required, put it in the drying box and add desiccant or filled with nitrogen.

3. 清洗 Clean

当用化学品清洗胶体时必须特别小心，因为有些化学品对胶体表面有损伤并引起褪色如三氯乙烯、丙、酮等。可用乙醇擦拭、浸渍，时间在常温下不超过3分钟。

Special care must be taken when cleaning colloids with chemicals, as some chemicals have damage to the colloidal surface and cause fading such as trichloroethylene, propylene, ketone, etc.It can be wiped and soaked with ethanol for no more than 3 minutes at room temperature.

4. 引脚配置 Feet assembly

(1) 必需离胶体2毫米才能折弯支架。

It must be 2 mm from the colloid to bend the bracket.

(2) 支架成形必须用夹具或由专业人员来完成。

Support forming must be done with fixtures or by a professional.

(3) 支架成形必须在焊接前完成。

Support forming must be completed before welding.

(4) 支架成形需保证引脚和间距与线路板上一致。

The pins and spacing are the same as on the circuit board.

(5) 焊接必须在正常温度下进行，当LED正常焊接到PCB板上后，应尽量避免在LED引脚处施加机械压力。

Welding must be performed at normal temperature and when LED is normally welded to the PCB plate, avoid applying mechanical pressure at LED pins at a minimum.

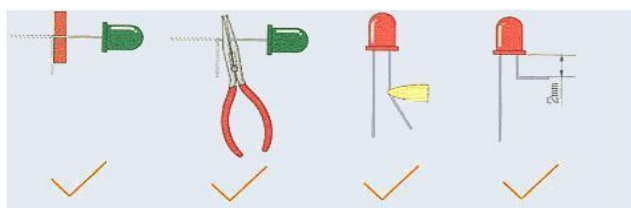

使用注意事项 (2)

Precautions (2)

5. 焊接 Weld

当焊接时，必需在胶体底部2mm以下进行焊接，在焊接时，应尽力避免浸渍LED胶体，在刚焊接完后，应避免在引脚上加外力或者摇动LED胶体。

When welding, welding must be conducted below 2mm of colloid bottom. When welding, try to avoid soaking LED colloid. After welding, avoid adding external force on the pin or shaking LED colloid.

推荐的焊接条件

烙铁焊接		波峰焊	
温度	260°C Max	Pre-heat	100°C Max
焊接时间	5 sec.Max	Pre-heat time	60sec.Max
	(one time only)	Solder wave	260°C Max
		Soldering time	10sec.Max

过高的焊接温度和长时间的焊接会导致LED变形和失效

Excessive welding temperature and prolonged welding can lead to LED deformation and failure.

6. 驱动方式 Drive way

LED的当前驱动方式，若LED为多颗并联时，建议采用线路A，在每颗LED，处加一限流电阻，以保证LED之亮度一致。

In the current driving mode of LED, if LED is multiple in parallel, it is recommended to use line A and add a flow limit resistance to each LED to ensure the consistent brightness of LED.

Circuit model A

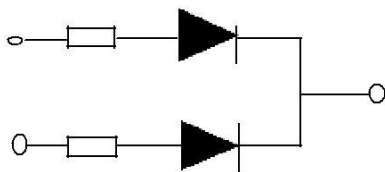

Circuit model B

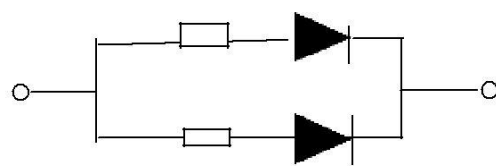

7. 静电防护 Electrostatic protection

静电和电流的急剧升高将会对LED产生损害，InGaN系列产品使用时请使用防静电装置，如防护带和手套注意：使用时人体放电模式HBM<1000V；机器放电模式<100V。

High increase of static electricity and current will damage LED. Use antistatic devices such as protective belts and gloves.

Note: human discharge mode HBM <1000V; machine discharge mode <100V.

使用注意事项 (3)

Precautions (3)

8.其他事项 Others

直接用手拿取产品不但会污染封装树脂表面，也可能由于静电等因素导致产品性能的改变。过度的压力也可能直接影响封装内部的管芯和金线，因此请勿对产品施加过度压力，特别当产品处于高温状态下，例如在回流焊接过程中。

When handling the product, touching the encapsulant with bare hands will not only contaminate its surface, but also affect on its optical characteristics. Excessive force to the encapsulant might result in catastrophic failure of the LEDs due to die breakage or wire deformation. For this reason, please do not put excessive stress on LEDs, especially when the LEDs are heated such as during Reflow Soldering.

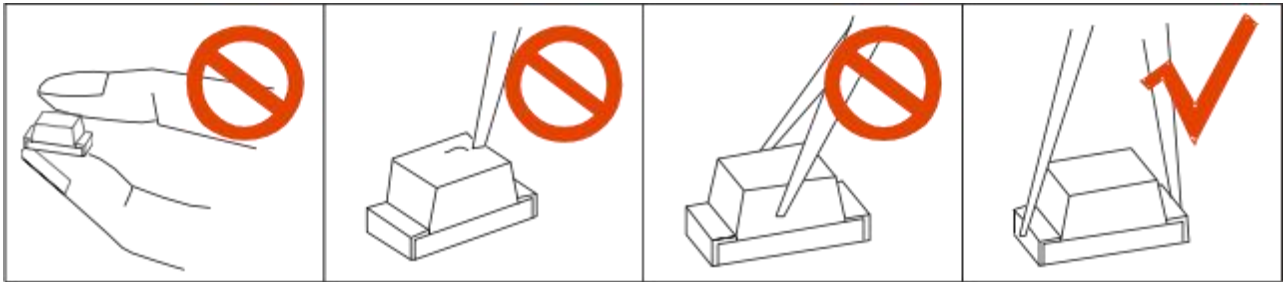

LED 的环氧树脂封装部分相当脆弱，请勿用坚硬、尖锐的物体刮、擦封装树脂部分。在用镊子夹取的时候也应当小心注意。

The epoxy resin of encapsulant is fragile, so please avoid scratch or friction over the epoxy resin surface. While handling the product with tweezers, do not hold by the epoxy resin, be careful.

9.眼睛保护忠告 Safety Advice For Human Eyes

LED 发光时，请勿直视发光光源，特别是对于一些光强较高的LED，强光可能伤害你的眼睛。

Viewing direct to the light emitting center of the LEDs, especially those of great Luminous Intensity, will cause great hazard to human eyes. Please be careful.

单击下面可查看定价，库存，交付和生命周期等信息

[>>XINGLIGHT\(成兴光\)](#)