

SPECIFICATIONS:

- INSULATION RESISTANCE: VOLTAGE OF 500V D.C. SHALL BE APPLIED TO THE TERMINALS, AFTER WHICH MEASUREMENT SHALL BE MADE. A GAUGE FOR THE MEASUREMENT SHALL BE USED. THE INSULATED GAUGE.
- CONTACT RESISTANCE: 30mΩ OR LESS
- VOLTAGE PROOF: 500V AC FOR ONE MINUTE
- DURABILITY: 10,000 INSERTION/REMOVAL CYCLES (MINIMUM)
- INSERTION FORCE: 0.4KGF~2.0KGF
- WITHDRAWAL FORCE: 0.4KGF~2.0KGF
- WATER PROOFNESS: THIS PRODUCT IS CONFORM TO JIS STANDARD IPX7 BY WATERPROOF JACK
- USING PLUG: φ3.5MM, 4-POLE STEREO EARTHONE(LCH/RCH/SND/MIC)
- PROVIDED THAT THEY CONFORM TO JIS C6560
- 9-0-RING ASSEMBLY AREA TO MAINTAIN SMOOTH, SHALL HAVE NO BURRS

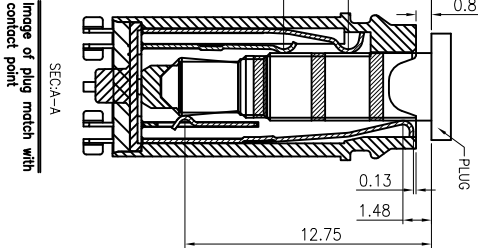
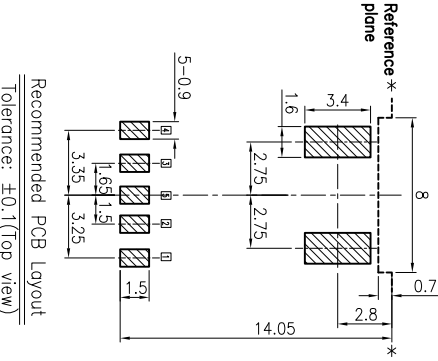
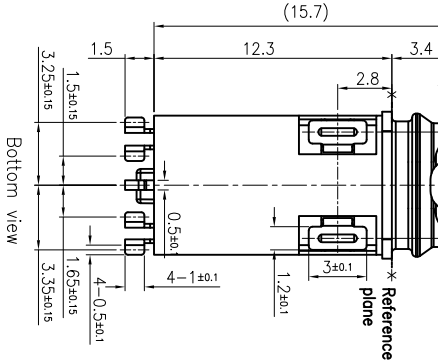
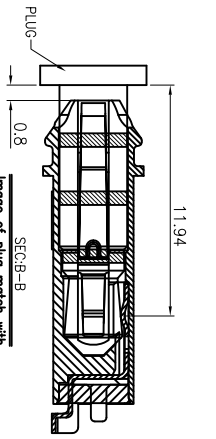
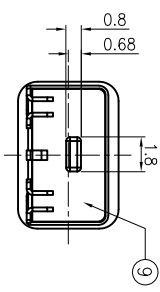
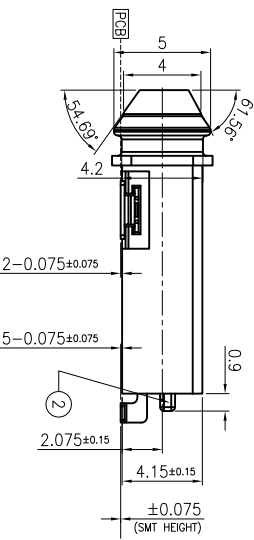
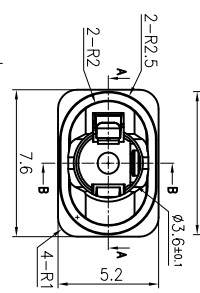

UNLESS OTHERWISE SPECIFIED, TOLERANCE ON DECIMAL: ±0.2

AX		ANGULAR	±5°
AX		X.X	±0.2mm
AX		X.XX	±0.1mm
AX		X.XXX	±0.05mm
MARK			
REVISIONS			
	DESCRIPTION	DATE	REVISED
UNSPECIFIED TOLERANCES			
DSND	DATE	SCALE: N/A	MODEL TYPE: 3.5 PHONE JACK
DWN	DATE	VIEW: 3/4	PART NO.: PJ-3255A
CHKD	DATE	UNIT: mm	DWG NO.: PJ-3255A
APPD	DATE	SIZE: A4	WEIGHT 1.0g
XKB INDUSTRIAL PRECISION CO., LIMITED		SHEET 1/1	REVISION A0

ITEM	PART NAME	TERMINAL	QTY	MATERIAL	REMARK
①	HOUSING	---	1	PAG7(BLACK)	UL 94V-0
②	COVER	---	1	PAG7(BLACK)	UL 94V-0
③	EARTH SPRING	1	1	Ti-Cu t=0.2	1±0.02
④	TIP SPRING-1	1	1	Ti-Cu t=0.2	1±0.02
⑤	RING SPRING-1	1	1	Ti-Cu t=0.2	1±0.02
⑥	RING SPRING-2	1	1	Ti-Cu t=0.2	1±0.02
⑦	TIP SPRING-2	1	1	Ti-Cu t=0.2	1±0.02
⑧	TERMINAL	---	2	C2680 t=0.2	1±0.02
⑨	BOND	---	1	---	---

IP-X7

单击下面可查看定价，库存，交付和生命周期等信息

[>>XKB Connectivity\(中国星坤\)](#)