

MODEL NO.:

- (1) Series no.
- (2) Schematic type: A,B,C
- (3) Housing color:  
BK7=Black
- (4) Terminal plating:  
AU03=Plating AU 3u" min.
- (5) Packing mode:L=Reel packing
- (6) Environmental requirements:  
Rh=RoHS 2.0 + Halogen Free

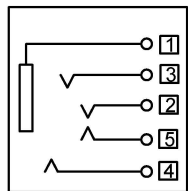

Circuit Diagram

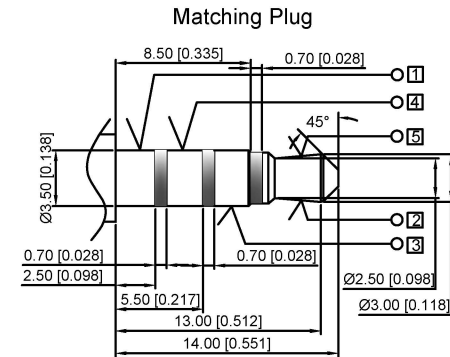
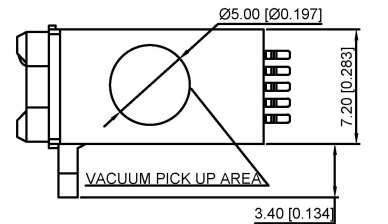
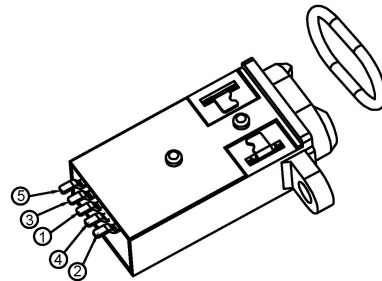
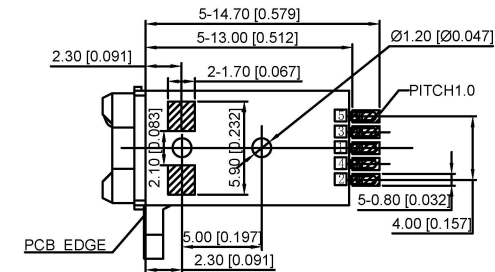
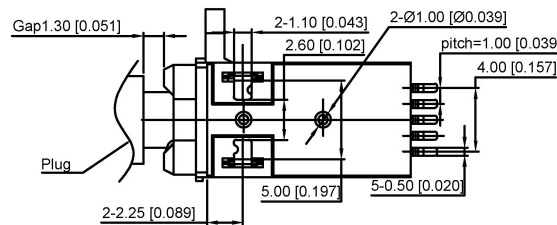
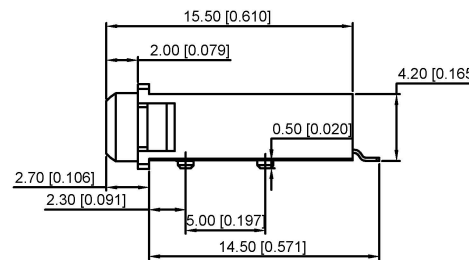
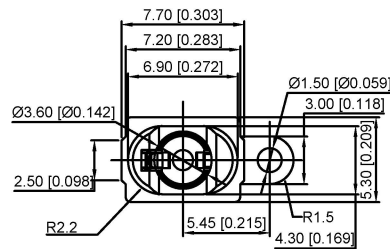

RECOMMENDED P.C.B LAYOUT  
TOP VIEW (TOLRANCE:±0.05)

SPECIFICATION:

- 1.Electrical characteristics
  - 1-1.Current rating:DC 0.5A max.
  - 1-2.Voltage rating:DC 30V.
  - 1-3.Contact resistance:50mΩ max
  - 1-4.Insulation resistance:1000MΩ min. at 500V DC.
  - 1-5.Withstanding voltage:500V AC for 1 minute.
- 2.Mechanical characteristics
  - 2-1.Life test:5000 cycles min,
  - 2-2.Mating force:3~30N,  
Unmating force:3~30N.
- 3.Temperature range: -40°C~+80°C
- 4.Dustproof and waterproof grade: IP67

广东星坤科技股份有限公司

生	日期
效	日期

MARK	DESCRIPTION	DATE	REVISED	APPROVED	REVISIONS
					UNSPECIFIED TOLERANCES

DSND		DATE	SCALE: N/A	MODEL TYPE: 3.5 PHONE JACK
DWN		DATE	VIEW:	PART NO.:
CHKD		DATE	UNIT: mm/in	DWG NO.: PJ-3254
APPD		DATE	SIZE: A4	WEIGHT
XKB INDUSTRIAL PRECISION CO., LIMITED				SHEET
				REVISION
				1.0g
				1/1
				A0

单击下面可查看定价，库存，交付和生命周期等信息

[>>XKB Connectivity\(中国星坤\)](#)