

SECT B-B

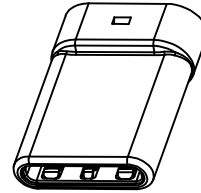

P/N	R/C
U261-24XXN-4B0281	C(10nF/30V MIN)
U261-24XXN-4B0165	C(10nF/30V MIN)+RD(5.1KΩ)
U261-24XXN-4B0174	C(10nF/30V MIN)+RP(56KΩ)

U261-24XXN-4B0281

C TYPE PLUG:

PCB:

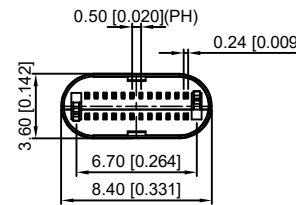
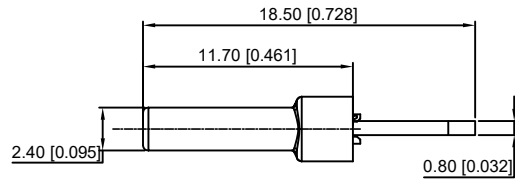
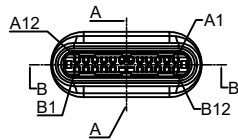
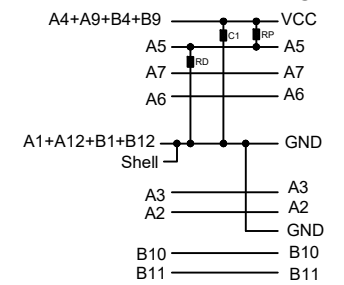
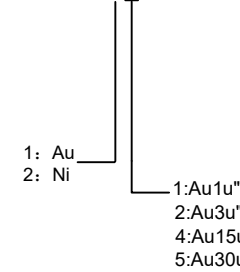

REMARKS:

1. CONTACT INSERTION AND WITHDRAW FORCE :

- 1.Insertion force : 5N-20N max.
2. Withdrawal force : 8N-20N.
- 3.Durability : 10000Cycles.

2.ELECTRIC PROPERTY :

- 1.Contact current rating : 3A.
- 2.Dielectric Strength : 100V AC(RMS).
- 3.Insulation Resistance : 100 megaohms min.
- 4.Contact resistance : 40m0hms MAX.FOR VBUS,GND AND OTHER CONTACT 50m0hms MAX.AFTER ENVIRONMENT TEST

3.AMBIENT TEMPERATURE :

- 1.Operating temperature : -55°C to +85°C.

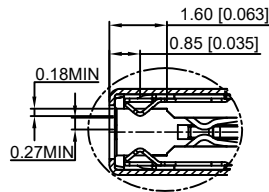
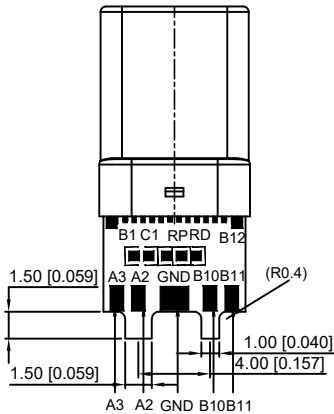

D
2:1

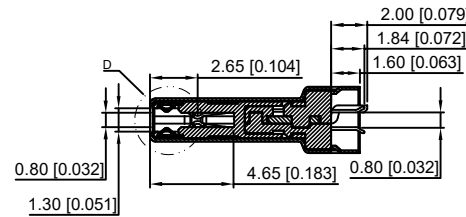

SECT A-A

A12	A11	A10	A9	A8	A7	A6	A5	A4	A3	A2	A1
GND	RX2+	RX2-	Vbus	SBU1	D-	D+	CC	Vbus	TX1-	TX1+	GND
GND	TX2+	TX2-	Vbus	Vconn			SBU2	Vbus	RX1-	RX1+	GND
B1	B2	B3	B4	B5	B6	B7	B8	B9	B10	B11	B12

6	Shrapnel	SUS T=0.10mm	
5	Shell	SUS T=0.15mm	Ovep-plating: Ni
4	Terminal	C7025 T=0.15mm	Ovep-plating: Au Ni/Sn
3	Latch	SUS T=0.4mm	
2	Housing	LCP	UL94-0
1	Housing Stopper	LCP	UL94-0
ITEM	DESCRIPTION	MATERIAL	REMARKS

MARK	DESCRIPTION	REVISIONS	DATE	REVISED	APPROVED	UNSPECIFIED TOLERANCES	DSND	DATE	SCALE: N/A	MODEL TYPE: 3.1 TYPE C		
Δx						ANGLAR ±5°	DWN	DATE	VIEW:	PART NO.:		
Δx						L ≤ 4 ±0.2	CHKD	DATE	UNIT: mm/in	DWG NO.:		
Δx						4 < L ≤ 16 ±0.3	APPD	DATE	SIZE: A4	U261-24XXN-4B0281		
						16 < L ≤ 63 ±0.4				WEIGHT 1.0g	SHEET 1/1	REVISION A0
						L > 63 ±0.5				XKB INDUSTRIAL PRECISION CO., LIMITED		

单击下面可查看定价，库存，交付和生命周期等信息

[>>XKB Connectivity\(中国星坤\)](#)