

SECT B-B

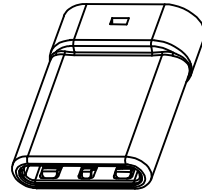

P/N	R/C
U261-24XXN-4B0284	C1 (10nF)

U261-24XXN-4B0284

- 1: Au
- 2: Ni
- 1: Au1u"
- 2: Au3u"
- 4: Au15u"
- 5: Au30u"

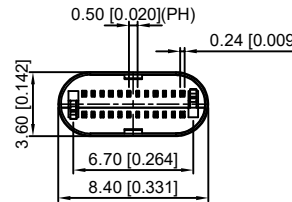
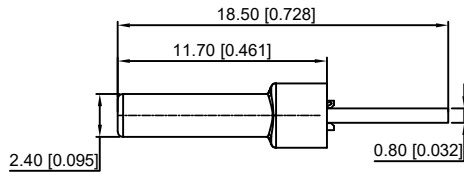
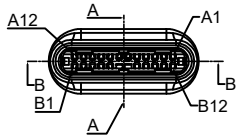
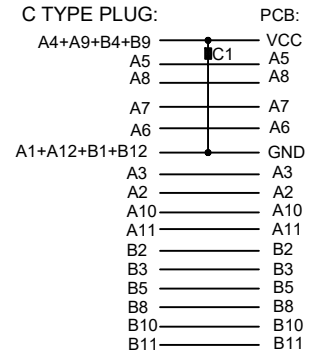

REMARKS:

- 1.CONTACT INSERTION AND WITHDRAW FORCE :
- 1.Insertion force: 5N-20N max.
  2. Withdrawal force: 8N-20N.
  - 3.Durability : 10000Cycles.
- 2.ELECTRIC PROPERTY :
- 1.Contact current rating: 3A.
  - 2.Dielectric Strength: 100V AC(RMS).
  - 3.Insulation Resistance: 100 megaohms min.
  - 4.Contact resistance: 40m0hms MAX.FOR VBUS,GND AND OTHER CONTACT 50m0hms MAX.AFTER ENVIRONMENT TEST
- 3.AMBIENT TEMPERATURE :
- 1.Operating temperature: -55°C to +85°C.

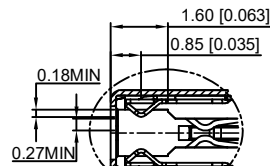
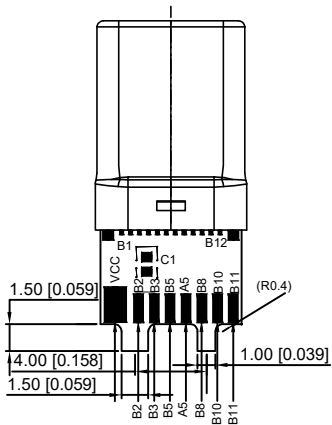

D  
2:1

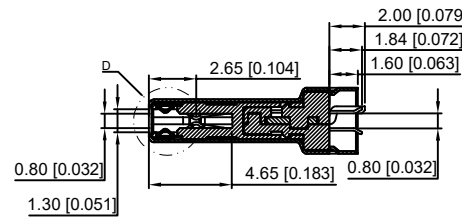

SECT A-A

A12	A11	A10	A9	A8	A7	A6	A5	A4	A3	A2	A1
GND	RX2+	RX2-	Vbus	SBU1	D-	D+	CC	Vbus	TX1-	TX1+	GND
GND	TX2+	TX2-	Vbus	Vconn			SBU2	Vbus	RX1-	RX1+	GND
B1	B2	B3	B4	B5	B6	B7	B8	B9	B10	B11	B12

6	Shrapnel	SUS T=0.10mm	
5	Shell	SUS T=0.15mm	Ovep-plating: Ni
4	Terminal	C7025 T=0.15mm	Ovep-plating: Au Ni/Sn
3	Latch	SUS T=0.4mm	
2	Housing	LCP	UL94-0
1	Housing Stopper	LCP	UL94-0
ITEM	DESCRIPTION	MATERIAL	REMARKS

DSND		DATE		SCALE: N/A	MODEL TYPE: 3.1 TYPE C		
DWN		DATE		VIEW:	PART NO.:		
CHKD		DATE		UNIT: mm/in	DWG NO.:		
APPD		DATE		SIZE: A4	U261-24XXN-4B0284		
UNSPECIFIED TOLERANCES					WEIGHT	SHEET	REVISION
www.xk-dg.cn www.helloxkb.com www.helloxkb.cn					1.0g	1/1	A0
					XKB INDUSTRIAL PRECISION CO.,LIMITED		

单击下面可查看定价，库存，交付和生命周期等信息

[>>XKB Connectivity\(中国星坤\)](#)