

SECT B-B

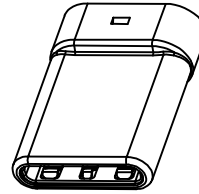

P/N	R/C
U261-24XXN-4B0355	C2, C3(0.1uF X5R 6.3V) IC,HUSB330DN6(DFN-6L)
U261-24XXN-4B0363	在C2与C3靠近IC的位置竖着贴一个(0欧姆电阻)

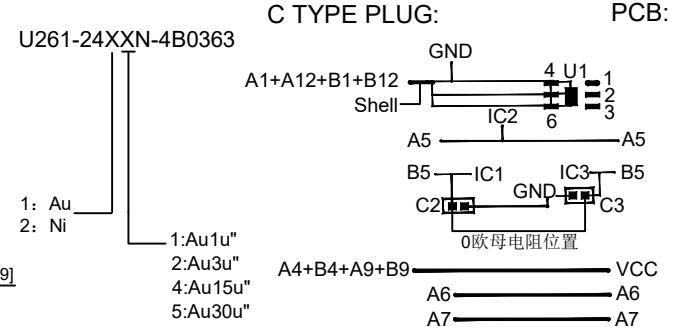

- REMARKS:
- CONTACT INSERTION AND WITHDRAW FORCE :
    - Insertion force : 5N-20N max.
    - Withdrawal force : 8N-20N.
    - Durability : 10000Cycles.
  - ELECTRIC PROPERTY :
    - Contact current rating : 3A.
    - Dielectric Strength : 100V AC(RMS).
    - Insulation Resistance : 100 megaohms min.
    - Contact resistance : 40mohms MAX.FOR VBUS,GND AND OTHER CONTACT  
50mohms MAX.AFTER ENVIRONMENT TEST
  - AMBIENT TEMPERATURE :
    - Operating temperature : -55°C to +85°C.

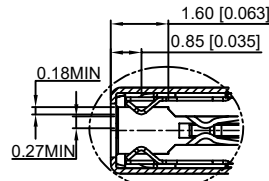
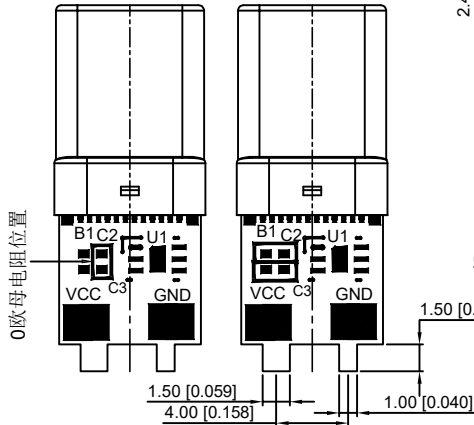
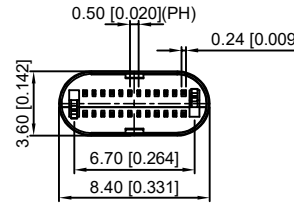
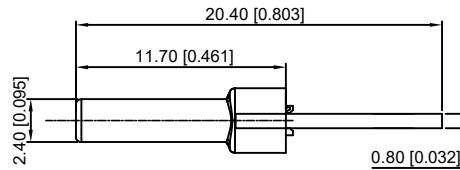
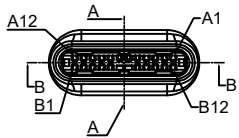

D  
2:1

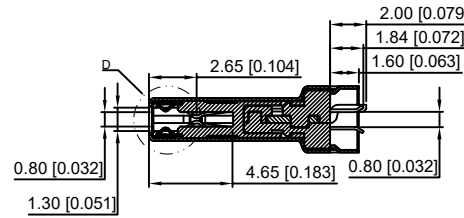

SECT A-A

A12	A11	A10	A9	A8	A7	A6	A5	A4	A3	A2	A1
GND	RX2+	RX2-	Vbus	SBU1	D-	D+	CC	Vbus	TX1-	TX1+	GND
GND	TX2+	TX2-	Vbus	Vconn			SBU2	Vbus	RX1-	RX1+	GND
B1	B2	B3	B4	B5	B6	B7	B8	B9	B10	B11	B12

ITEM	DESCRIPTION	MATERIAL	REMARKS
6	Shrapnel	SUS T=0.10mm	
5	Shell	SUS T=0.15mm	Ovep-plating: Ni
4	Terminal	C7025 T=0.15mm	Ovep-plating: Au Ni/Sn
3	Latch	SUS T=0.4mm	
2	Housing	LCP	UL94-0
1	Housing Stopper	LCP	UL94-0

MARK	DESCRIPTION	DATE	REVISED	APPROVED	UNSPECIFIED TOLERANCES	DSND	DATE	SCALE: N/A	MODEL TYPE: 3.1 TYPE C
ΔX					ANGLAR ±5°	DWN	DATE	VIEW:	PART NO.:
ΔX					L ≤ 4 ±0.2	CHKD	DATE	UNIT: mm/in	DWG NO.:
ΔX					4 < L ≤ 16 ±0.3	APPD	DATE	SIZE: A4	U261-24XXN-4B0363
ΔX					16 < L ≤ 63 ±0.4				WEIGHT SHEET REVISION
ΔX					L > 63 ±0.5				1.0g 1/1 A0

XKB INDUSTRIAL PRECISION CO., LIMITED

单击下面可查看定价，库存，交付和生命周期等信息

[>>XKB Connectivity\(中国星坤\)](#)