

AFTER MATING

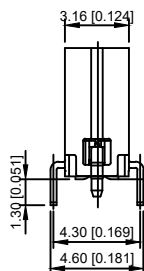

ALL CONTACT XKB

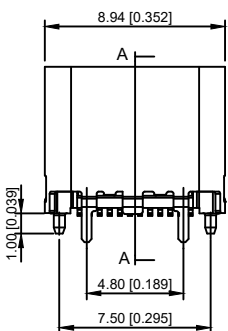
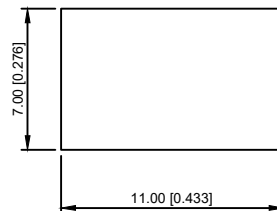
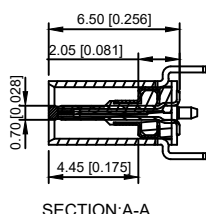
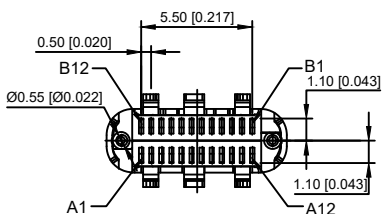
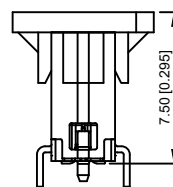
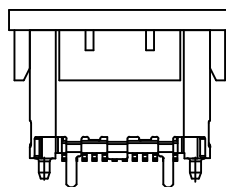
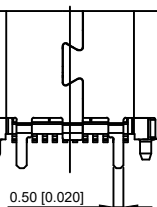

SECTION:A-A

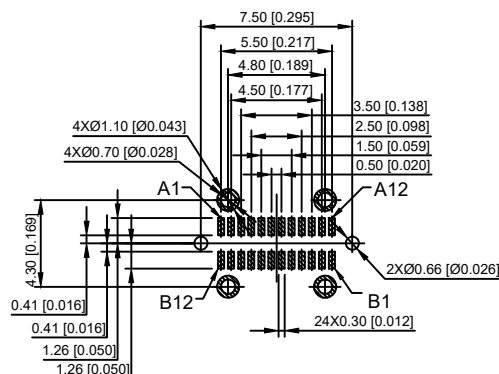

RECOMMENDED PCB LAYOUT(TOP VIEW)
DEFAULT TOLERANCE:±0.05

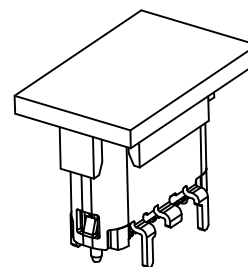

WITH PICK UP COVER
XKB

XKB

NOTE:

- 1.MATERIAL SPECIFICATION:
 - 1.HOUSING:LCP,UL94 V-0.
 - 2.TERMINAL: COPPER ALLOY
 - 3.MID PLATE: STAINLESS STEEL
 - 4.FRONT SHELL: STAINLESS STEEL
 - 5.EMI PLATE: STAINLESS STEEL
- 2.PLATING SPECIFICATION:
 - 2-1.TERMINAL:
 - Ni 50u" MIN. UNDER PLATED OVER ALL.
 - Au PLATED ON THE FUNCTIONAL AREA OF CONTACT.
 - (GOLD PLATING THICKNESS FOLLOW THE P/N)
 - PLATING SPECIFICATIONS OF THE SOLDER AREA FOLLOW THE P/N
 - 2-2.FRONT SHELL:
 - PLATING SPECIFICATIONS FOLLOW THE P/N
 - 2-3.MID PLATE&EMI PLATE:
 - CLEAR ONLY
- 3.MECHANICAL PERFORMANCE:
 - 3-1.INSERTION FORCE: 0.5~2.0kgf.
 - 3-2.REMOVAL FORCE: 0.8kgf~2.0kgf.
 - 3-3.DURABILITY: 10000 CYCLES.
- 4.ELECTRICAL PERFORMANCE:
 - 4-1.VOLTAGE RATING:5 V DC/AC (RMS. max)
 - CURRENT RATING:5 AMPS. FOR TOTAL VBUS/GND PINS;
 - 1.25AMPS FOR CC PIN,0.25 AMPS. FOR ALL OTHER CONTACT.
 - 4-2.LLCR:
 - VBUS & GND PINS AND OTHER PINS: 40mΩ/PIN MAX.
 - SHIELD: 50mΩ/MAX
 - LLCR MAX. CHANGE OF ALL PINS: 10mΩ.
 - 4-3.INSULATION RESISTANCE: 100MΩ_MIN
 - 4-4.DIELECTRIC WITHSTAND VOLTAGE,AC 100V FOR 1 MINUTE.
5. ENVIRONMENTAL PERFORMANCE:
 - OPERATING TEMPERATURE: -25°C~+85°C.
- 6.IR REFLOW:
 - THE PEAK TEMPERATURE ON THE BOARD SHALL BE MAINTAINED FOR 10 SECONDS AT 260°C.

A1	GND	B12	GND
A2	SSTXP1	B11	SSRXP1
A3	SSTXN1	B10	SSRXN1
A4	VBUS	B9	VBUS
A5	CC1	B8	SBU2
A6	DP1	B7	DN2
A7	DN1	B6	DP2
A8	SBU1	B5	CC2
A9	VBUS	B4	VBUS
A10	SSRXN2	B3	SSTXN2
A11	SSRXP2	B2	SSTXP2
A12	GND	B1	GND
PIN	SIGNAL NAME	PIN	SIGNAL NAME

U263-24XN-4BQC02

- 1:Au 1U"
- 2:Au 3U"
- 3:Au 15U"
- 4:Au 30U"
- 1:PBT
- 2:PA6T
- 3:PA9T
- 4:LCP

DSND	DATE	SCALE: N/A	MODEL TYPE: 3.1 TYPE C
DWN	DATE	VIEW:	PART NO.:
CHKD	DATE	UNIT: mm/in	DWG NO.:
APPD	DATE	SIZE: A4	U263-24XN-4BQC13
UNSPECIFIED TOLERANCES			WEIGHT
KXB INDUSTRIAL PRECISION CO.,LIMITED			SHEET
			REVISION
			1.0g
			1/1
			A0

ΔX					ANGLAR	±5°
ΔX					L ≤ 4	±0.2
ΔX					4 < L ≤ 16	±0.3
ΔX					16 < L ≤ 63	±0.4
MARK	DESCRIPTION	DATE	REVISED	APPROVED	L > 63	±0.5
REVISIONS						
www.xk-dg.cn www.helloxkb.com www.helloxkb.cn						

单击下面可查看定价，库存，交付和生命周期等信息

[>>XKB Connectivity\(中国星坤\)](#)