

For and on behalf of
XKB INDUSTRIAL PRECISION CO., LIMITED
 香港星坤工業精密有限公司

Specifications :

- Voltage rating: 350V AC / DC
- Current rating: 4 A AC / DC
- Withstanding voltage: 1700V AC/minute
- Temperature range: -25°C~+85°C
- Insulation resistance: ≥1000MΩ
- Contact resistance: ≤30mΩ
- After environmental testing: ≤20mΩ

X1800 T - P SN

① ② ③ ④

- ① Series Number
- ② Category: T-terminal
- ③ Material: P-Phosphor bronze
- ④ Plating Style: SN-Bright tin plating

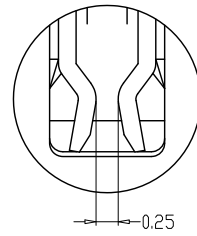
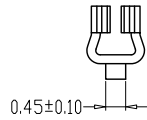
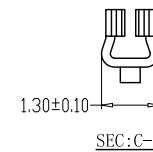
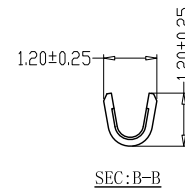
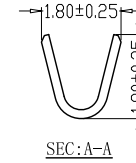
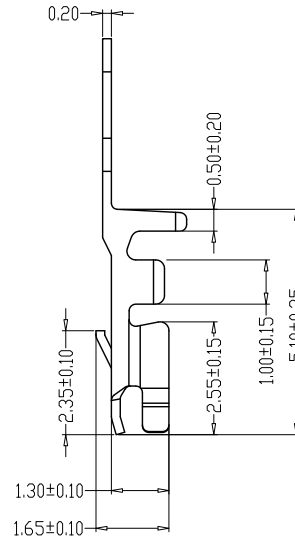
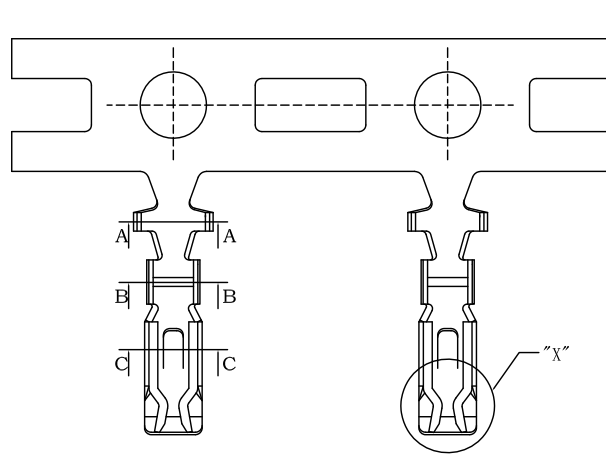

DETAIL "X"

X1800T-PSN	Phosphor Bronze	AWG#28-30	1.8 mm(Max)	Stamping Before plating:30u" MIN. Ni; 70u"Sn	X1800H
XPART NO	Material	Wire Range	Insulation O.D.	Finish	Suitable XKB Terminal

For and on behalf of
XKB INDUSTRIAL PRECISION CO., LIMITED
 香港星坤工業精密有限公司

△ X					ANGULAR	± 5°
△ X					L ≤ 4	± 0.2
△ X					4 < L ≤ 16	± 0.3
△ X					16 < L ≤ 63	± 0.4
MARK	DESCRIPTION	DATE	REVISED	APPROVED	L > 63	± 0.5

REVISIONS:
 Digitized Signature(s)

DSND	DATE	SCALE: N/A	MODEL TYPE:
DWN	DATE	VIEW:	PART NO.: 1.80mm Crimp Style Connectors
CHKD	DATE	UNIT: mm	DWG NO.: X1800T-PSN
APPD	DATE	SIZE: A4	
KXB INDUSTRIAL PRECISION CO., LIMITED			WEIGHT: 1.0g
			SHEET: 1/1
			REVISION: A0

单击下面可查看定价，库存，交付和生命周期等信息

[>>XKB Connectivity\(中国星坤\)](#)