



产品承认书 SPECIFICATION FOR APPROVAL

客户名称:

CUSTOMER

我司料号:

OUR PART NO.

XRACM4520F-SERIES

我司品名:

OUR PART NAME

贴片共模电感

送样日期:

DATE SAMPLES

数量:

QUANTITY

制造确认 MANUFACTURER APPROVE

拟制 DRAWN	审核 CHECKED	确认 APPROVED
殷瑛	董兰瑶	周俊

客户确认 CUSTOMER APPROVE

客户名称 CUSTOMER NAME:

客户料号 CUSTOMER P/N:

规格型号 DESCRIPTION: ACM4520F-SERIES 系列

检查结果: 合格 不合格

签名及盖章:

INSPECT RESULT ACCEPT REJECT

SIGNATURE AND STAMP

说明 REMARK:

如对本承认书内容有异议请提出或标记发送至我司, 本承认书在未收到异议回复时于本承认书提供一周后生效。

东莞市祥如电子有限公司

地址: 广东省东莞市塘厦镇莲湖第一工业区南二横路36号B栋

电话: 0769-86346548 传真: 0769-86346358

邮箱: dgxiangru@126.com

产品承认书/SPECIFICATION FOR APPROVAL

客户名称 CUSTOMER	-----	客户品名 CUSTOMER P/N	-----	版别 REV.	A0
产品类型 PRODUCT TYPE	Common Mode Line Filter	祥如品名 XR P/N	XRACM4520F-SERIES	文件编号 FILE NO.	XR-WI-E-019

一、产品识别/PRODUCT IDENTIFICATION:

XRACM — 4520F — 701
(1) (2) (3)

- (1) Series
- (2) Dimensions
- (3) Marking Impedance(700=70Ω 701=700Ω 702=7000Ω)

二、形状及尺寸/SHAPE AND DIMENSIONS (单位/Unit: mm)

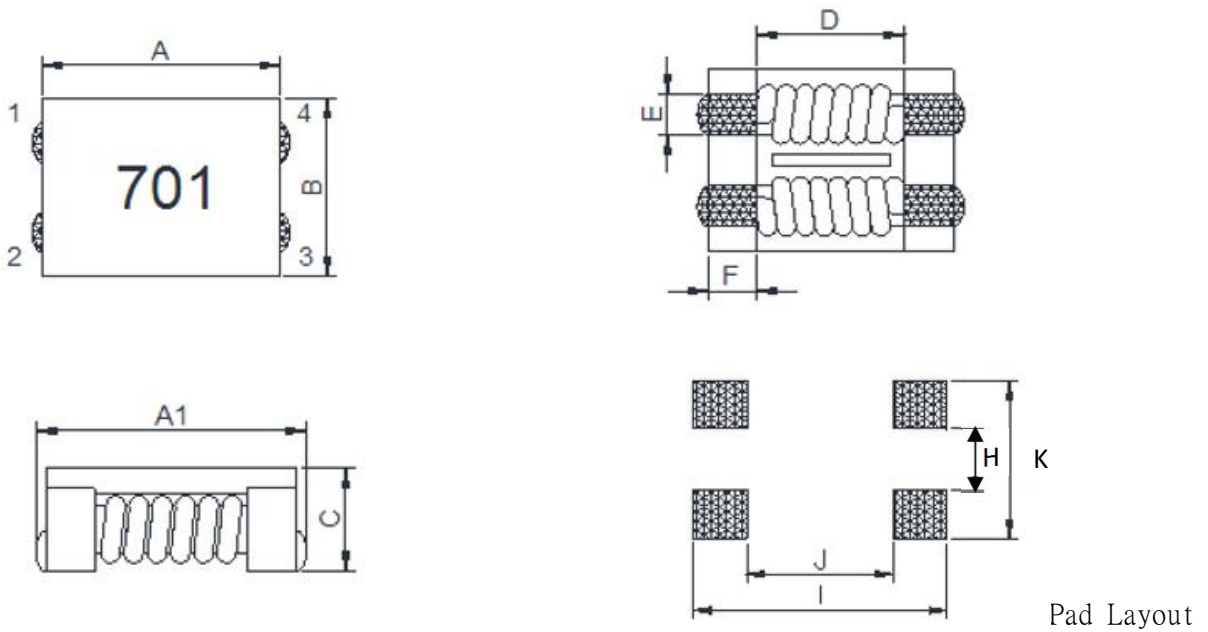

A	A1	B	C	D	E	F	K	H	I	J
4.7 ±0.5	5.2 ±0.5	4.5 ±0.5	2.3 Max	2.7 Typ	0.8 Typ	1.0 Typ	3.0 Typ	1.0 Typ	6.0 Typ	2.0 Typ

三、注意事项/NOTE:

1. 印字颜色: 白色

四、电路图/CIRCUIT DIAGRAM

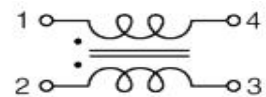

产品承认书/SPECIFICATION FOR APPROVAL

客户名称 CUSTOMER	-----	客户品名 CUSTOMER P/N	-----	版别 REV.	A0
产品类型 PRODUCT TYPE	Common Mode Line Filter	祥如品名 XR P/N	XRACM4520F-SERIES	文件编号 FILE NO.	XR-WI-E-019

五. 电气特性/ELECTRICAL CHARACTERISTIC

Part Number	Impedance (Ω) @100MHz		DC Resistance (mΩ) Max	Rated Current (A) Max	Rated Voltage (Vdc) Max	Insulation Resistance 50V/3S (MΩ) Min	Marking	Note
	MIN	TYP						
XRACM4520F-900	60	90	35.0	3.2	50	10	900	
XRACM4520F-151	90	150	40.0	3.1	50	10	151	
XRACM4520F-231	180	230	45.0	3.0	50	10	231	
XRACM4520F-301	200	300	45.0	3.0	50	10	301	
XRACM4520F-401	300	420	50.0	2.5	50	10	401	
XRACM4520F-421	350	420	50.0	2.5	50	10	421	
XRACM4520F-501	300	500	55	2.4	50	10	501	
XRACM4520F-701	500	700	59.0	2.2	50	10	701	
XRACM4520F-901	650	900	68.0	2.1	50	10	901	
XRACM4520F-102	800	1000	68.0	2.1	50	10	102	
XRACM4520F-122	1000	1200	74.0	2.0	50	10	122	
XRACM4520F-142	1200	1400	81.0	1.9	50	10	142	

Note:

- (1).Rated Current: Temp.rise 40°C Typ
- (2).Operating Temperature: -40°C up to +125°C
- (3).Storage Temperature: 15°C up to 25°C, 65% RH max.
- (4).The temperature of electrical characteristic test is 25°C indoor temperature

产品承认书/SPECIFICATION FOR APPROVAL

客户名称 CUSTOMER	-----	客户品名 CUSTOMER P/N	-----	版别 REV.	A0
产品类型 PRODUCT TYPE	Common Mode Line Filter	祥如品名 XR P/N	XRACM4520F-SERIES	文件编号 FILE NO.	XR-WI-E-019

六. 特征曲线/CHARACTERISTICS(REFERENCE)

XRACM4520F-900

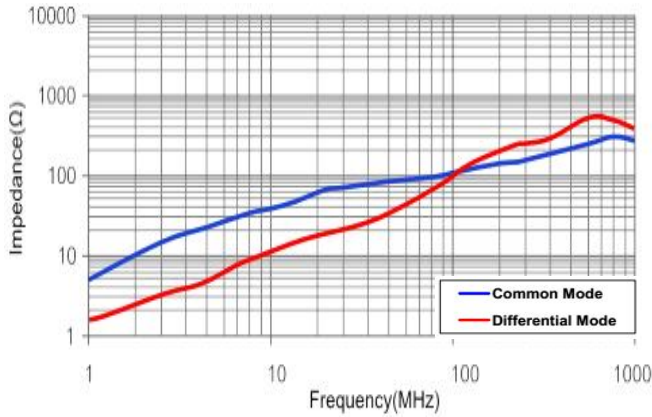

XRACM4520F-151

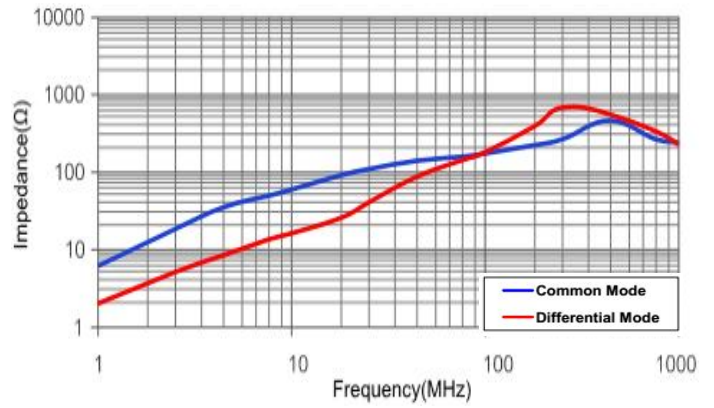

XRACM4520F-231&301

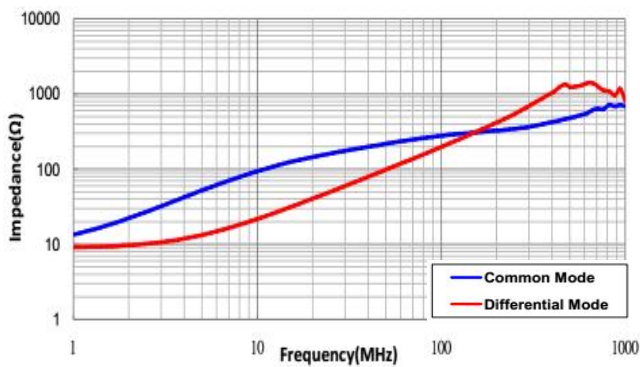

XRACM4520F-401&421

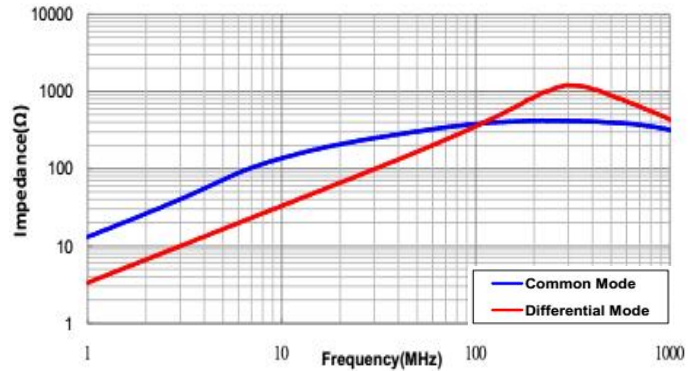

产品承认书/SPECIFICATION FOR APPROVAL

客户名称 CUSTOMER	-----	客户品名 CUSTOMER P/N	-----	版别 REV.	A0
产品类型 PRODUCT TYPE	Common Mode Line Filter	祥如品名 XR P/N	XRACM4520F-SERIES	文件编号 FILE NO.	XR-WI-E-019

六. 特征曲线/CHARACTERISTICS(REFERENCE)

XRACM4520F-701

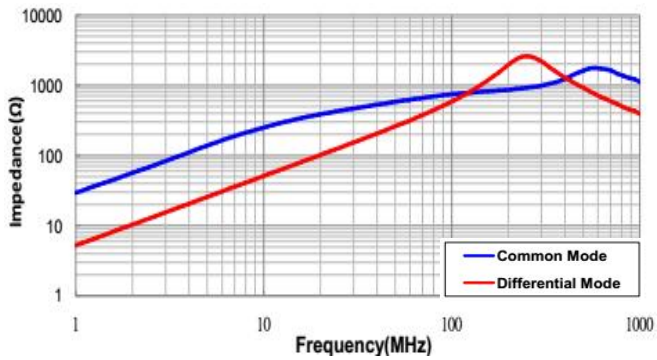

XRACM4520F-901&102

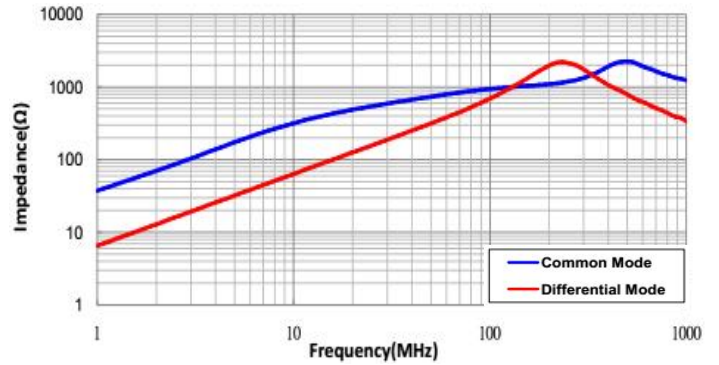

XRACM4520F-122

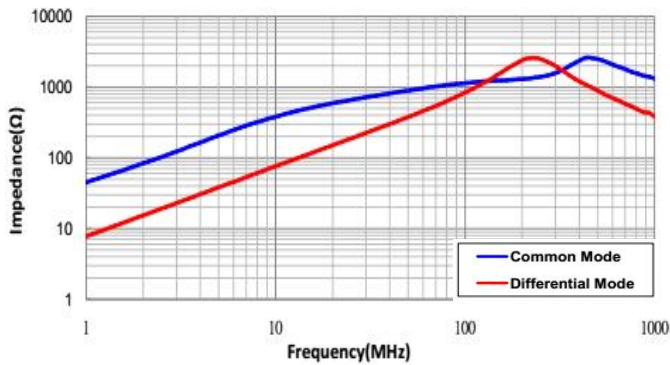

XRACM4520F-142

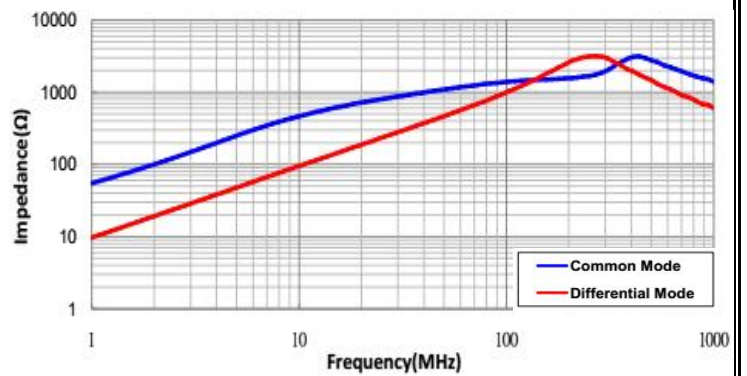

产品承认书/SPECIFICATION FOR APPROVAL

客户名称 CUSTOMER	-----	客户品名 CUSTOMER P/N	-----	版别 REV.	A0
产品类型 PRODUCT TYPE	Common Mode Line Filter	祥如品名 XR P/N	XRACM4520F-SERIES	文件编号 FILE NO.	XR-WI-E-019

七. 可靠性测试/RELIABILITY TESTING

Operating Temperature	- 40 to +125 °C (Contain Heating coil)
Appearance Inspection	No external defects by visual inspection
Terminal Strength	After soldering , between copper plaet and terminals of coils , push in two directions of X , Y with standing 10N(1.02kg) for10+/-2 sec. Terminal should not peel off. (Refer to figure at right)
Heat endurance of reflow soldering	Refer to figure
Insulating resistance	Over 10 MΩ at 50V D.C . between wire and core
Dielectric Strength	Apply at 0.5KV 1mA for 3S between wire and core
Temperature characteristics	Inductance coefficient (0~2,000) × 10 / °C(- 40~ + 125 °C)
Humidity characteristics	Inductance deviation within ± 10% , after 96 hours in 90~95% relative humidity at 40 ± 2 °C and 1 hours drying under normal condition

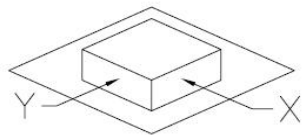

A test is made under the above mentioned condition , and it is kept for 2 hours in the normal

IR Reflow profile

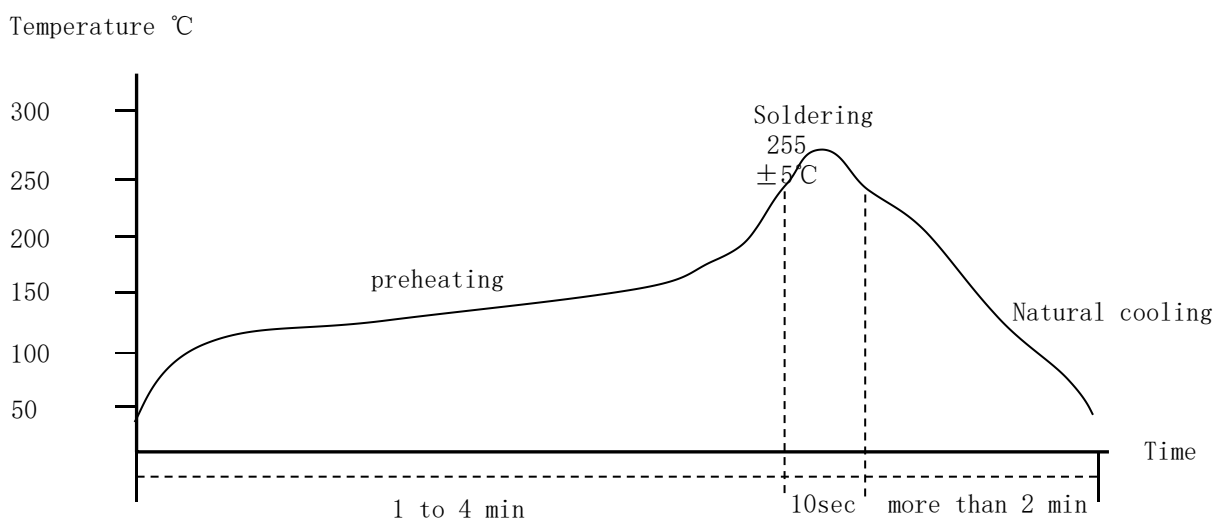

Temperature and humidity . After that , no mechanical and electrical defect should be found .

产品承认书/SPECIFICATION FOR APPROVAL

客户名称 CUSTOMER	-----	客户品名 CUSTOMER P/N	-----	版别 REV.	A0
产品类型 PRODUCT TYPE	Common Mode Line Filter	详如品名 XR P/N	XRACM4520F-SERIES	文件编号 FILE NO.	XR-WI-E-019

八. 材料清单/MATERIAL LIST

NO.	ITEM	DESCRIPTION
1	CORE	FERRITE
2	COVER	LCP
3	WIRE	P180 Grd1
4	ADHESIVE	EPOXY RESIN
5	SOLDER	LEAD-FREE
6	INK	WHITE

九. 包装规格/PACKING SPECIFICATIONS

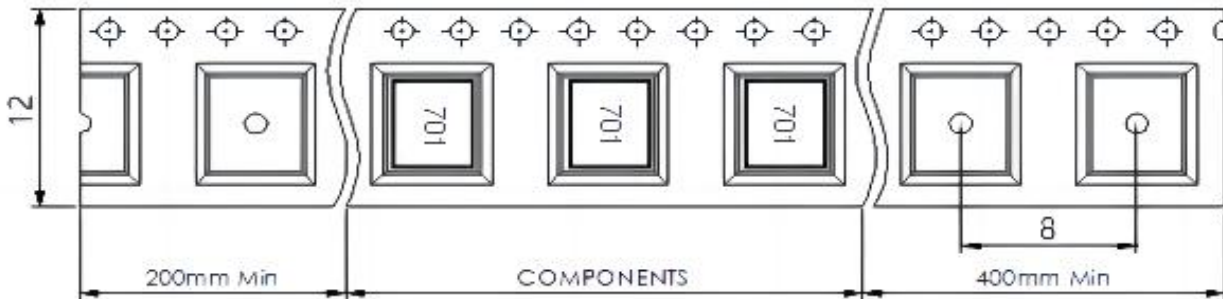

Transparent carrier and cover tape/透明载带和热封上带，预留前40CM后20CM

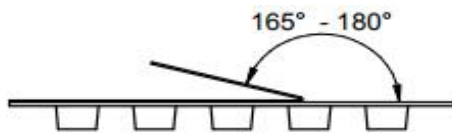

Tape width	Distance	Pull-of force
12 mm	8 mm	10~120g

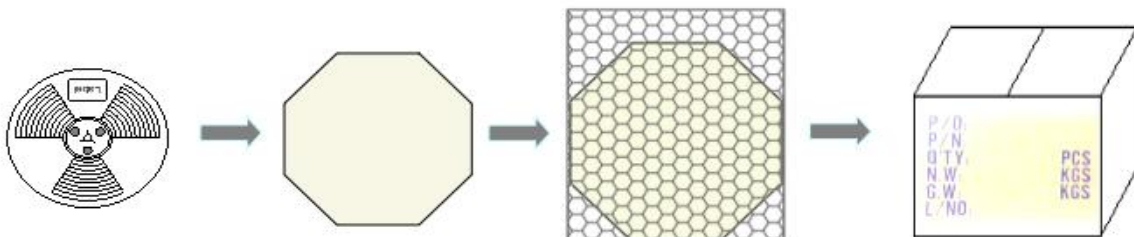

轮盘：7' (直径178mm)
数量：1000PCS/盘

内盒
数量：4000PCS/盒

套 PE袋
数量：4000PCS/袋

外箱，数量：20000PCS/箱
不足整箱用内盒或填充物
装满

产品承认书/SPECIFICATION FOR APPROVAL

客户名称 CUSTOMER	-----	客户品名 CUSTOMER P/N	-----	版别 REV.	A0
产品类型 PRODUCT TYPE	Common Mode Line Filter	祥如品名 XR P/N	XRACM4520F-SERIES	文件编号 FILE NO.	XR-WI-E-019

Cautions and Warnings

提醒及警告

1. When the products are used in occasions other than general electronic equipment, such as vehicle mounted, medical equipment, military, aerospace, etc., please be sure to contact the company's business department. In case of machine failure caused by exceeding the recommended use range of the company's products, the company will not bear relevant responsibilities (此系列產品推荐使用范围：影音, 家電, 辦公自動化, 通訊, 電源模塊, LED照明, 測量設備, 機械工具等一般電子設備中.)

2. when the company's products are used outside the general electronic equipment, such as vehicle mounted, medical, military, aviation, aerospace and other environments, please contact the company's business department and put forward a request. Otherwise, the company will not bear any relevant responsibility for the machine failure caused by the use beyond the scope recommended by the company (當本公司產品使用在一般電子設備以外, 如: 車載, 醫療, 軍用, 航空, 航天等环境时, 請必須聯繫本公司營業部門并提出述求, 否則超出本公司推薦的使用范围而引起的機器故障, 本公司不承擔任何相關責任.)

3. Please pay attention to the storage conditions that temperature: below 15-25°C and humidity: 65% RH Max. If product is preserved for more than 6 months, the solderability of their terminals may be deteriorated. (產品在規定的溫度和濕度條件下保存: 溫度: 15-25°C 以下, 濕度上限: 65% RH, 如果保存期超過半年, 端子的可焊性可能會變差.)

单击下面可查看定价，库存，交付和生命周期等信息

[>>XR\(祥如\)](#)