

Surface Mount Zener Diodes

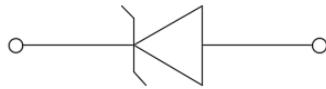
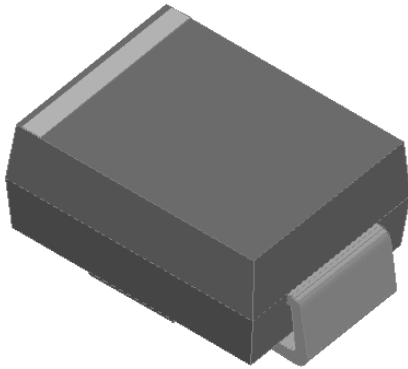

Features

- Low profile package
- Ideal for automated placement
- Glass passivated chip junction
- Meets MSL level 1, per J-STD-020, LF maximum peak of 260 °C
- Part no. with suffix "Q" means AEC-Q101 qualified

Mechanical Data

- **Package:** DO-214AA (SMB)
Molding compound meets UL 94 V-0 flammability rating, RoHS-compliant, halogen-free
- **Terminals:** Tin plated leads, solderable per J-STD-002 and JESD22-B102
- **Polarity:** Cathode line denotes the cathode end

■Maximum Ratings (T_a=25°C Unless otherwise specified)

PARAMETER	SYMBOL	UNIT	MAX
DC power dissipation at T _L = 75 °C	P _D	W	3.0
Maximum instantaneous forward voltage@ I _F =200mA	V _F	V	1.5
Maximum junction temperature	T _J	°C	-55 to +150
Storage temperature range	T _{stg}	°C	-55 to +150

■Thermal Characteristics (T_a=25°C Unless otherwise specified)

PARAMETER	SYMBOL	UNIT	Conditions	VALUE
Thermal resistance(Typical)	R _{θJ-L} ⁽¹⁾	°C/W	junction to lead	25
	R _{θJ-A} ⁽¹⁾	°C/W	junction to ambient	100

Note

(1) Thermal resistance from junction to ambient and from junction to lead mounted on P.C.B. with 0.4" x 0.4" (10 mm x 10 mm) copper pad areas



SMB3Z6.8AQ THRU SMB3Z220AQ

■Electrical Characteristics (T_a=25°C Unless otherwise specified)

Part Number	Nominal Zener voltage			Test current	Maximum dynamic impedance resistance			Maximum reverse leakage current		Maximum DC Zener Current
	Min V _Z ⁽¹⁾ at I _{ZT}	Typ. V _Z ⁽¹⁾ at I _{ZT}	Max V _Z ⁽¹⁾ at I _{ZT}	I _{ZT}	Z _{ZT} at I _{ZT}	Z _{ZK} at I _{ZK}	I _{ZK}	I _R	Test voltage V _R	I _{ZM}
	V	V	V	mA	Ω	Ω	mA	μA	V	mA
SMB3Z6.8AQ	6.46	6.8	7.14	110.0	2.0	700	1.00	10.0	4.0	393.0
SMB3Z7.5AQ	7.13	7.5	7.88	100.0	2.0	700	0.50	10.0	5.0	360.0
SMB3Z8.2AQ	7.79	8.2	8.61	91.0	2.3	700	0.50	10.0	6.0	330.0
SMB3Z9.1AQ	8.65	9.1	9.56	82.0	2.5	700	0.50	10.0	7.0	297.0
SMB3Z10AQ	9.50	10.0	10.50	75.0	3.5	700	0.25	10.0	7.6	270.0
SMB3Z11AQ	10.45	11.0	11.55	68.0	4.0	700	0.25	0.5	8.4	225.0
SMB3Z12AQ	11.40	12.0	12.60	63.0	4.5	700	0.25	0.5	9.1	246.0
SMB3Z13AQ	12.35	13.0	13.65	58.0	4.5	700	0.25	0.5	9.9	208.0
SMB3Z14AQ	13.30	14.0	14.70	53.0	5.0	700	0.25	0.5	10.6	193.0
SMB3Z15AQ	14.25	15.0	15.75	50.0	5.5	700	0.25	0.5	11.4	180.0
SMB3Z16AQ	15.20	16.0	16.80	47.0	5.5	700	0.25	0.5	12.2	169.0
SMB3Z17AQ	16.15	17.0	17.85	44.0	6.0	750.0	0.25	0.5	13.0	159.0
SMB3Z18AQ	17.10	18.0	18.90	42.0	6.0	750.0	0.25	0.5	13.7	150.0
SMB3Z19AQ	18.05	19.0	19.95	40.0	7.0	750.0	0.25	0.5	14.4	142.0
SMB3Z20AQ	19.00	20.0	21.00	37.0	7.0	750.0	0.25	0.5	15.2	135.0
SMB3Z22AQ	20.90	22.0	23.10	34.0	8.0	750.0	0.25	0.5	16.7	123.0
SMB3Z24AQ	22.80	24.0	25.20	31.0	9.0	750	0.25	0.5	18.2	112.0
SMB3Z27AQ	25.65	27.0	28.35	28.0	10.0	750	0.25	0.5	20.6	100.0
SMB3Z30AQ	28.50	30.0	31.50	25.0	16.0	1000	0.25	0.5	22.5	90.0
SMB3Z33AQ	31.35	33.0	34.65	23.0	20.0	1000	0.25	0.5	25.1	82.0
SMB3Z36AQ	34.20	36.0	37.80	21.0	22.0	1000	0.25	0.5	27.4	75.0
SMB3Z39AQ	37.05	39.0	40.95	19.0	28.0	1000	0.25	0.5	29.7	69.0
SMB3Z43AQ	40.85	43.0	45.15	17.0	33.0	1500	0.25	0.5	32.7	63.0
SMB3Z47AQ	44.65	47.0	49.35	16.0	38.0	1500	0.25	0.5	35.6	57.0
SMB3Z51AQ	48.45	51.0	53.55	15.0	45.0	1500	0.25	0.5	38.8	53.0
SMB3Z56AQ	53.20	56.0	58.80	13.0	50.0	2000	0.25	0.5	42.6	48.0
SMB3Z62AQ	58.90	62.0	65.10	12.0	55.0	2000	0.25	0.5	47.1	44.0
SMB3Z68AQ	64.60	68.0	71.40	11.0	70.0	2000	0.25	0.5	51.7	40.0
SMB3Z75AQ	71.25	75.0	78.75	10.0	85.0	2000	0.25	0.5	56.0	36.0
SMB3Z82AQ	77.90	82.0	86.10	9.1	95.0	3000	0.25	0.5	62.2	33.0
SMB3Z91AQ	86.45	91.0	95.55	8.2	115.0	3000	0.25	0.5	69.2	30.0
SMB3Z100AQ	95.00	100.0	105.00	7.5	160.0	3000	0.25	0.5	76.0	27.0
SMB3Z110AQ	104.50	110.0	115.50	6.8	225.0	4000	0.25	0.5	83.6	25.0
SMB3Z120AQ	114.00	120.0	126.00	6.3	300.0	4500	0.25	0.5	91.2	22.0
SMB3Z130AQ	123.50	130.0	136.50	5.8	375.0	5000	0.25	0.5	98.8	21.0
SMB3Z140AQ	133.00	140.0	147.00	5.3	475.0	5000	0.25	0.5	106.4	19.0
SMB3Z150AQ	142.50	150.0	157.50	5.0	550.0	6000	0.25	0.5	114.0	18.0
SMB3Z160AQ	152.00	160.0	168.00	4.7	625.0	6500	0.25	0.5	121.6	17.0
SMB3Z170AQ	161.50	170.0	178.50	4.4	650.0	7000	0.25	0.5	130.4	16.0
SMB3Z180AQ	171.00	180.0	189.00	4.2	700.0	7000	0.25	0.5	136.8	15.0
SMB3Z190AQ	180.50	190.0	199.50	4.0	800.0	8000	0.25	0.5	144.8	14.0
SMB3Z200AQ	190.00	200.0	210.00	3.7	875.0	8000	0.25	0.5	152.0	13.0
SMB3Z210AQ	199.50	210.0	220.50	3.5	950.0	8300	0.25	0.5	169.0	12.3
SMB3Z220AQ	209.00	220.0	231.00	3.3	1600.0	8500	0.25	0.5	178.0	11.6

Notes:

(1) Nominal Zener voltage Range: 95% Typ.V_Z(1) at I_{ZT}----105% Typ.V_Z(1) at I_{ZT}



SMB3Z6.8AQ THRU SMB3Z220AQ

■ Characteristics (Typical)

Fig1 : Power Temperature Derating Curve

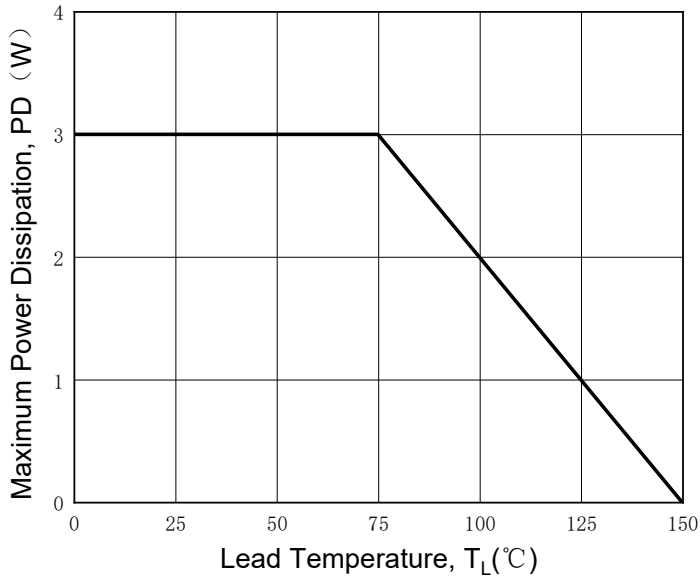

Fig2 : Typical Zener Breakdown Characteristics

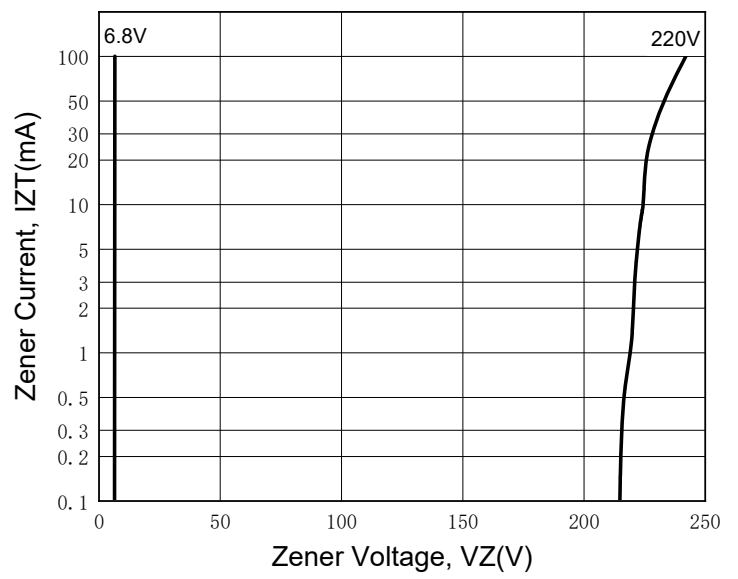
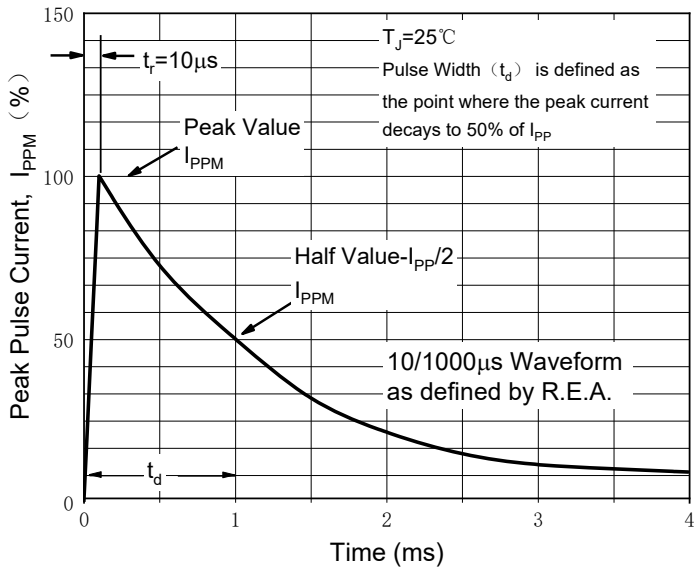

Fig.3 Pulse Waveform





SMB3Z6.8AQ THRU SMB3Z220AQ

■ Ordering Information (Example)

PREFERED P/N	PACKING CODE	UNIT WEIGHT(g)	MINIMUM PACKAGE(pcs)	OUTER CARTON QUANTITY(pcs)	DELIVERY MODE
SMB3Z6.8AQ ~SMB3Z220AQ	F1	0.1003	3000	48000	13" reel

■ Marking Information

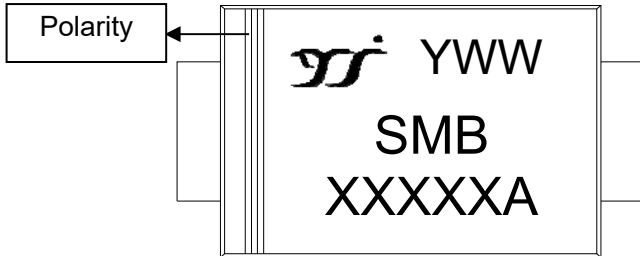

Note:

- All marking is at middle of the product body
- All marking is in laser printing
- XXX is marking code, like SMB3Z6.8AQ marking code is 3Z6.8A
- Body color: Black
- YWW is date code, "Y" is year. "WW" is week.

For instance:

The 45th week of 2022, date code is 245

■ Outline Dimensions

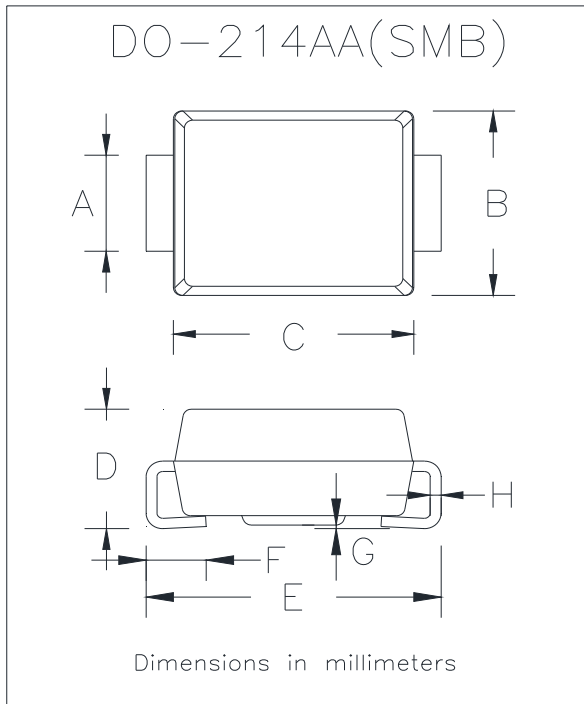

DO-214AA(SMB)		
Dim	Min	Max
A	1.85	2.15
B	3.30	3.94
C	4.05	4.75
D	1.99	2.61
E	5.21	5.59
F	0.90	1.41
G	0.05	0.20
H	0.15	0.31

■ Suggested pad layout

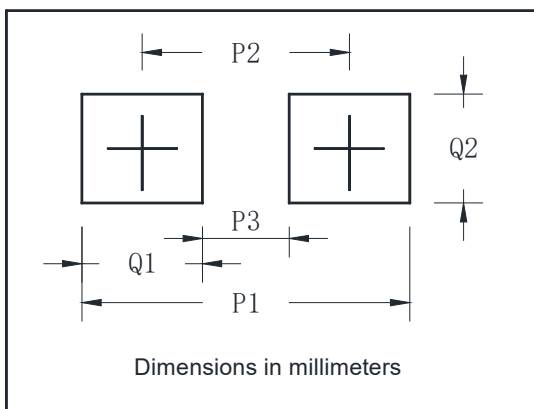

DO-214AA(SMB)	
Dim	Millimeters
P1	6.8
P2	4.3
P3	1.8
Q1	2.5
Q2	2.3



SMB3Z6.8AQ THRU SMB3Z220AQ

Disclaimer

The information presented in this document is for reference only. Yangzhou Yangjie Electronic Technology Co., Ltd. reserves the right to make changes without notice for the specification of the products displayed herein to improve reliability, function or design or otherwise.

The product listed herein is designed to be used with automotive electronics, are not designed for use in medical, lifesaving, lifesustaining, or military, Yangjie or anyone on its behalf, assumes no responsibility or liability for any damages resulting from such improper use of sale.

This publication supersedes & replaces all information previously supplied. For additional information, please visit our website [http:// www.21yangjie.com](http://www.21yangjie.com) , or consult your nearest Yangjie's sales office for further assistance.

单击下面可查看定价，库存，交付和生命周期等信息

[>>Yangjie\(扬杰\)](#)