

## Surface Mount Transient Voltage Suppressor

### Uni-directional

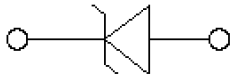

### Bi-directional

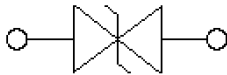

### Features

- For surface mounted applications
- Low-profile package
- Ideal for automated placement
- Available in Unidirectional
- 200 W peak pulse power capability with a 10/1000  $\mu$ s waveform
- Low incremental surge resistance, excellent clamping capability
- Very fast response time
- High temperature soldering guaranteed: 260 °C/10 s at terminals
- Meets MSL level 1
- Part no. with suffix "Q" means AEC-Q101 qualified

### Typical Applications

Use in sensitive electronics protection against voltage transients induced by inductive load switching and lighting on ICs, MOSFET, signal lines of sensor units for consumer, computer, industrial, automotive and telecommunication.

### Mechanical Date

- **Package:** SOD-123FL  
Molding compound meets UL 94 V-0 flammability rating, RoHS-compliant, halogen-free
- **Terminals:** Tin plated leads, solderable per J-STD-002 and JESD22-B102
- **Polarity:** For uni-directional types the band denotes cathode end, no marking on bi-directional types

### ■Maximum Ratings ( $T_a=25^\circ\text{C}$ Unless otherwise specified)

PARAMETER	SYMBOL	UNIT	Conditions	Max
Peak power dissipation <sup>(1) (2)</sup> (Fig.1)	$P_{PPM}$	W	with a 10/1000us waveform	200
Peak pulse current <sup>(1)</sup>	$I_{PPM}$	A	with a 10/1000us waveform	(See Next Table)
Power dissipation, on infinite heat sink	$P_D$	W	$T_a=55^\circ\text{C}$	0.4
Peak forward surge current, 8.3 ms single <sup>(3)</sup>	$I_{FSM}$	A	8.3 ms single half sine-wave	20
Operating junction and	$T_J$	$^\circ\text{C}$	-	-55 to +175
Storage temperature range	$T_{STG}$	$^\circ\text{C}$	-	-55 to +175
Thermal resistance	$R_{\theta JL}$	$^\circ\text{C/W}$	Between junction and lead	26
	$R_{\theta JA}$		Between junction and Ambient	300
	$R_{\theta JC}$		Between junction and Curve	40

Notes:

- (1). Non-repetitive current pulse at  $T_J=25^\circ\text{C}$ . per waveform of Fig3.
- (2).  $T_L=30^\circ\text{C}$  unless otherwise noted,  $V_F \leq 1.25\text{V}@200\text{mA}$ .
- (3). Measured on 8.3 ms single half sine-wave or equivalent square wave, duty cycle = 4 pulses per minute maximum



# SMF5.0AQ THRU SMF100CAQ

## Ordering Information (Example)

PREFERRED P/N	PACKING CODE	UNIT WEIGHT(g)	MINIMUM PACKAGE(pcs)	INNER BOX QUANTITY(pcs)	OUTER CARTON QUANTITY(pcs)	DELIVERY MODE
SMF SERIES	F1	0.0177	3000	30000	120000	7" reel

## Electrical Characteristics (Ta=25°C unless otherwise noted)

Part Number(Uni)	Part Number(Bi)	Marking		Breakdown Voltage $V_{BR}@I_T$			Maximum Reverse Leakage $I_R @ V_{RWM}$ ( $\mu A$ )	Working Peak Reverse Voltage $V_{RWM}$ (V)	Maximum Reverse Surge Current $I_{PP}^{(2)}$ (A)	Maximum Clamping Voltage $V_C @ I_{PP}$ (V)
		(Uni)	(Bi)	Min(V)	Max (V)	$I_T^{(1)}$ (mA)				
SMF5.0AQ	SMF5.0CAQ	5.0A	5.0CA	6.40	7.07	10	400.0	5.0	21.74	9.2
SMF6.0AQ	SMF6.0CAQ	6.0A	6.0CA	6.67	7.37	10	400.0	6.0	19.42	10.3
SMF6.5AQ	SMF6.5CAQ	6.5A	6.5CA	7.22	7.98	10	250.0	6.5	17.86	11.2
SMF7.0AQ	SMF7.0CAQ	7.0A	7.0CA	7.78	8.60	10	100.0	7.0	16.67	12.0
SMF7.5AQ	SMF7.5CAQ	7.5A	7.5CA	8.33	9.21	1	50.0	7.5	15.50	12.9
SMF8.0AQ	SMF8.0CAQ	8.0A	8.0CA	8.89	9.83	1	25.0	8.0	14.71	13.6
SMF8.5AQ	SMF8.5CAQ	8.5A	8.5CA	9.44	10.40	1	10.0	8.5	13.89	14.4
SMF9.0AQ	SMF9.0CAQ	9.0A	9.0CA	10.00	11.10	1	5.0	9.0	12.99	15.4
SMF10AQ	SMF10CAQ	10A	10CA	11.10	12.30	1	2.5	10.0	11.76	17.0
SMF11AQ	SMF11CAQ	11A	11CA	12.20	13.50	1	2.5	11.0	10.99	18.2
SMF12AQ	SMF12CAQ	12A	12CA	13.30	14.70	1	2.5	12.0	10.05	19.9
SMF13AQ	SMF13CAQ	13A	13CA	14.40	15.90	1	1.0	13.0	9.30	21.5
SMF14AQ	SMF14CAQ	14A	14CA	15.60	17.20	1	1.0	14.0	8.62	23.2
SMF15AQ	SMF15CAQ	15A	15CA	16.70	18.50	1	1.0	15.0	8.20	24.4
SMF16AQ	SMF16CAQ	16A	16CA	17.80	19.70	1	1.0	16.0	7.69	26.0
SMF17AQ	SMF17CAQ	17A	17CA	18.90	20.90	1	1.0	17.0	7.25	27.6
SMF18AQ	SMF18CAQ	18A	18CA	20.00	22.10	1	1.0	18.0	6.85	29.2
SMF19AQ	SMF19CAQ	19A	19CA	21.10	23.30	1	1.0	19.0	6.54	30.6
SMF20AQ	SMF20CAQ	20A	20CA	22.20	24.50	1	1.0	20.0	6.17	32.4
SMF22AQ	SMF22CAQ	22A	22CA	24.40	26.90	1	1.0	22.0	5.63	35.5
SMF24AQ	SMF24CAQ	24A	24CA	26.70	29.50	1	1.0	24.0	5.14	38.9
SMF26AQ	SMF26CAQ	26A	26CA	28.90	31.90	1	1.0	26.0	4.75	42.1
SMF28AQ	SMF28CAQ	28A	28CA	31.10	34.40	1	1.0	28.0	4.41	45.4
SMF30AQ	SMF30CAQ	30A	30CA	33.30	36.80	1	1.0	30.0	4.13	48.4
SMF33AQ	SMF33CAQ	33A	33CA	36.70	40.60	1	1.0	33.0	3.75	53.3
SMF36AQ	SMF36CAQ	36A	36CA	40.00	44.20	1	1.0	36.0	3.44	58.1
SMF40AQ	SMF40CAQ	40A	40CA	44.40	49.10	1	1.0	40.0	3.10	64.5
SMF43AQ	SMF43CAQ	43A	43CA	47.80	52.80	1	1.0	43.0	2.88	69.4
SMF45AQ	SMF45CAQ	45A	45CA	50.00	55.30	1	1.0	45.0	2.75	72.7
SMF48AQ	SMF48CAQ	48A	48CA	53.30	58.90	1	1.0	48.0	2.58	77.4
SMF51AQ	SMF51CAQ	51A	51CA	56.70	62.70	1	1.0	51.0	2.43	82.4
SMF54AQ	SMF54CAQ	54A	54CA	60.00	66.30	1	1.0	54.0	2.30	87.1
SMF58AQ	SMF58CAQ	58A	58CA	64.40	71.20	1	1.0	58.0	2.14	93.6
SMF60AQ	SMF60CAQ	60A	60CA	66.70	73.70	1	1.0	60.0	2.07	96.8
SMF64AQ	SMF64CAQ	64A	64CA	71.10	78.60	1	1.0	64.0	1.94	103.0
SMF70AQ	SMF70CAQ	70A	70CA	77.80	86.00	1	1.0	70.0	1.77	113.0
SMF75AQ	SMF75CAQ	75A	75CA	83.30	92.10	1	1.0	75.0	1.65	121.0
SMF78AQ	SMF78CAQ	78A	78CA	86.70	95.80	1	1.0	78.0	1.59	126.0
SMF80AQ	SMF80CAQ	80A	80CA	88.80	97.60	1	1.0	80.0	1.55	129.0
SMF85AQ	SMF85CAQ	85A	85CA	94.40	104.00	1	1.0	85.0	1.46	137.0
SMF90AQ	SMF90CAQ	90A	90CA	100.00	111.00	1	1.0	90.0	1.37	146.0
SMF100AQ	SMF100CAQ	100A	100CA	111.00	123.00	1	1.0	100.0	1.23	162.0

Notes:

- (1)  $t_p \leq 50ms$  Pulse test:  $t_p \leq 50ms$ .
- (2) Surge current waveform per Fig. 2 and derated per Fig.3.



# SMF5.0AQ THRU SMF100CAQ

## ■ Characteristics(Typical)

Fig.1 Peak Pulse Power Rating Curve

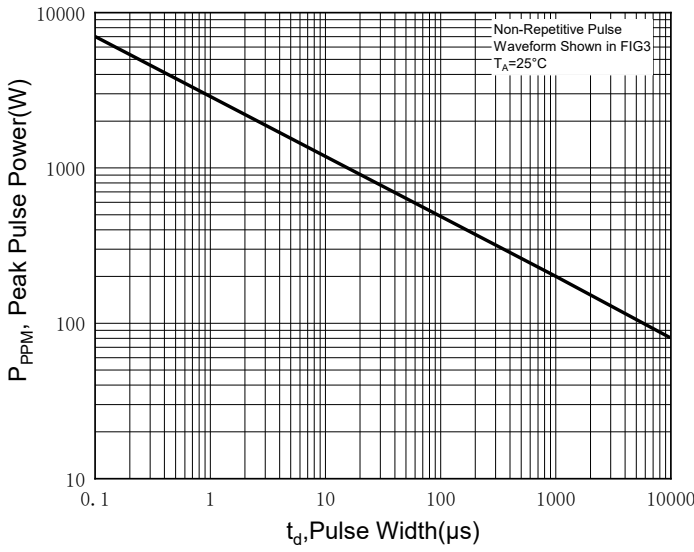

Fig.2 Pulse Waveform

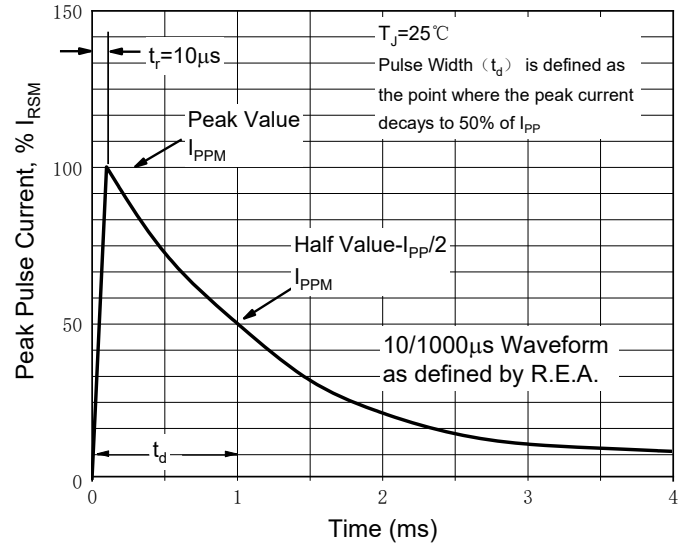

Fig.3 Pulse Power or Current vs. Initial Junction Temperature

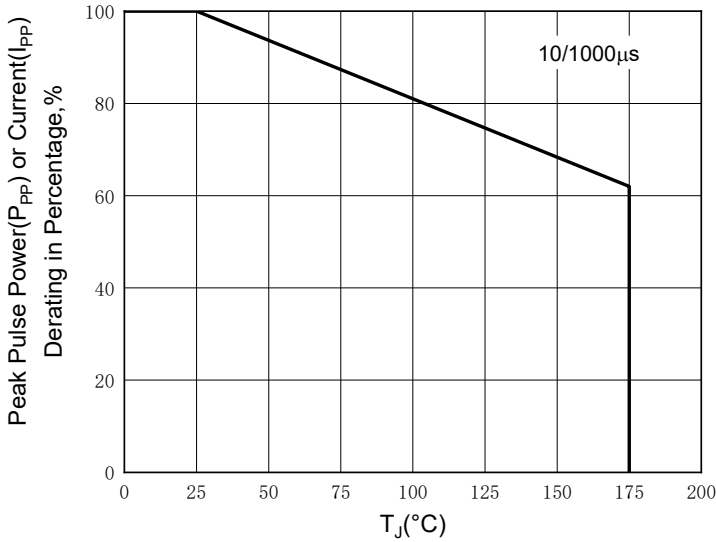

Fig.4 Forward Voltage Curve

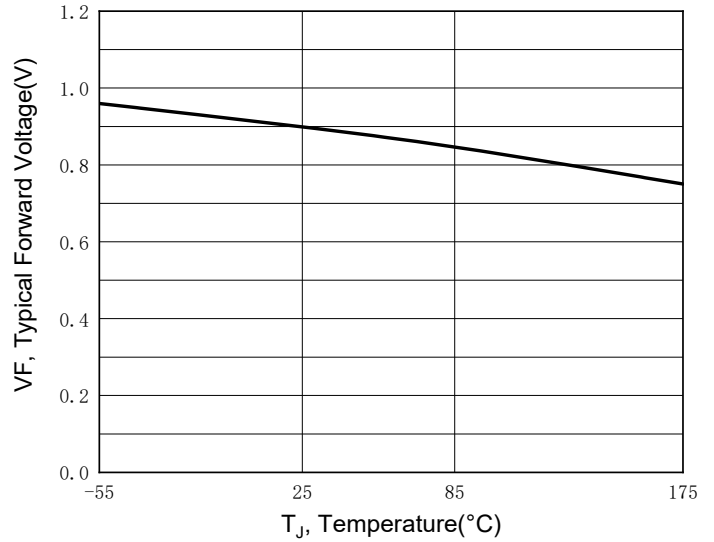
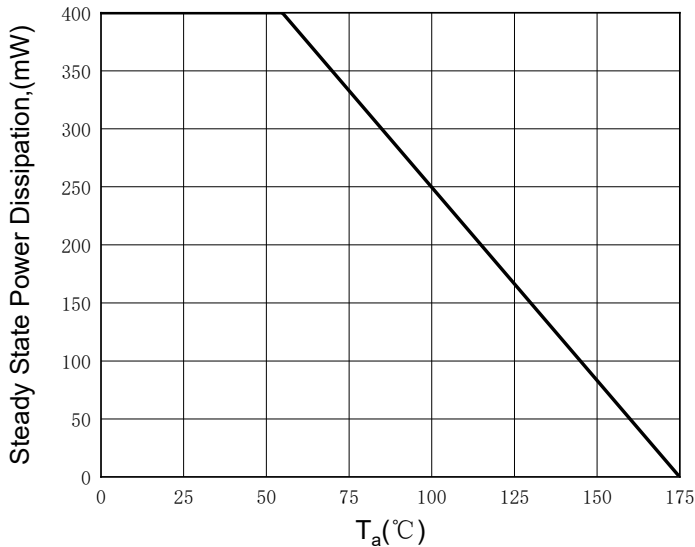

Fig.5 Steady State Power Derating Curve





# SMF5.0AQ THRU SMF100CAQ

## ■ Marking Information

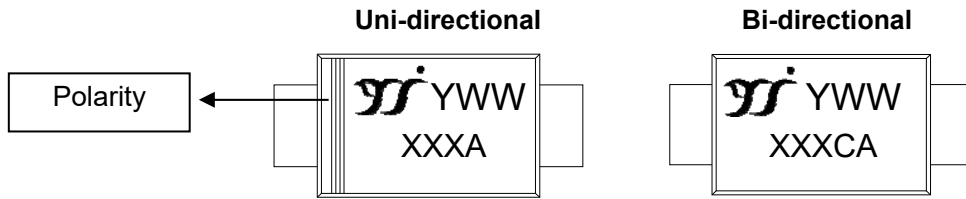

Note:  
 1. All marking is at middle of the product body  
 2. All marking is in laser printing  
 3. XXXA is marking code, like SMF100A/100CA marking code is 100  
 4. Body color: Black  
 5. YWW is date code, "Y" is year. "WW" is week.  
 For instance:  
     The 17<sup>th</sup> week of 2021, date code is 117  
     The 17<sup>th</sup> week of 2022, date code is 217

## ■ Outline Dimensions

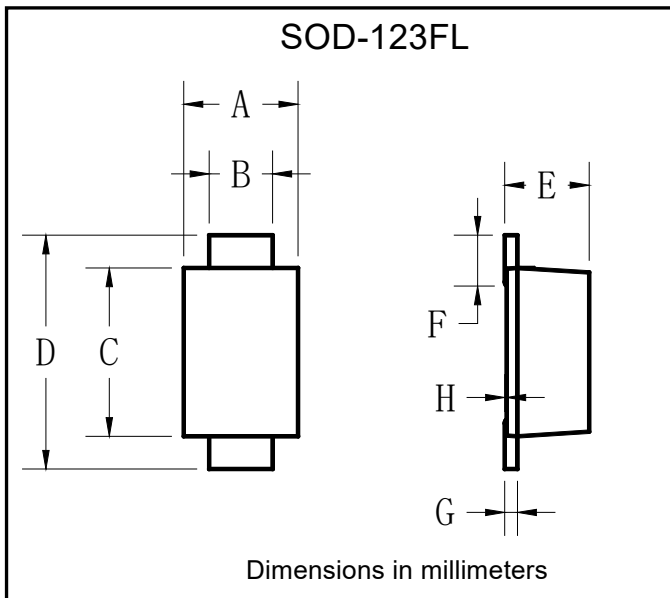

SOD-123FL		
Dim	Min	Max
A	1.60	1.90
B	0.90	1.10
C	2.55	2.85
D	3.60	3.90
E	1.00	1.20
F	0.40	0.90
G	0.10	0.25
H	0.02	0.05

## ■ Suggested pad layout

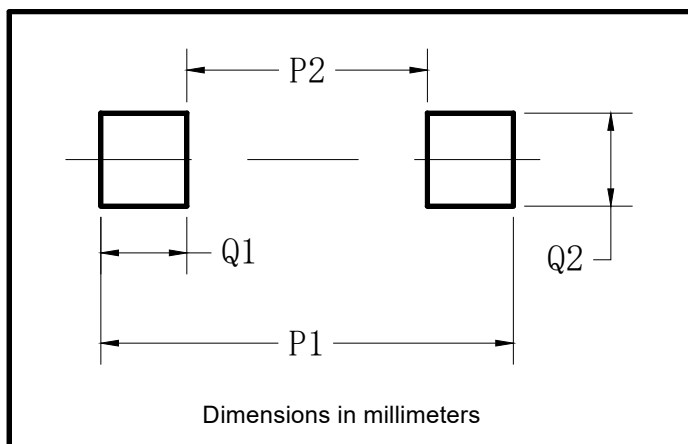

SOD-123FL	
Dim	Millimeters
P1	3.90
P2	1.90
Q1	1.00
Q2	1.50



## SMF5.0AQ THRU SMF100CAQ

---

### Disclaimer

The information presented in this document is for reference only. Yangzhou Yangjie Electronic Technology Co., Ltd. reserves the right to make changes without notice for the specification of the products displayed herein to improve reliability, function or design or otherwise.

The product listed herein is designed to be used with automotive electronics, are not designed for use in medical, lifesaving, lifesustaining, or military, Yangjie or anyone on its behalf, assumes no responsibility or liability for any damages resulting from such improper use of sale.

This publication supersedes & replaces all information previously supplied. For additional information, please visit our website [http:// www.21yangjie.com](http://www.21yangjie.com) , or consult your nearest Yangjie's sales office for further assistance.

单击下面可查看定价，库存，交付和生命周期等信息

[>>Yangjie\(扬杰\)](#)