

Surface Mount Super Fast Recovery Rectifier

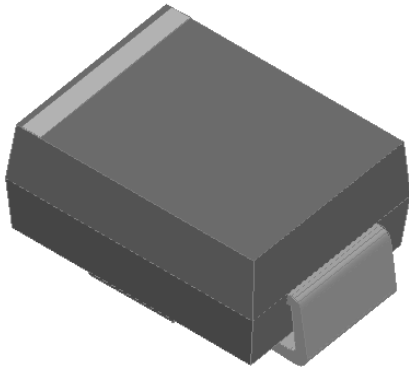

Features

- Low profile package
- Ideal for automated placement
- Glass passivated chip junction
- High forward surge capability
- Super Fast reverse recovery time
- Meets MSL level 1, per J-STD-020, LF maximum peak of 260 °C

Typical Applications

For use in high frequency rectification of power supplies, inverters, converters, and freewheeling diodes for consumer, and telecommunication.



Mechanical Data

- **Package:** DO-214AA (SMB)
Molding compound meets UL 94 V-0 flammability rating, RoHS-compliant, halogen-free
- **Terminals:** Tin plated leads, solderable per J-STD-002 and JESD22-B102
- **Polarity:** Cathode line denotes the cathode end

■ Maximum Ratings (T_a=25°C Unless otherwise specified)

PARAMETER	SYMBOL	UNIT	ES3AB	ES3BB	ES3CB	ES3DB	ES3FB	ES3GB	ES3HB	ES3JB	ES3KB
Device marking code			ES3AB	ES3BB	ES3CB	ES3DB	ES3FB	ES3GB	ES3HB	ES3JB	ES3KB
Maximum Repetitive Peak Reverse Voltage	VRRM	V	50	100	150	200	300	400	500	600	800
Maximum RMS Voltage	VRMS	V	35	70	105	140	210	280	350	420	560
Maximum DC blocking Voltage	VDC	V	50	100	150	200	300	400	500	600	800
Average rectified output current @60Hz sine wave, resistance load, TL (Fig.1)	I _O	A	3.0								
Forward Surge Current (Non-repetitive) @60Hz Half-sine wave, 1 cycle, T _j =25°C	I _{FSM}	A	100								
Forward Surge Current (Non-repetitive) @1ms, square wave, 1 cycle, T _j =25°C			200								
Current squared time @1ms≤t≤8.3ms T _j =25°C	I ² t	A ² s	41.5								
Storage temperature	T _{stg}	°C	-55 ~ +150								
Junction temperature	T _j	°C	-55 ~ +150								



ES3AB THRU ES3KB

■ Electrical Characteristics (T_a=25°C Unless otherwise specified)

PARAMETER	SYMBOL	UNIT	TEST CONDITIONS	ES3AB	ES3BB	ES3CB	ES3DB	ES3FB	ES3GB	ES3HB	ES3JB	ES3KB
Maximum instantaneous forward voltage	V _F	V	IFM=3.0A	0.95			1.3		1.7		1.85	
Maximum reverse recovery time	t _r	ns	IF=0.5A, IR=1.0A, I _{rr} =0.25A	35								
Maximum DC reverse current at rated DC blocking voltage	I _R	μA	T _j =25°C	5								
			T _j =125°C	100								
Typical junction capacitance	C _j	pF	Measured at 1MHz and Applied Reverse Voltage of 4.0 V.D.C	60			35		29		21	

■ Thermal Characteristics (T_a=25°C Unless otherwise specified)

PARAMETER	SYMBOL	UNIT	ES3AB	ES3BB	ES3CB	ES3DB	ES3FB	ES3GB	ES3HB	ES3JB	ES3KB
Typical Thermal Resistance	R _{θJ-A} ⁽¹⁾	°C/W	65								
	R _{θJ-L} ⁽¹⁾		20								
	R _{θJ-C} ⁽¹⁾		18								

Note:
 (1) Thermal resistance from junction to ambient and from junction to lead mounted on P.C.B. with 0.3" x 0.3" (8.0 mm x 8.0 mm) copper pad areas

■ Characteristics (Typical)

FIG1: I_o-T_L Curve

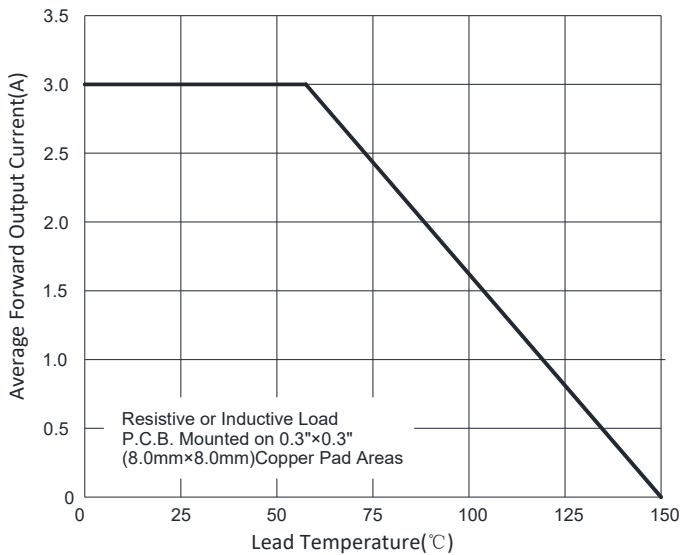
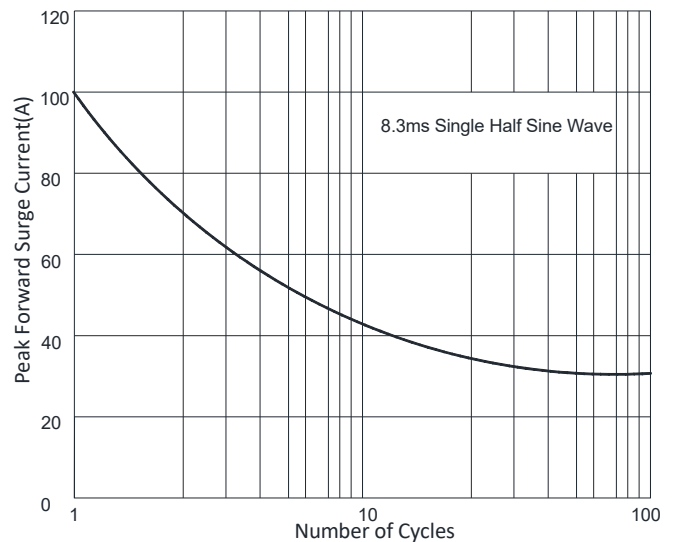

FIG2: Surge Forward Current Capability





ES3AB THRU ES3KB

FIG3: Typical Forward Voltage

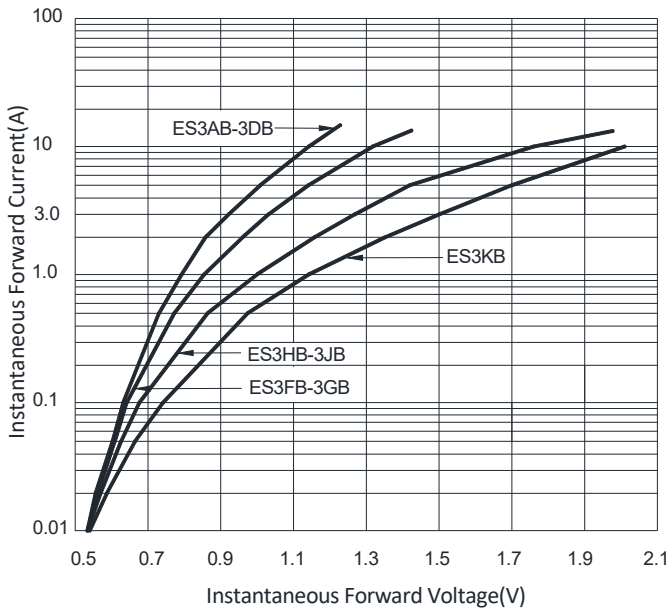

FIG4: Typical Reverse Characteristics

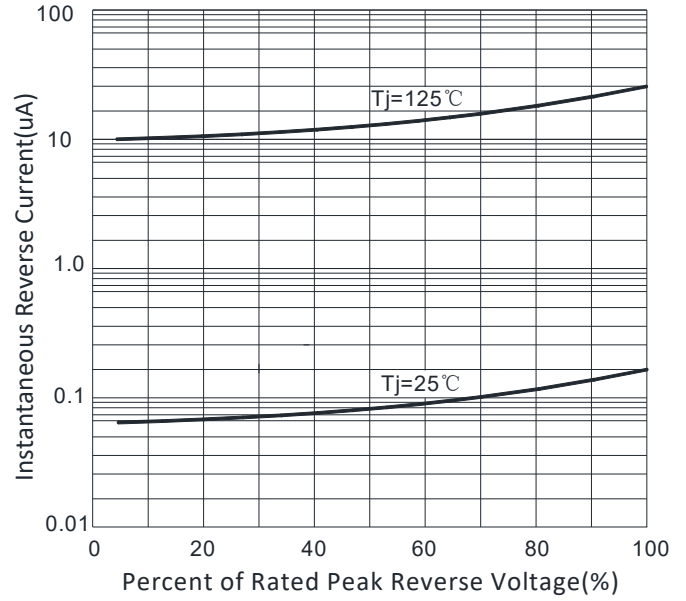
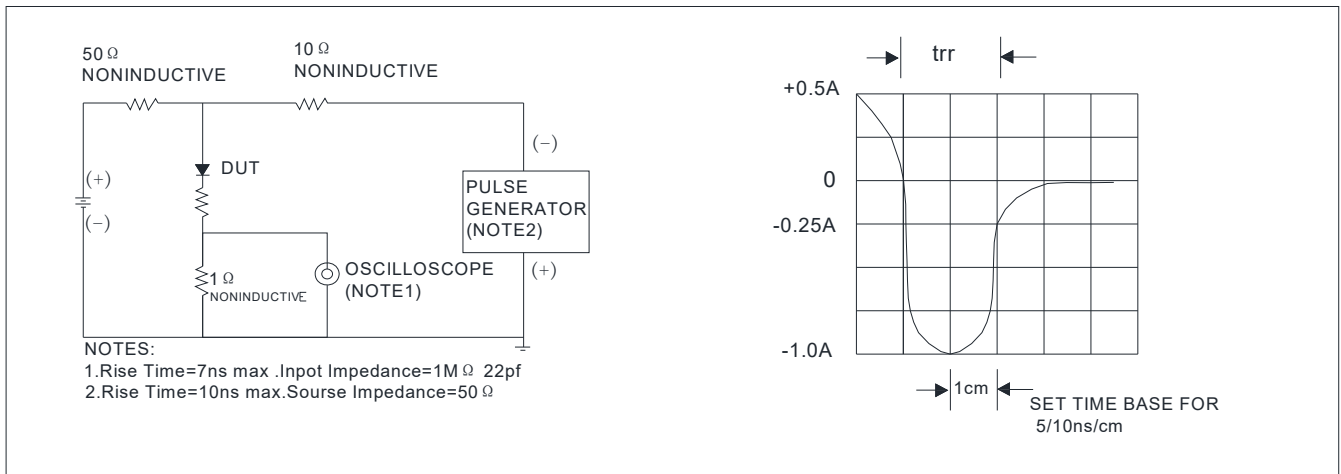

FIG.5: Diagram of circuit and Testing wave form of reverse recovery time



Ordering Information (Example)

PREFERED P/N	PACKING CODE	UNIT WEIGHT(g)	MINIMUM PACKAGE(pcs)	INNER BOX QUANTITY(pcs)	OUTER CARTON QUANTITY(pcs)	DELIVERY MODE
ES3AB-ES3KB	F1	Approximate 0.096	3000	/	48000	13" reel
ES3AB-ES3KB	F2	Approximate 0.096	750	6000	24000	7" reel
ES3AB-ES3KB	F3	Approximate 0.096	500	4000	16000	7" reel



ES3AB THRU ES3KB

■ Outline Dimensions

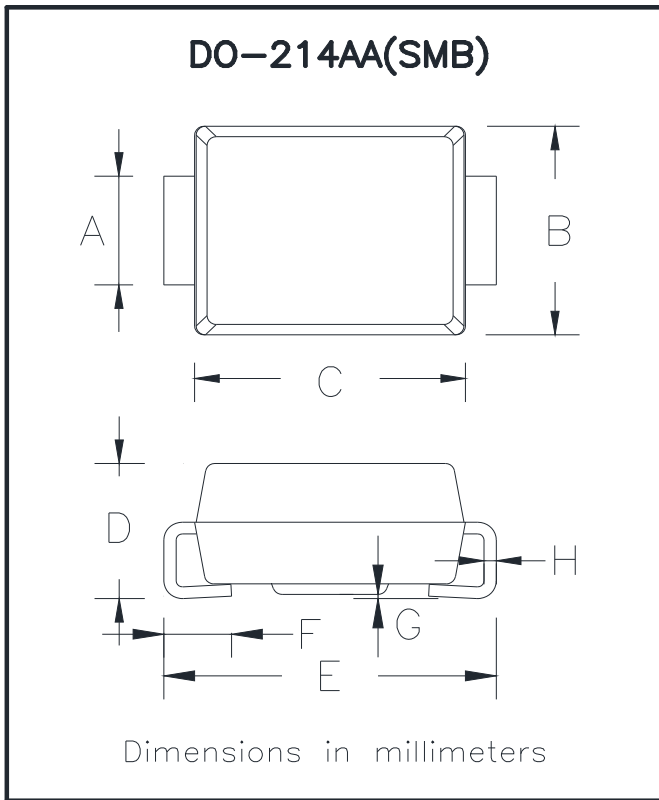

DO-214AA(SMB)		
Dim	Min	Max
A	1.85	2.15
B	3.30	3.94
C	4.05	4.75
D	1.99	2.61
E	5.21	5.59
F	0.90	1.41
G	0.05	0.20
H	0.15	0.31

■ Suggested pad layout

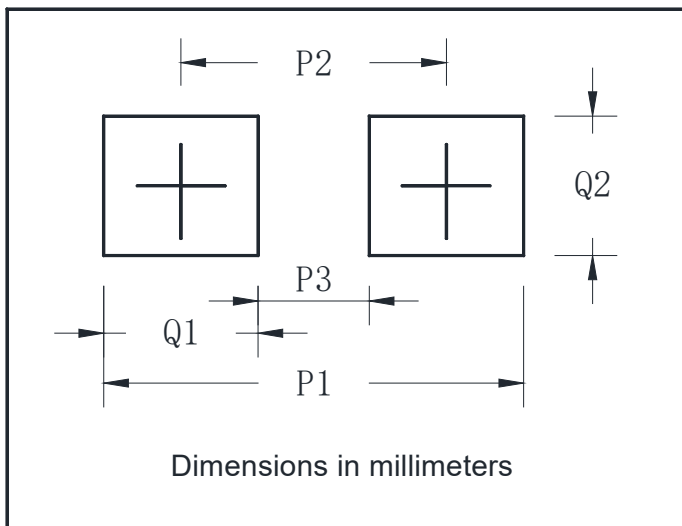

DO-214AA(SMB)	
Dim	Millimeters
P1	6.8
P2	4.3
P3	1.8
Q1	2.5
Q2	2.3



ES3AB THRU ES3KB

Disclaimer

The information presented in this document is for reference only. Yangzhou Yangjie Electronic Technology Co., Ltd. reserves the right to make changes without notice for the specification of the products displayed herein to improve reliability, function or design or otherwise.

The product listed herein is designed to be used with ordinary electronic equipment or devices, and not designed to be used with equipment or devices which require high level of reliability and the malfunction of which would directly endanger human life (such as medical instruments, transportation equipment, aerospace machinery, nuclear-reactor controllers, fuel controllers and other safety devices), Yangjie or anyone on its behalf, assumes no responsibility or liability for any damages resulting from such improper use of sale.

This publication supersedes & replaces all information previously supplied. For additional information, please visit our website [http:// www.21yangjie.com](http://www.21yangjie.com) , or consult your nearest Yangjie's sales office for further assistance.

单击下面可查看定价，库存，交付和生命周期等信息

[>>Yangjie\(扬杰\)](#)