

## Zener Diodes

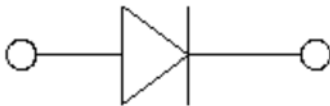

### Features

- Moisture sensitivity level 1
- Zener voltage 2.4V~75V

### Application

- Linear voltage regulator
- DC regulator
- Small-signal surge protection

### Mechanical data

- **Package:** SOD-123
- **Terminals:** Tin plated leads, solderable per J-STD-002 and JESD22-B102

### ■ Maximum Ratings (T<sub>a</sub>=25°C Unless otherwise specified)

Parameter	Symbol	Unit	Value
Forward voltage @ I <sub>F</sub> =10mA	V <sub>F</sub>	V	0.9
Power dissipation	P <sub>D</sub>	mW	500
Maximum regulator current	I <sub>ZM</sub>	mA	P <sub>D</sub> /V <sub>Z</sub>
Junction temperature	T <sub>J</sub>	°C	-55 to +150
Storage temperature	T <sub>STG</sub>	°C	-55 to +150



# BZT52C2V4 THRU BZT52C75

RoHS  
COMPLIANT

## ■ Electrical Characteristics (T<sub>a</sub>=25°C Unless otherwise specified)

Type number	Device marking	V <sub>Z</sub> @ I <sub>ZT</sub> (V)			Z <sub>ZT</sub> (Ω)		Z <sub>ZK</sub> (Ω)		I <sub>R</sub> (μA) @V <sub>R</sub>		Typical temperature coefficient @ I <sub>ZTC</sub> mV/°C		Test Current I <sub>ZTC</sub>
		min.	typ.	max.	I <sub>ZT</sub> (mA)	max.	I <sub>ZK</sub> (mA)	max.	max	V <sub>R</sub> (V)	Min	Max	mA
BZT52C2V4	WX	2.28	2.4	2.52	5	100	1.0	600	50	1.0	-3.5	0	5
BZT52C2V7	W1	2.57	2.7	2.84	5	100	1.0	600	20	1.0	-3.5	0	5
BZT52C3V0	W2	2.85	3.0	3.15	5	95	1.0	600	10	1.0	-3.5	0	5
BZT52C3V3	W3	3.14	3.3	3.47	5	95	1.0	600	5	1.0	-3.5	0	5
BZT52C3V6	W4	3.42	3.6	3.78	5	90	1.0	600	5	1.0	-3.5	0	5
BZT52C3V9	W5	3.71	3.9	4.1	5	90	1.0	600	3	1.0	-3.5	0	5
BZT52C4V3	W6	4.09	4.3	4.52	5	90	1.0	600	3	1.0	-3.5	0	5
BZT52C4V7	W7	4.47	4.7	4.94	5	80	1.0	500	3	2.0	-3.5	0	5
BZT52C5V1	W8	4.85	5.1	5.36	5	60	1.0	480	2	2.0	-2.7	1.2	5
BZT52C5V6	W9	5.32	5.6	5.88	5	40	1.0	400	1	2.0	-2	2.5	5
BZT52C6V2	WA	5.8	6.2	6.6	5	10	1.0	150	3	4.0	0.4	3.7	5
BZT52C6V8	WB	6.4	6.8	7.2	5	15	1.0	80	2	4.0	1.2	4.5	5
BZT52C7V5	WC	7.0	7.5	7.9	5	15	1.0	80	1	5.0	2.5	5.3	5
BZT52C8V2	WD	7.7	8.2	8.7	5	15	1.0	80	0.7	5.0	3.2	6.2	5
BZT52C9V1	WE	8.5	9.1	9.6	5	15	1.0	100	0.5	6.0	3.8	7.0	5
BZT52C10	WF	9.4	10	10.6	5	20	1.0	150	0.2	7.0	4.5	8.0	5
BZT52C11	WG	10.4	11	11.6	5	20	1.0	150	0.1	8.0	5.4	9.0	5
BZT52C12	WH	11.4	12	12.7	5	25	1.0	150	0.1	8.0	6.0	10.0	5
BZT52C13	WI	12.4	13	14.1	5	30	1.0	170	0.1	8.0	7.0	11.0	5
BZT52C15	WJ	14.25	15	15.6	5	30	1.0	200	0.1	10.5	9.2	13.0	5
BZT52C16	WK	15.3	16	17.1	5	40	1.0	200	0.1	11.2	10.4	14.0	5
BZT52C18	WL	16.8	18	19.1	5	45	1.0	225	0.1	12.6	12.4	16.0	5
BZT52C20	WM	18.8	20	21.2	5	55	1.0	225	0.1	14.0	14.4	18.0	5
BZT52C22	WN	20.8	22	23.3	5	55	1.0	250	0.1	15.4	16.4	20.0	5
BZT52C24	WO	22.8	24	25.6	5	70	1.0	250	0.1	16.8	18.4	22.0	5
BZT52C27	WP	25.1	27	28.9	2	80	0.5	300	0.1	18.9	21.4	25.3	2



# BZT52C2V4 THRU BZT52C75

RoHS  
COMPLIANT

Type number	Device marking	$V_z @ I_{ZT} (V)$			$Z_{ZT} (\Omega)$		$Z_{ZK} (\Omega)$		$I_R (\mu A) @ V_R$		Typical temperature coefficient @ $I_{ZTC}$ mV/°C		Test Current $I_{ZTC}$
		min.	typ.	max.	$I_{ZT} (mA)$	max.	$I_{ZK} (mA)$	max.	max	$V_R (V)$	Min	Max	mA
BZT52C30	WQ	28	30	32	2	80	0.5	300	0.1	21.0	24.4	29.4	2
BZT52C33	WR	31	33	35	2	80	0.5	325	0.1	23.1	27.4	33.4	2
BZT52C36	WS	34	36	38	2	90	0.5	350	0.1	25.2	30.4	37.4	2
BZT52C39	WT	37	39	41	2	130	0.5	350	0.1	27.3	33.4	41.2	2
BZT52C43	WU	40	43	46	5	100	1.0	750	0.1	32	37.6	46.6	2
BZT52C47	WV	44	47	50	5	100	1.0	750	0.1	35	42.0	51.8	2
BZT52C51	WW	48	51	54	2	180	0.5	400	0.05	35.7	46.6	57.2	2
BZT52C56	X1	53	56	59	2	200	1	1000	0.1	42	52.2	63.8	2
BZT52C62	5X2	58	62	66	2	215	0.5	450	0.05	43.4	58.8	71.6	2
BZT52C68	5X3	64	68	72	2	240	0.5	475	0.05	47.6	65.6	79.8	2
BZT52C75	5X4	70	75	79	2	255	0.5	500	0.05	52.5	73.4	88.6	2

## ■ Thermal Characteristics

Parameter	Symbol	Unit	Value
Thermal resistance, junction-to-ambient	$R_{\theta J-A}^{(1)}$	°C/W	250
Thermal resistance, junction-to-case	$R_{\theta J-C}^{(1)}$	°C/W	200

### Note:

(1) Thermal resistance from junction to ambient and from junction to case mounted on P.C.B. with 8mm\*9mm copper pad areas



# BZT52C2V4 THRU BZT52C75

RoHS  
COMPLIANT

## ■ Characteristics

Fig 1: P<sub>D</sub>-T<sub>a</sub> Curve

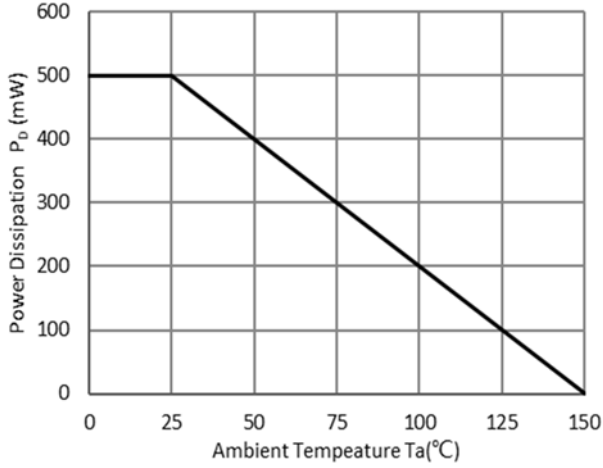

Fig 2: Zener Breakdown Characteristics

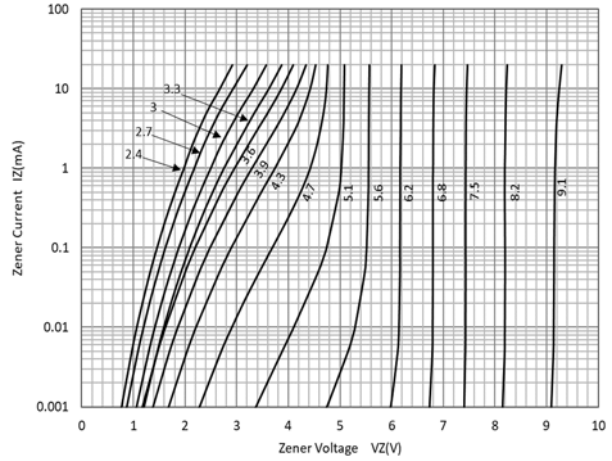

Fig 3: Zener Breakdown Characteristics

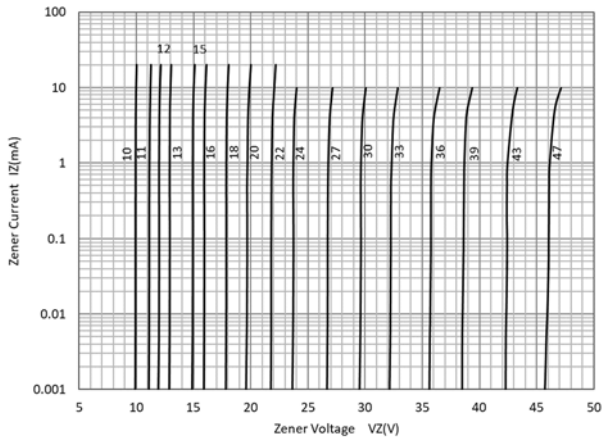

Fig 4: Zener Breakdown Characteristics

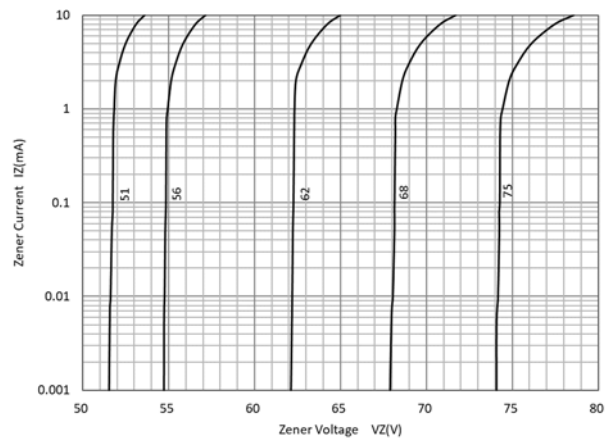

Fig 5: Typical Temperature Coefficient

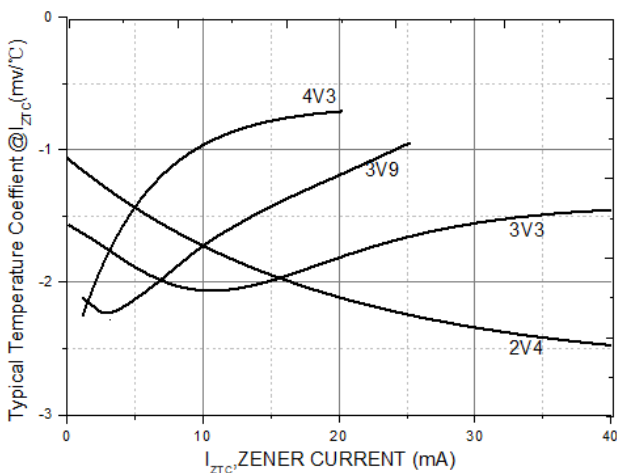
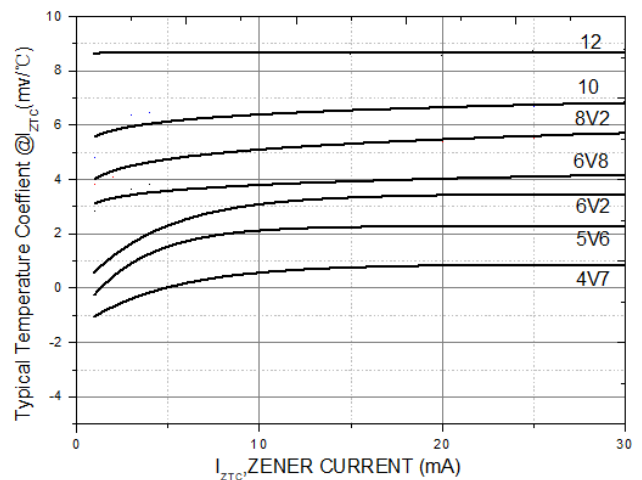

Fig 6: Typical Temperature Coefficient





# BZT52C2V4 THRU BZT52C75

RoHS  
COMPLIANT

## Ordering Information

Preferred P/N	Packing code	Unit weight(g)	Minimum package(pcs)	Inner box quantity(pcs)	Outer carton quantity(pcs)	Delivery mode
BZT52C2V4 THRU BZT52C75	F2	Approximate 0.011	3000	30000	120000	7" reel
BZT52C2V4 THRU BZT52C75	F3	Approximate 0.011	10000	/	210000	13" reel

## Outline Dimensions

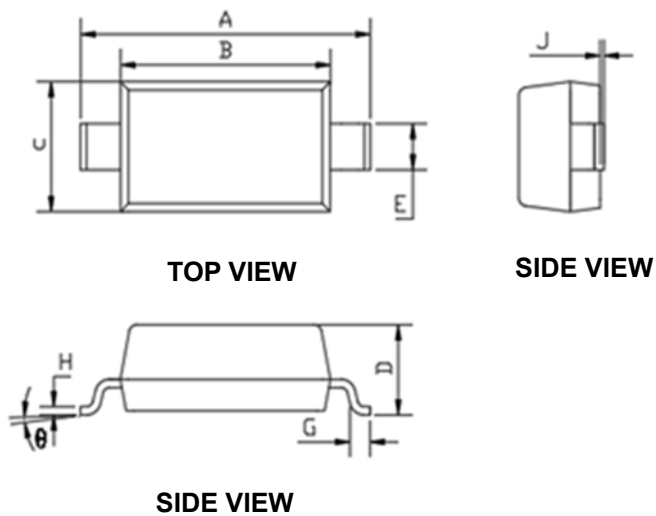

DIMENSIONS				
DIM	INCHES		MM	
	MIN	MAX	MM	MAX
A	0.140	0.152	3.550	3.850
B	0.100	0.112	2.550	2.850
C	0.055	0.071	1.400	1.800
D	0.037	0.053	0.950	1.350
E	0.020	0.028	0.510	0.710
G	0.006	0.018	0.150	0.450
H	0.003	0.010	0.080	0.250
J	0.000	0.006	0.000	0.150
$\theta$	0	8°	0	8°

## Suggested Pad Layout

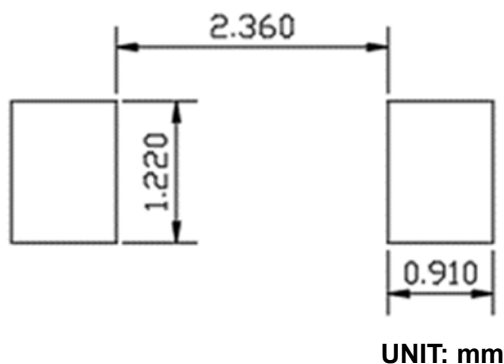



## BZT52C2V4 THRU BZT52C75

RoHS  
COMPLIANT

### Disclaimer

The information presented in this document is for reference only. Yangzhou Yangjie Electronic Technology Co., Ltd. reserves the right to make changes without notice for the specification of the products displayed herein to improve reliability, function, or design or otherwise.

The product listed herein is designed to be used with ordinary electronic equipment or devices, and not designed to be used with equipment or devices which require high level of reliability and the malfunction of which would directly endanger human life (such as medical instruments, transportation equipment, aerospace machinery, nuclear-reactor controllers, fuel controllers and other safety devices), Yangjie or anyone on its behalf, assumes no responsibility or liability for any damages resulting from such improper use of sale.

This publication supersedes & replaces all information previously supplied. For additional information, please visit our website [http:// www.21yangjie.com](http://www.21yangjie.com) , or consult your nearest Yangjie's sales office for further assistance.

单击下面可查看定价，库存，交付和生命周期等信息

[>>Yangjie\(扬杰\)](#)