

Zener Diodes

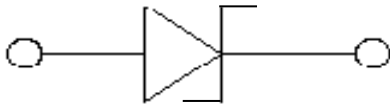

Features

- High reliability
- Very sharp reverse characteristic
- Low reverse current level
- Zener Voltage 2.4V~75V

Mechanical Data

- **Package:** SOD-323
- **Terminals:** Tin plated leads, solderable per J-STD-002 and JESD22-B102
- **Polarity:** Cathode line denotes the cathode end

■ Maximum Ratings (T_a=25°C Unless otherwise specified)

PARAMETER	SYMBOL	UNIT	VALUE
Power Dissipation (*Note)	P _D	mW	300
Storage Temperature Range	T _{stg}	°C	-55~+150
Junction Temperature	T _J	°C	-55~+150
Maximum Regulator Current	I _{ZM}	mA	P _D /V _Z
Maximum Forward Voltage (I _F =10mA _{dc})	V _F	V	0.9
Thermal Resistance Junction to Ambient Air(*Note)	R _{θJA}	°C/W	417

Note: Device mounted on PCB

■ Ordering Information (Example)

PREFERRED P/N	PACKING CODE	UNIT WEIGHT(g)	MINIMUM PACKAGE(pcs)	INNER BOX QUANTITY(pcs)	OUTER CARTON QUANTITY(pcs)	DELIVERY MODE
BZT52C2V4S THRU BZT52C75S	F2	Approximate 0.0048	3000	30000	120000	7" reel



BZT52C2V4S THRU BZT52C75S

■ Electrical Characteristics (T_a=25°C Unless otherwise specified)

Type Number	Device Marking	V _z at I _{zT} (V)			Z _{zT} (Ω)		Z _{zk} (Ω)		I _R (μA)@V _R		Typical Temperature Coefficient @I _{zTC}	
		min.	typ.	max.	I _{zT} (mA)	max.	I _{zk} (mA)	max.	max	V _R (V)	mV/°C	
BZT52C2V4S	WX	2.28	2.4	2.52	5	100	1.0	600	50	1.0	-3.5	0
BZT52C2V7S	W1	2.57	2.7	2.84	5	100	1.0	600	20	1.0	-3.5	0
BZT52C3V0S	W2	2.85	3.0	3.15	5	95	1.0	600	10	1.0	-3.5	0
BZT52C3V3S	W3	3.14	3.3	3.47	5	95	1.0	600	5	1.0	-3.5	0
BZT52C3V6S	W4	3.42	3.6	3.78	5	90	1.0	600	5	1.0	-3.5	0
BZT52C3V9S	W5	3.71	3.9	4.1	5	90	1.0	600	3	1.0	-3.5	0
BZT52C4V3S	W6	4.09	4.3	4.52	5	90	1.0	600	3	1.0	-3.5	0
BZT52C4V7S	W7	4.47	4.7	4.94	5	80	1.0	500	3	2.0	-3.5	0.2
BZT52C5V1S	W8	4.85	5.1	5.36	5	60	1.0	480	2	2.0	-2.7	1.2
BZT52C5V6S	W9	5.32	5.6	5.88	5	40	1.0	400	1	2.0	-2.0	2.5
BZT52C6V2S	WA	5.8	6.2	6.6	5	10	1.0	150	3	4.0	0.4	3.7
BZT52C6V8S	WB	6.4	6.8	7.2	5	15	1.0	80	2	4.0	1.2	4.5
BZT52C7V5S	WC	7.0	7.5	7.9	5	15	1.0	80	1	5.0	2.5	5.3
BZT52C8V2S	WD	7.7	8.2	8.7	5	15	1.0	80	0.7	5.0	3.2	6.2
BZT52C9V1S	WE	8.5	9.1	9.6	5	15	1.0	100	0.5	6.0	3.8	7.0
BZT52C10S	WF	9.4	10	10.6	5	20	1.0	150	0.2	7.0	4.5	8.0
BZT52C11S	WG	10.4	11	11.6	5	20	1.0	150	0.1	8.0	5.4	9.0
BZT52C12S	WH	11.4	12	12.7	5	25	1.0	150	0.1	8.0	6.0	10.0
BZT52C13S	WI	12.4	13	14.1	5	30	1.0	170	0.1	8.0	7.0	11.0
BZT52C15S	WJ	14.25	15	15.6	5	30	1.0	200	0.1	10.5	9.2	13.0
BZT52C16S	WK	15.3	16	17.1	5	40	1.0	200	0.1	11.2	10.4	14.0
BZT52C18S	WL	16.8	18	19.1	5	45	1.0	225	0.1	12.6	12.4	16.0
BZT52C20S	WM	18.8	20	21.2	5	55	1.0	225	0.1	14.0	14.4	18.0
BZT52C22S	WN	20.8	22	23.3	5	55	1.0	250	0.1	15.4	16.4	20.0
BZT52C24S	WO	22.8	24	25.6	5	70	1.0	250	0.1	16.8	18.4	22.0
BZT52C27S	WP	25.1	27	28.9	2	80	0.5	300	0.1	18.9	21.4	25.3
BZT52C30S	WQ	28	30	32	2	80	0.5	300	0.1	21.0	24.4	29.4
BZT52C33S	WR	31	33	35	2	80	0.5	325	0.1	23.1	27.4	33.4
BZT52C36S	WS	34	36	38	2	90	0.5	350	0.1	25.2	30.4	37.4
BZT52C39S	WT	37	39	41	2	130	0.5	350	0.1	27.3	33.4	41.2
BZT52C43S	WU	40	43	46	5	100	1.0	750	0.1	32	37.6	46.6
BZT52C47S	WV	44	47	50	5	100	1.0	750	0.1	35	42.0	51.8
BZT52C51S	X1	48	51	54	2	180	0.5	400	0.05	35.7	46.6	57.2
BZT52C56S	X2	53	56	59	2	200	1	1000	0.1	42	52.2	63.8
BZT52C62S	X3	58	62	66	2	215	0.5	450	0.05	43.4	58.8	71.6
BZT52C68S	X4	64	68	72	2	240	0.5	475	0.05	47.6	65.6	79.8
BZT52C75S	X5	70	75	79	2	255	0.5	500	0.05	52.5	73.4	88.6



BZT52C2V4S THRU BZT52C75S

■ Characteristics (Typical)

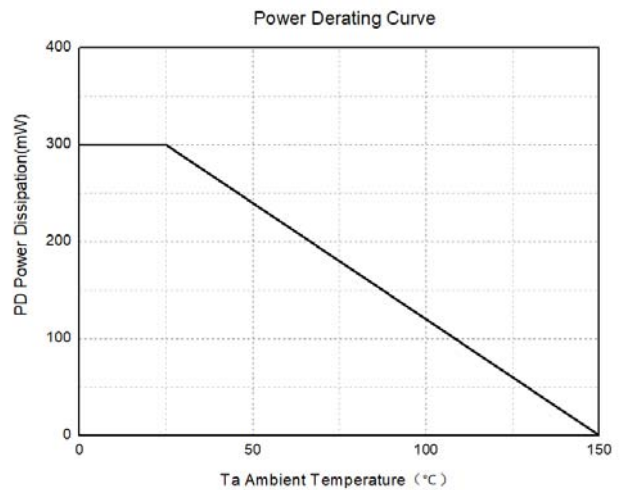
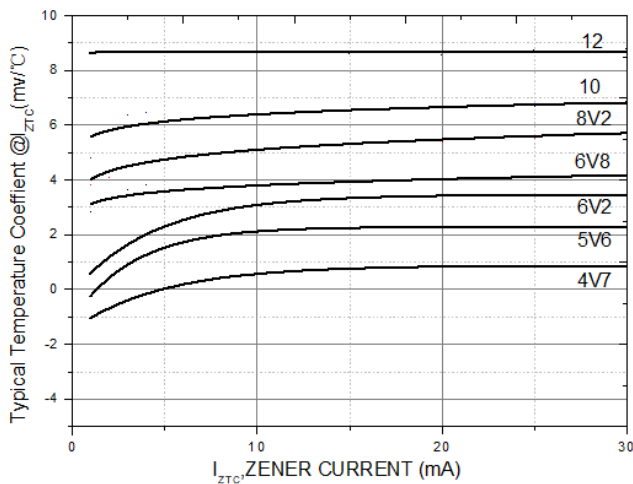
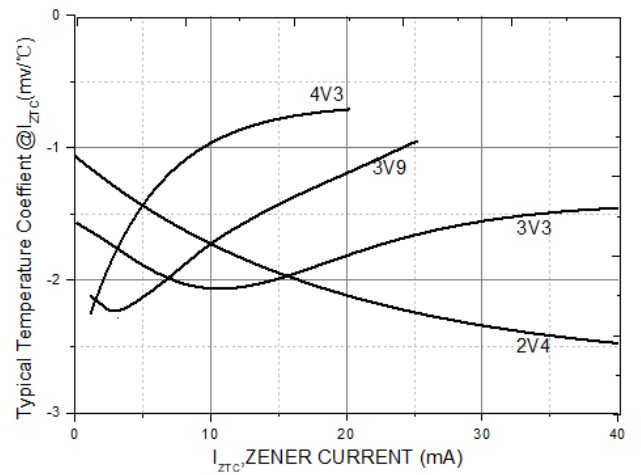
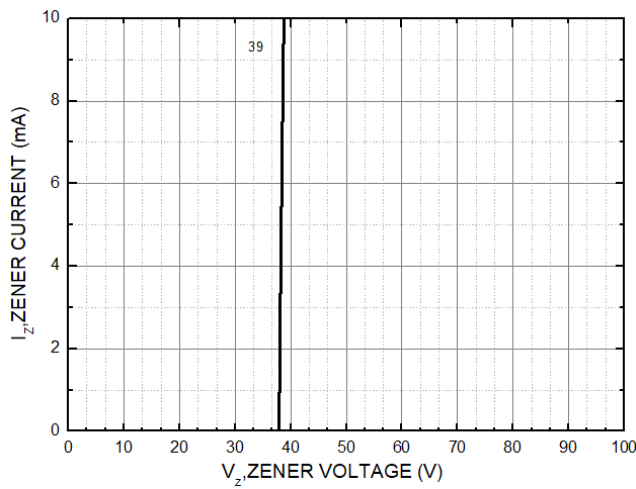
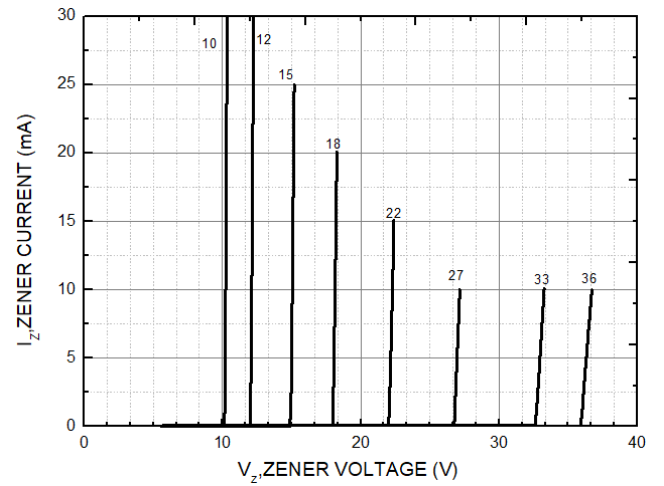
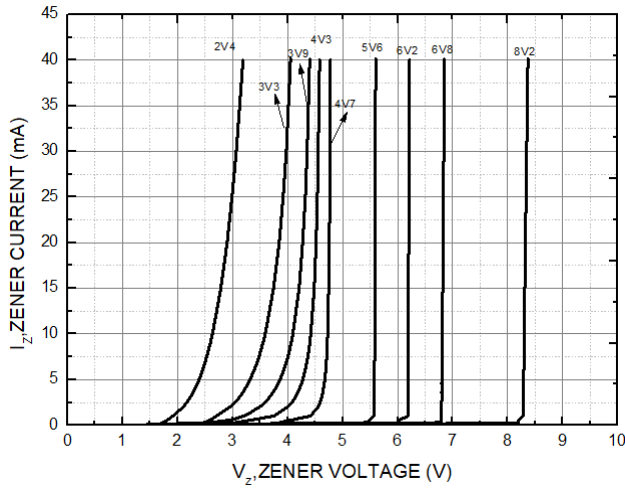



BZT52C2V4S THRU BZT52C75S

■Outline Dimensions

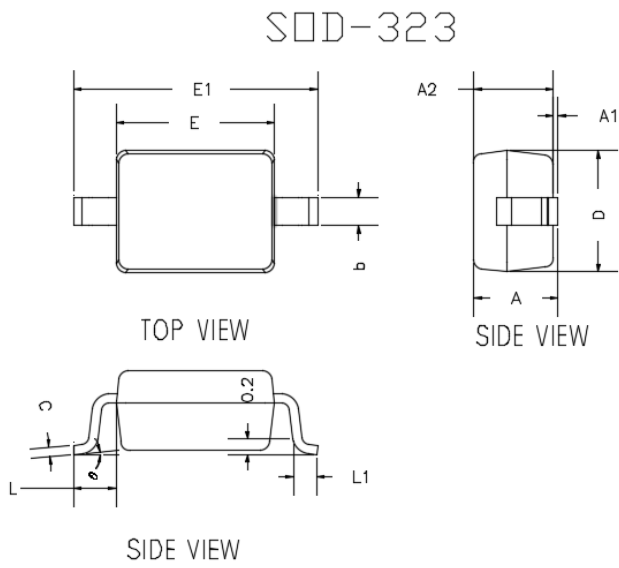

DIMENSIONS				
DIM	INCHES		MM	
	MIN	MAX	MIN	MAX
A	---	0.0393	---	1.0000
A1	0.0000	0.0039	0.0000	0.1000
A2	0.0314	0.0354	0.8000	0.9000
b	0.0098	0.0157	0.2500	0.4000
c	0.0031	0.0059	0.0800	0.1500
D	0.0472	0.0551	1.2000	1.4000
E	0.0629	0.0709	1.6000	1.8000
E1	0.0984	0.1063	2.5000	2.7000
L	0.0187TYP		0.475TYP	
L1	0.0098	0.0157	0.250	0.400
e	0°	8°	0°	8°

■Soldering Footprint

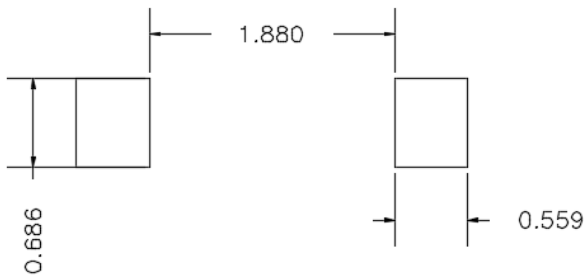

UNIT : mm

SUGGESTED SOLDER PAD LAYOUT



BZT52C2V4S THRU BZT52C75S

Disclaimer

The information presented in this document is for reference only. Yangzhou Yangjie Electronic Technology Co., Ltd. reserves the right to make changes without notice for the specification of the products displayed herein to improve reliability, function or design or otherwise.

The product listed herein is designed to be used with ordinary electronic equipment or devices, and not designed to be used with equipment or devices which require high level of reliability and the malfunction of which would directly endanger human life (such as medical instruments, transportation equipment, aerospace machinery, nuclear-reactor controllers, fuel controllers and other safety devices), Yangjie or anyone on its behalf, assumes no responsibility or liability for any damages resulting from such improper use of sale.

This publication supersedes & replaces all information previously supplied. For additional information, please visit our website [http:// www.21yangjie.com](http://www.21yangjie.com) , or consult your nearest Yangjie's sales office for further assistance.

单击下面可查看定价，库存，交付和生命周期等信息

[>>Yangjie\(扬杰\)](#)