

SCHOTTKY BARRIER RECTIFIER

Reverse Voltage - 100 V

Forward Current - 10 A

FEATURES

- ◆ Very low forward voltage
- ◆ High current capability
- ◆ High forward surge capability
- ◆ Low power losses, High efficiency
- ◆ Guarding for over voltage protection
- ◆ Lead free in comply with EU RoHS 2011/65/EU directives

MECHANICAL DATA

- ◆ Case: TO-220AB/CT TO-220F/FCT TO-263/DC TO-252/CS
- ◆ Solder bath temperature 275°C maximum, 10s per JESD22-106

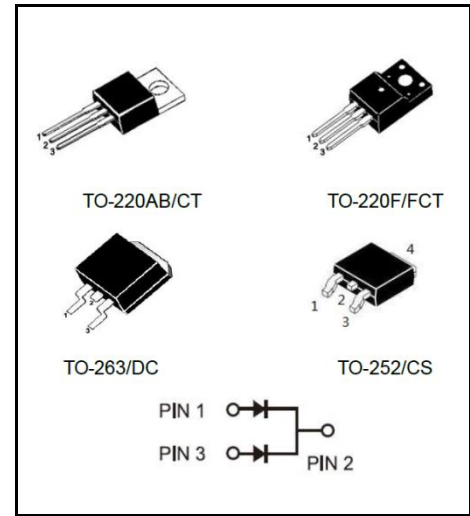

Primary Characteristic

I_o	2*5A
V_{RRM}	100V
I_{FSM}	200A
V_F	0.65V
T_J Max	150°C

Maximum Ratings (Per Leg) at $T_a=25^\circ\text{C}$ unless otherwise specified

Parameter	Symbols	Value	Units
Maximum Repetitive Peak Reverse Voltage	V_{RRM}	100	V
Maximum RMS voltage	V_{RMS}	70	V
Maximum DC Blocking Voltage	V_{DC}	100	V
Maximum Average Forward Rectified Current	Per Leg	5	A
	Total	10	
Peak Forward Surge Current, 8.3ms Single Half Sine-wave	I_{FSM}	200	A
Operating Temperature Range	T_J	-55 ~ +150	°C
Storage Temperature Range	T_{STG}	-55 ~ +150	°C
Typical Thermal Resistance ^(Note1) TO-220AB, TO-263 TO-220F TO252	$R_{\theta JA}$ $R_{\theta JC}$	2/4	°C/W

Note1: Thermal resistance from Junction to case per leg mounted on heatsink.

Electrical Characteristics (Per Leg) unless otherwise specified

Characteristics	Symbols	Value		Units	
		Typ	Max		
Forward Voltage Drop(Note2) at $I_F=2A$ at $I_F=3A$ at $I_F=5A$	V_F	TA=25°C	0.68	-	V
		TA=125°C	0.56	-	
		TA=25°C	0.72	-	
		TA=125°C	0.60	-	
		TA=25°C	0.76	0.85	
		TA=125°C	0.65	-	
Maximum Reverse Current at $V_R=100V$	I_R	TA=25°C	1	5	uA
		TA=125°C	0.6	-	mA

Note2: Pulse test: 300 μs pulse width, 1 % duty cycle

RATINGS AND CHARACTERISTIC CURVES

FIG. 1 MAXIMUM FORWARD CURRENT DERATING CURVE

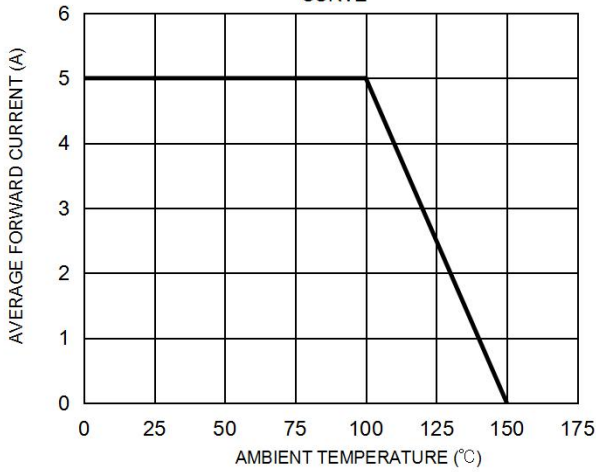

FIG. 2 MAXIMUM NON-REPETITIVE FORWARD SURGE CURRENT PER LEG

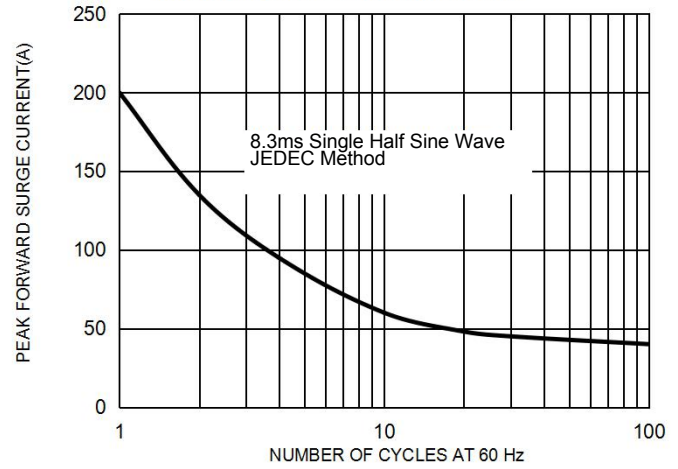

FIG. 3 TYPICAL FORWARD CHARACTERISTICS PER LEG

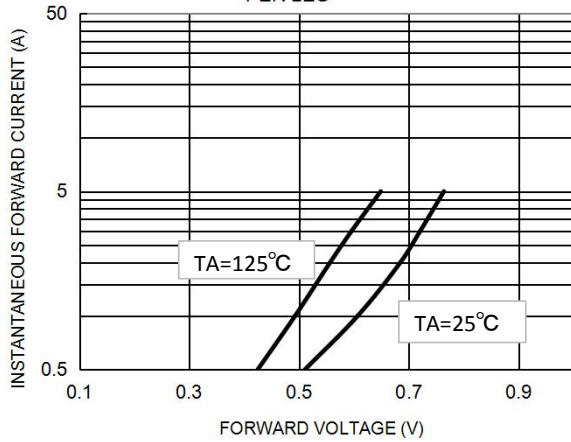
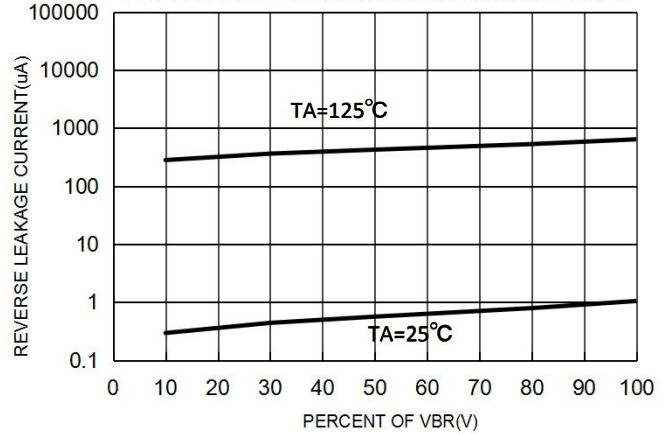
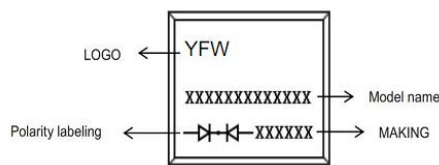

FIG. 4 TYPICAL REVERSE CHARACTERISTICS PER LEG



Marking on the body



MAKING:

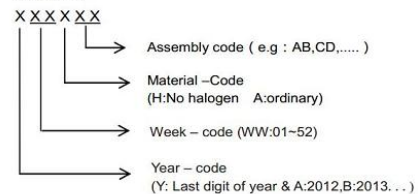

Ordering information

Part Number	Package	Unit Weight	Base Quantity	Delivery mode
MBR10100CT	TO-220AB	0.07oz(1.96g)	50 pcs / tube	1000pcs/box 5000pcs/carton
MBR10100FCT	TO-220F	0.06oz(1.74g)	50 pcs / tube	1000pcs/box 5000pcs/carton
MBR10100DC-G	TO-263	0.04oz(1.16g)	50 pcs / tube	1000pcs/box 5000pcs/carton
MBR10100DC	TO-263	0.04oz(1.16g)	800 pcs / reel	1600pcs/box 4000pcs/carton
MBR10100CS	TO-252	0.011oz(0.32g)	2500 pcs / reel	5000pcs/box 12500pcs/carton

Note: For Halogen Free molding compound, add "H" suffix to part number above.

TO-220AB

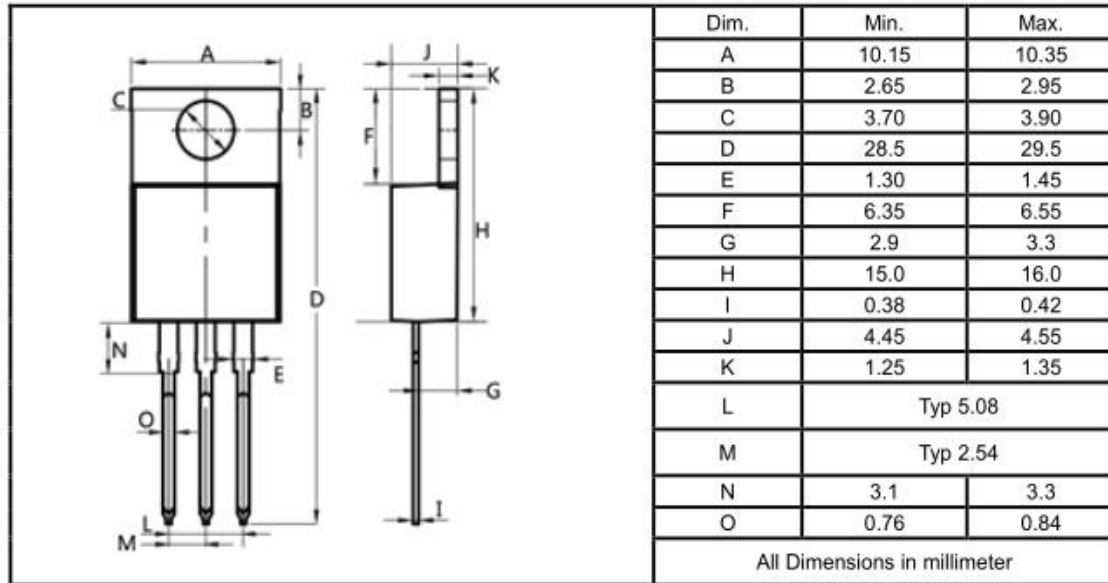

TO-220F

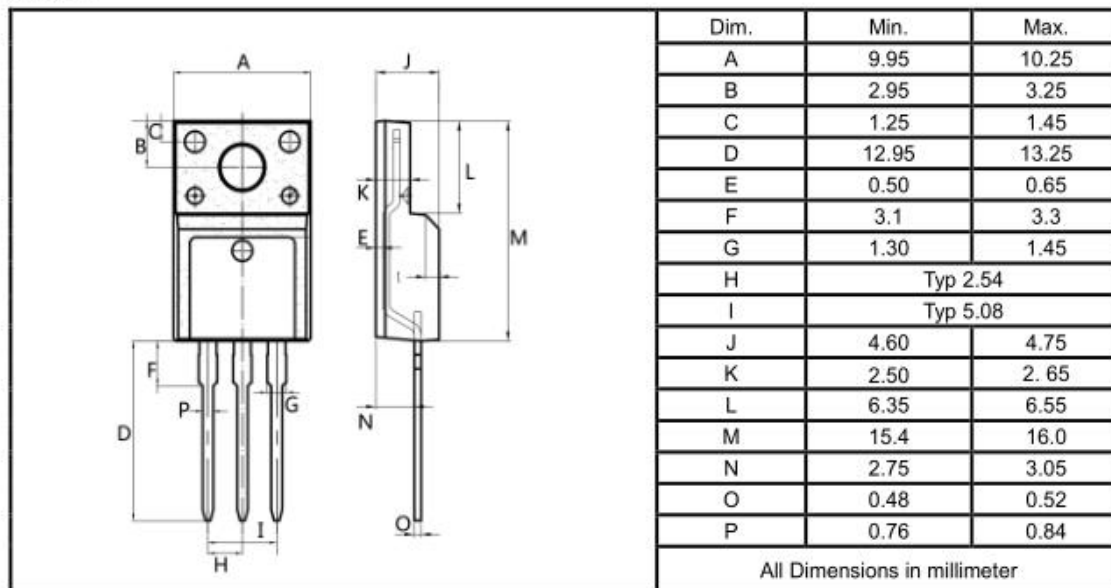

TO-263

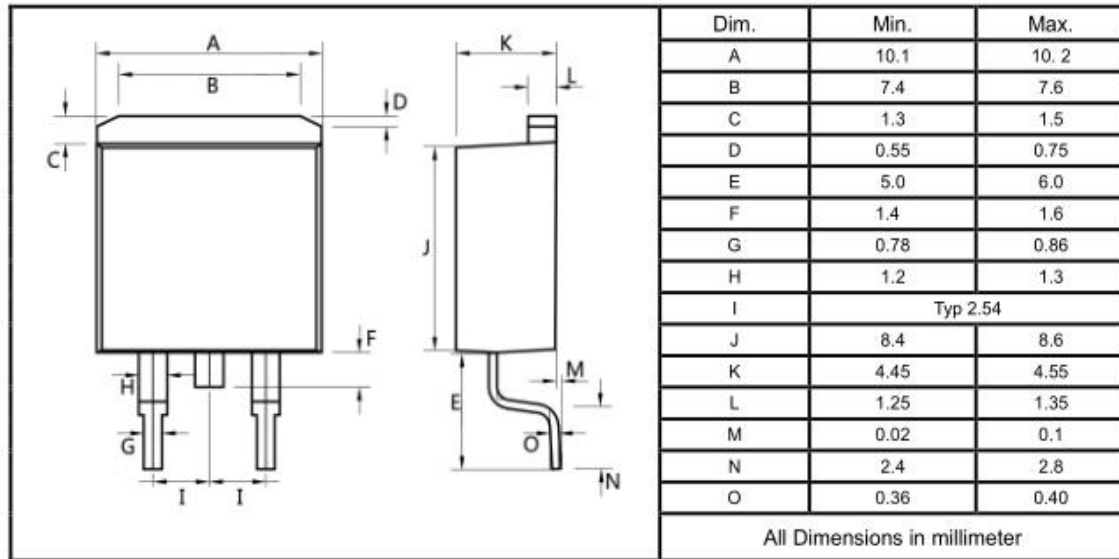

TO-252

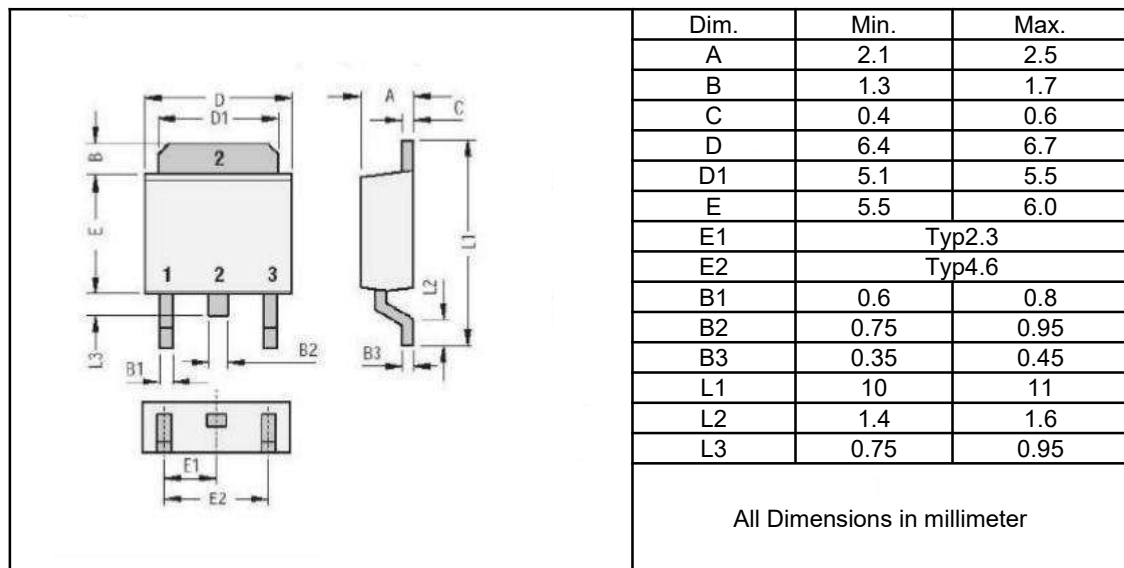

单击下面可查看定价，库存，交付和生命周期等信息

[>>YFW\(佑风微\)](#)