

Surface Mount Superfast Recovery Rectifier

Reverse Voltage - 50 to 600 V

Forward Current - 8 A

FEATURES

- ◆ Glass Passivated Chip Junction
- ◆ For surface mounted applications
- ◆ Low profile package
- ◆ Superfast reverse recovery time
- ◆ Lead free in comply with EU RoHS 2011/65/EU directives

MECHANICAL DATA

- ◆ Case: DO-214AB/SMC
- ◆ Terminals: Solderable per MIL-STD-750, Method 2026
- ◆ Approx. Weight: 0.22g / 0.0077oz

Pinning

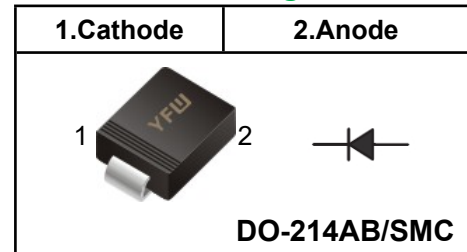

Marking Code

ES8AC	ES8A
ES8BC	ES8B
ES8DC	ES8D
ES8GC	ES8G
ES8JC	ES8J

Absolute Maximum Ratings and characteristics

Ratings at 25 °C ambient temperature unless otherwise specified.

Single phase half-wave 60 Hz, resistive or inductive load, for capacitive load current derate by 20 %.

Parameter	Symbols	ES8AC	ES8BC	ES8DC	ES8GC	ES8JC	Units
Maximum Repetitive Peak Reverse Voltage	V_{RRM}	50	100	200	400	600	V
Maximum RMS voltage	V_{RMS}	35	70	140	280	420	V
Maximum DC Blocking Voltage	V_{DC}	50	100	200	400	600	V
Maximum Average Forward Rectified Current at $T_c = 125\text{ }^\circ\text{C}$	$I_{F(AV)}$	8					A
Peak Forward Surge Current 8.3 ms Single Half Sine Wave Superimposed on Rated Load	I_{FSM}	125					A
Maximum Instantaneous Forward Voltage at 8 A	V_F	0.95		1.25		1.65	V
Maximum DC Reverse Current $T_a = 25\text{ }^\circ\text{C}$ at Rated DC Blocking Voltage $T_a = 125\text{ }^\circ\text{C}$	I_R	10 350					μA
Typical Junction Capacitance at $V_R=4\text{V}, f=1\text{MHz}$	C_j	90					pF
Maximum Reverse Recovery Time ⁽¹⁾	T_{rr}	35					nS
Typical Thermal Resistance ⁽²⁾	$R_{\theta JA} / R_{\theta JC}$	75/20					$^\circ\text{C/W}$
Operating and Storage Temperature Range	T_j, T_{stg}	-55 ~ +150					$^\circ\text{C}$

(1) Measured with $I_F=0.5\text{A}, I_R=1\text{A}, I_n=0.25\text{A}$

(2) P.C.B. mounted with 2.0" X 2.0" (5 X 5 cm) copper pad areas.

Fig.1 Reverse Recovery Time Characteristic And Test Circuit Diagram

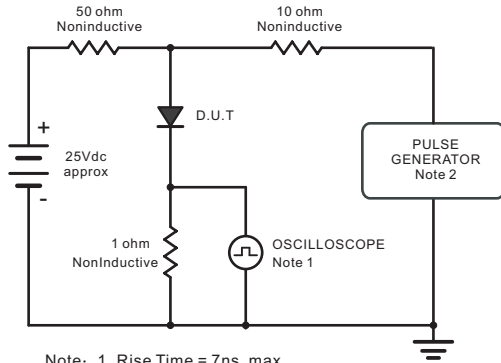

Note: 1. Rise Time = 7ns, max.
Input Impedance = 1megohm, 22pF.
2. Rises Time = 10ns, max.
Source Impedance = 50 ohms.

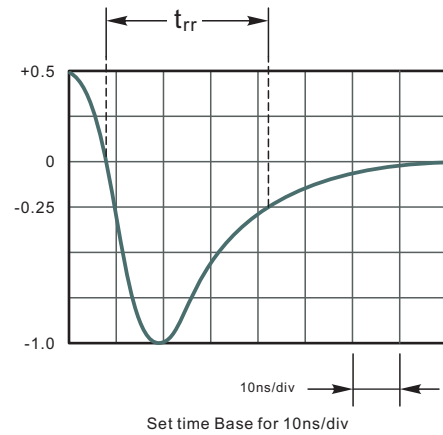

Fig.2 Maximum Average Forward Current Rating

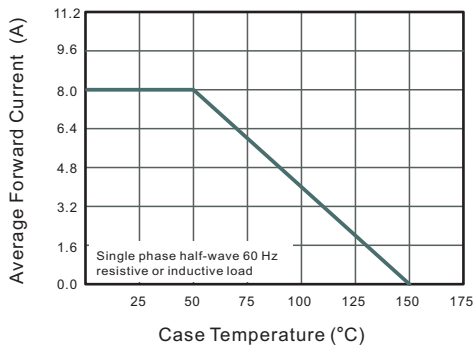

Fig.3 Typical Reverse Characteristics

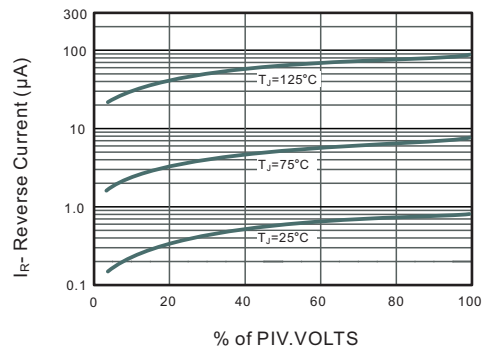

Fig.4 Typical Forward Characteristics

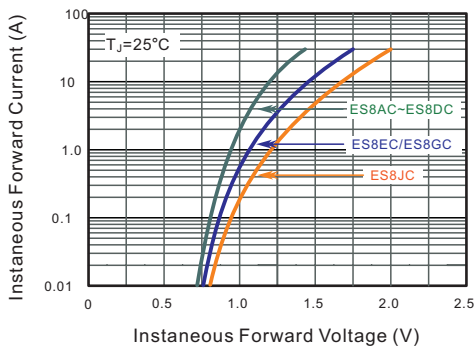

Fig.5 Typical Junction Capacitance

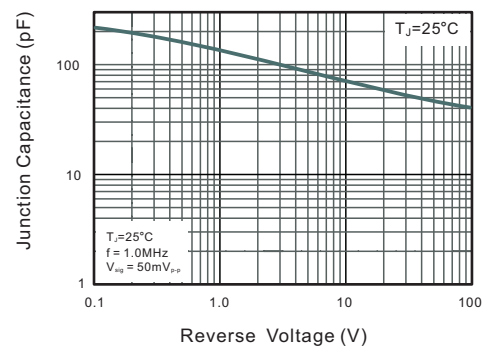
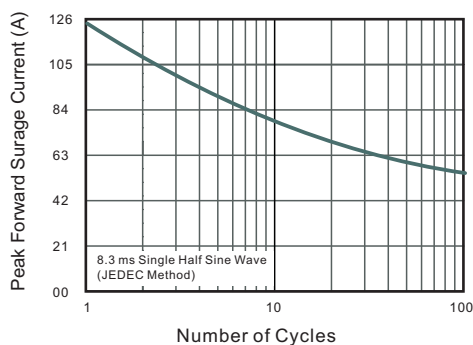
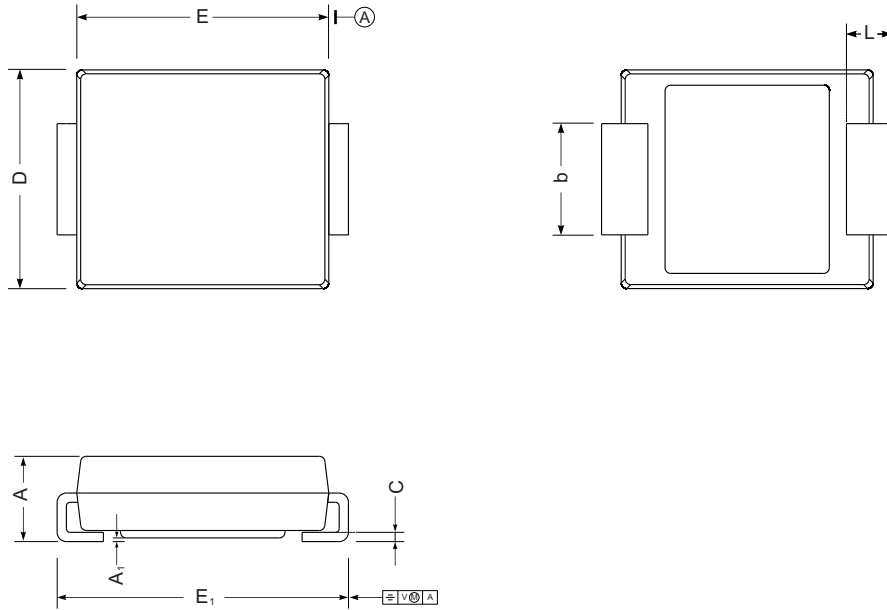

Fig.6 Maximum Non-Repetitive Peak Forward Surge Current



Package Outline DO-214AB SMC

Plastic surface mounted package; 2 leads



UNIT		A	E	D	E ₁	A ₁	C	L	b
mm	max	2.62	7.0	6.2	8.0	0.21	0.31	1.6	3.25
	min	2.00	6.5	5.6	7.6	0.05	0.15	0.9	2.75
mil	max	103	276	244	315	8.3	12	63	128
	min	79	256	220	299	2.0	5.9	35	108

The recommended mounting pad size

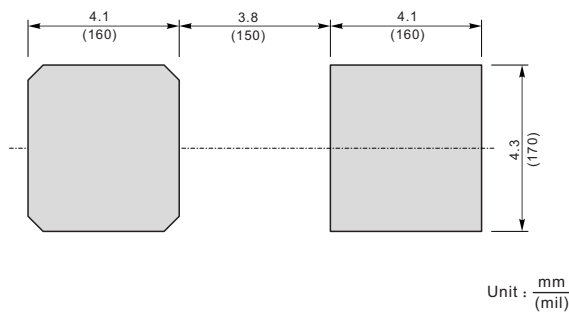

Summary of Packing Options

Package	Packing Description	Packing Quantity	Industry Standard
DO-214AB SMC	Tape/Reel, 13" reel	3000	EIA-481-1

单击下面可查看定价，库存，交付和生命周期等信息

[>>YFW\(佑风微\)](#)