

Surface Mount Schottky Barrier Rectifier

Reverse Voltage - 20 to 200 V

Forward Current - 2 A

FEATURES

- ◆ Metal silicon junction, majority carrier conduction
- ◆ For surface mounted applications
- ◆ Low power loss, high efficiency
- ◆ High forward surge current capability
- ◆ For use in low voltage, high frequency inverters, free wheeling, and polarity protection applications
- ◆ Lead free in comply with EU RoHS 2011/65/EU directives

MECHANICAL DATA

- ◆ Case: DO-214AA/SMB
- ◆ Terminals: Solderable per MIL-STD-750, Method 2026
- ◆ Approx. Weight: 0.095g / 0.003oz

Absolute Maximum Ratings and Electrical characteristics

Ratings at 25 ° ambient temperature unless otherwise specified. Single phase, half wave, 60Hz resistive or inductive load, for capacitive load, derate by 20 %

Pinning

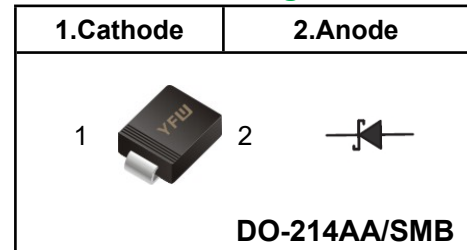

Marking Code

SS22B	SS22
SS24B	SS24
SS26B	SS26
SS28B	SS28
SS210B	SS210
SS212B	SS212
SS215B	SS215
SS220B	SS220

Parameter	Symbols	SS22B	SS24B	SS26B	SS28B	SS210B	SS212B	SS215B	SS220B	Units
Maximum Repetitive Peak Reverse Voltage	V_{RRM}	20	40	60	80	100	120	150	200	V
Maximum RMS voltage	V_{RMS}	14	28	42	56	70	84	105	140	V
Maximum DC Blocking Voltage	V_{DC}	20	40	60	80	100	120	150	200	V
Maximum Average Forward Rectified Current	$I_{F(AV)}$	2.0								A
Peak Forward Surge Current, 8.3ms Single Half Sine-wave Superimposed On Rated Load (JEDEC method)	I_{FSM}	55				45				A
Maximum Instantaneous Forward Voltage at 2 A	V_F	0.55		0.70		0.85		0.90		V
Maximum Instantaneous Reverse Current at Rated DC Reverse Voltage <small>$T_A = 25^{\circ}C$ $T_A = 100^{\circ}C$</small>	I_R	0.5 5			0.3 3					mA
Typical Junction Capacitance ⁽¹⁾	C_j	220				110				pF
Typical Thermal Resistance ⁽²⁾	$R_{\theta JA}$	60								°C/W
Operating Junction Temperature Range	T_j	-55 ~ +150								°C
Storage Temperature Range	T_{stg}	-55 ~ +150								°C

(1) Measured at 1 MHz and applied reverse voltage of 4 V D.C

(2) P.C.B. mounted with 2.0" X 2.0" (5 X 5 cm) copper pad areas.

Fig.1 Forward Current Derating Curve

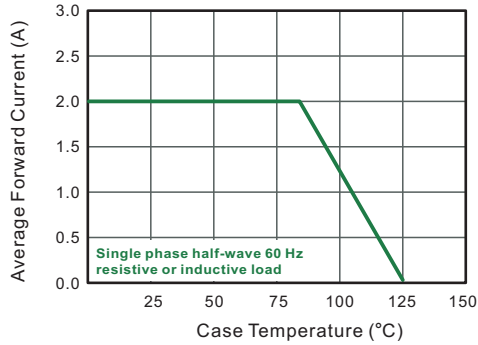

Fig.2 Typical Reverse Characteristics

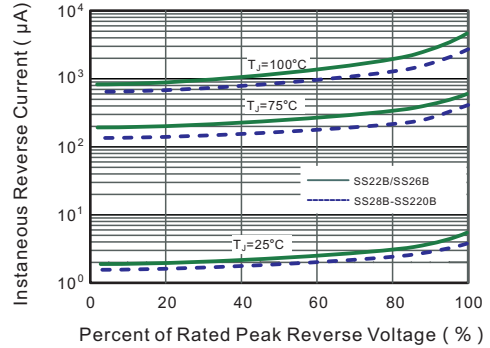

Fig.3 Typical Forward Characteristic

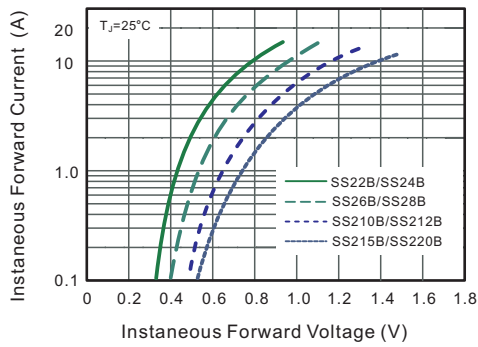

Fig.4 Typical Junction Capacitance

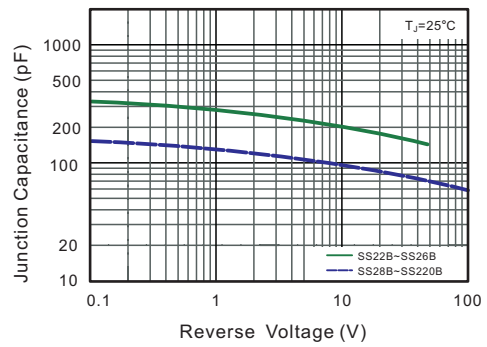

Fig.5 Maximum Non-Repetitive Forward Surge Current

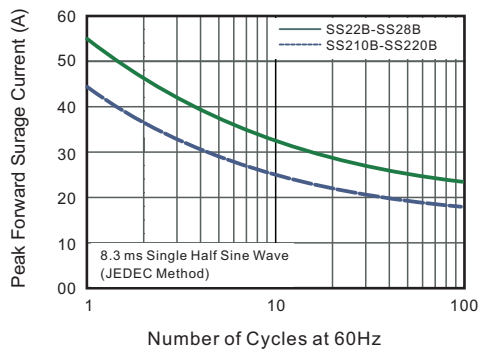
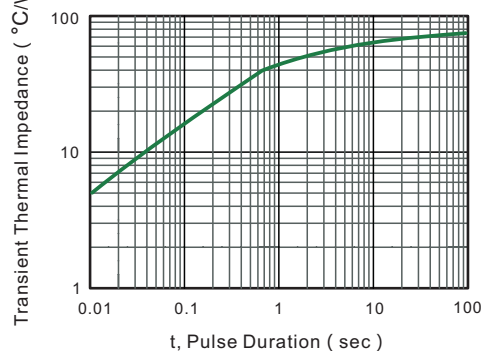
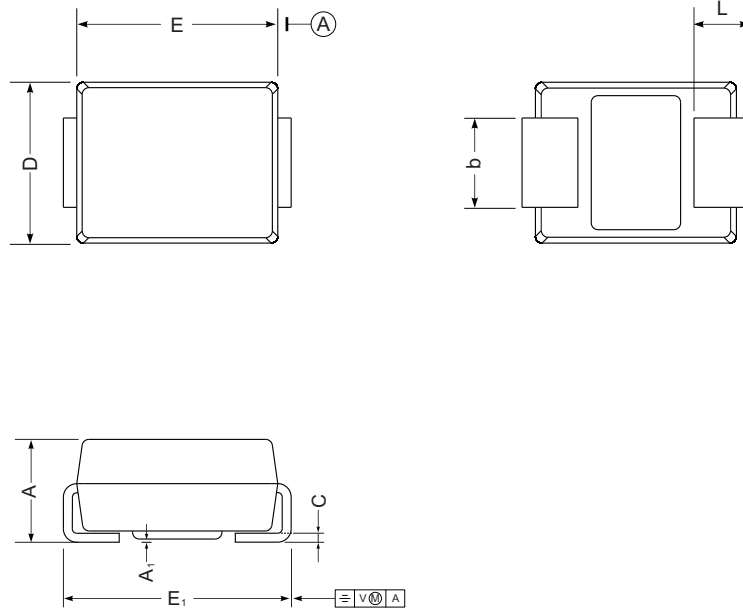

Fig.6- Typical Transient Thermal Impedance



Package Outline DO-214AA SMB

Plastic surface mounted package; 2 leads



UNIT		A	E	D	E ₁	A ₁	L	C	b
mm	max	2.44	4.70	3.94	5.59	0.20	1.5	0.305	2.2
	min	2.13	4.06	3.3	5.08	0.05	0.8	0.152	1.9
mil	max	96	185	155	220	7.9	59	12	87
	min	84	160	130	200	2.0	32	6	75

The recommended mounting pad size

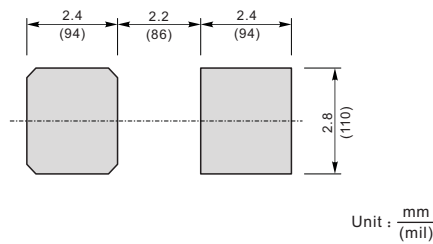

Summary of Packing Options

Package	Packing Description	Packing Quantity	Industry Standard
DO-214AA SMB	Tape/Reel, 13" reel	3000	EIA-481-1

单击下面可查看定价，库存，交付和生命周期等信息

[>>YFW\(佑风微\)](#)