

**Super Fast Rectifiers**

**Reverse Voltage - 600V**

**Forward Current - 20A**

**FEATURES**

- Glass passivated chip junctions
- Super fast recovery time for switching mode application
- High Forward Surge Capability
- Low Reverse Current
- Lead free in compliance with EU RoHS 2011/65/EU directive

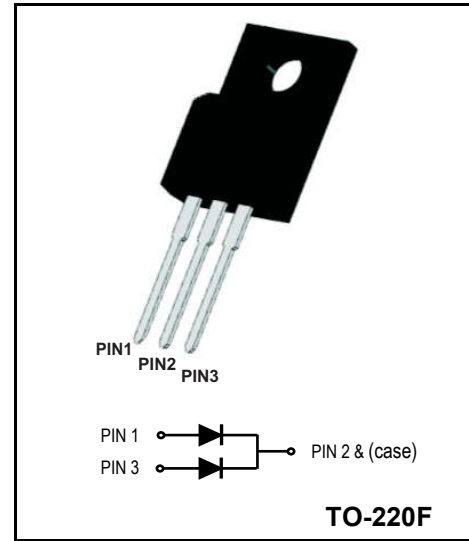

**MECHANICAL DATA**

- Circuit figure: Common Cathode
- Leads: Solderable per mil-std-202, Method 208
- Polarity: as marked
- Mounting torque: 5 in-lbs maximum
- Terminals: Puretin plated
- Weight: TO-220F 1.70 grams

**MAXIMUM RATINGS AND ELECTRICAL CHARACTERISTICS (TA=25°C)**

RATINGS	SYMBOL	Value	Units
Maximum repetitive reverse voltage	$V_{RRM}$	600	V
Maximum RMS voltage	$V_{RMS}$	420	V
Maximum DC blocking voltage	$V_{DC}$	600	V
Maximum average forward current	$I_{AV}$	20	A
Peak forward surge current, 8.3ms single half sine-wave superimposed on rated load	$I_{FSM}$	300	A
Typical thermal resistance per diode (Note 1)	$R_{\theta-JC}$	4.0	°C/W
Operation Junction Temperature and Storage Temperature	$T_J, T_{STG}$	-55 ~ +150	°C
<b>CHARACTERISTICS</b>			
Typical forward voltage per leg at 10A	$V_F$	1.65	V
Maximum average reverse current at rated DC blocking voltage	$I_R$	5 250	$\mu A$
Typical reverse recovery time (Note 2)	$T_{RR}$	35	nS

Notes: 1. Thermal resistance from junction to case.  
2. Test conditions:  $I_F=0.5A, I_R=1.0A, I_{RR}=0.25A.$

**Ratings And Characteristic Curves**

FIG. 1 - TYPICAL FORWARD CURRENT DERATING CURVE

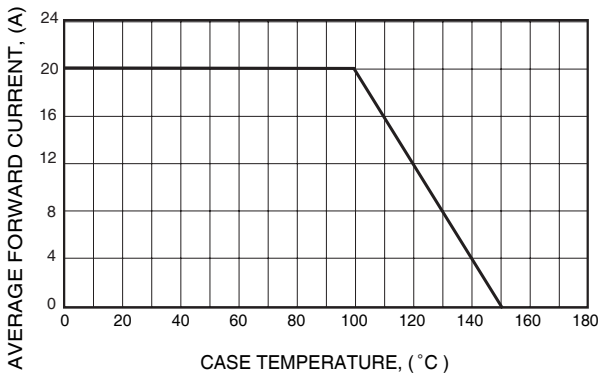

FIG. 3 - MAXIMUM NON-REPETITIVE FORWARD SURGE CURRENT

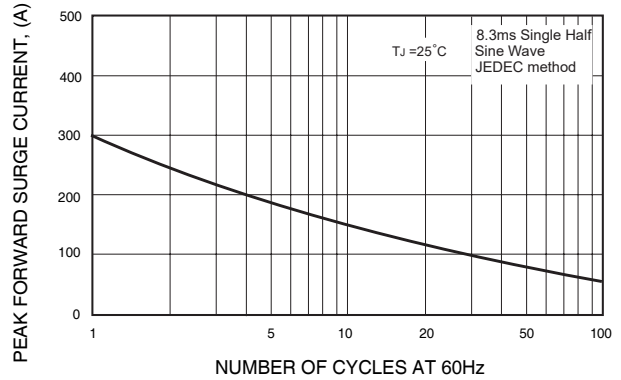

FIG. 4 - TYPICAL REVERSE CHARACTERISTICS

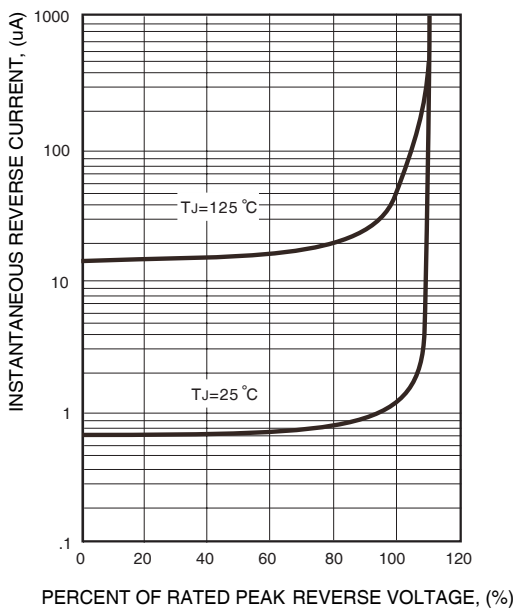

FIG. 2 - TYPICAL INSTANTANEOUS FORWARD CHARACTERISTICS

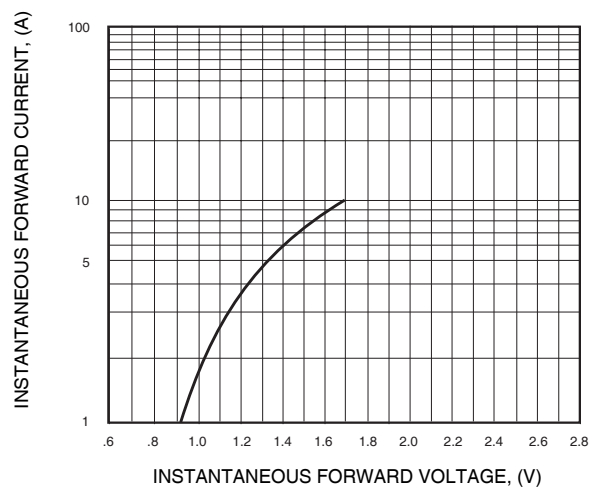
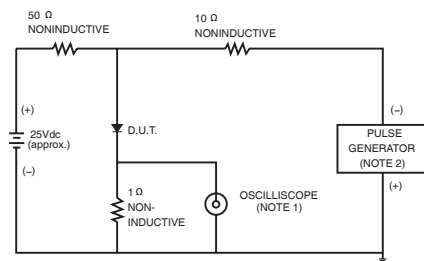
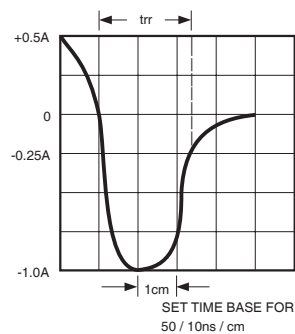

FIG. 6- TEST CIRCUIT DIAGRAM AND REVERSE RECOVERY TIME CHARACTERISTICS



NOTES: 1. Rise Time= 7ns max., Input Impedance= 1 megohm, 22pF.  
2. Rise Time= 10ns max., Source Impedance= 50 ohms.



Package Outline Dimensions Millimeters

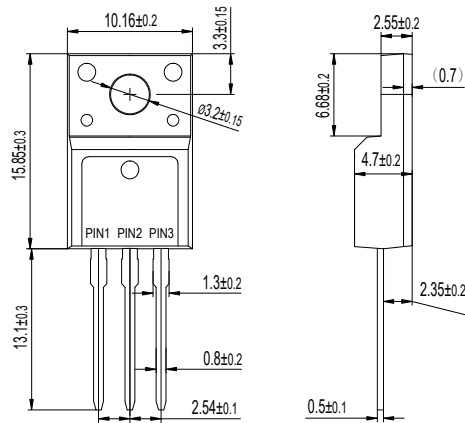

单击下面可查看定价，库存，交付和生命周期等信息

[>>YFW\(佑风微\)](#)