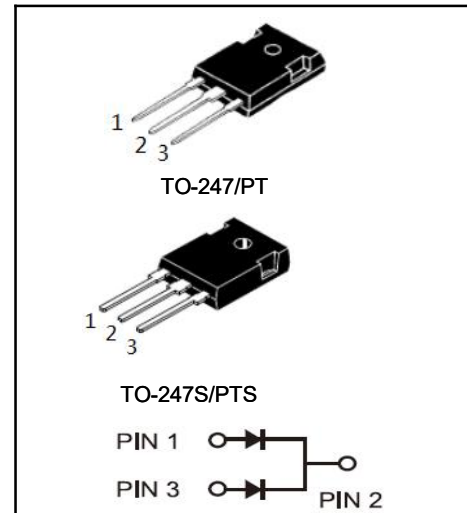

ULTRA LOW VF SCHOTTKY RECTIFIER
Reverse Voltage - 150 V
Forward Current - 40 A
FEATURES

- ◆ Ultra low forward voltage
- ◆ High current capability
- ◆ High forward surge capability
- ◆ Low power losses, High efficiency
- ◆ Guarding for over voltage protection

MECHANICAL DATA

- ◆ Case: Molded plastic
- ◆ Polarity: As marked
- ◆ Mounting Position: Any
- ◆ Molded Plastic: UL Flammability Classification Rating 94V-0
- ◆ Lead free in compliance with EU RoHS 2011/65/EU directive
- ◆ Solder bath temperature 275°C maximum, 10s per JESD 22-B106

Primary Characteristic

I_o	2*20A
V_{RRM}	150V
I_{FSM}	300A
V_F	0.70V
T_{Jmax}	150°C

Maximum Ratings at Ta=25°C unless otherwise specified

Characteristics	Symbol	Value	Unit
Maximum Repetitive Peak Reverse Voltage	V_{RRM}	150	V
Working Peak Reverse Voltage	V_{RWM}	105	V
Maximum DC Blocking Voltage	V_{DC}	150	V
Maximum Average Forward Rectified Current	Per Leg Total	I_o	20
			40
Peak Forward Surge Current, 8.3 ms Single Half Sine-wave Superimposed on Rated Load (JEDEC method)	I_{FSM}	300	A
Operating Temperature Range	T_J	-50 to +150	°C
Storage Temperature Range	T_{STG}	-50 to +150	°C
Typical Thermal Resistance (Note1)	$R_{\theta JC}$	2	°C/W

Note1: Thermal resistance from Junction to case per leg mounted on heatsink.

Electrical Characteristics unless otherwise specified

Characteristics	Symbol	Value		Unit
Forward Voltage Drop(Note2)		Typ.	Max.	V
at $I_F=5A$		TA=25°C	0.57	-
		TA=125°C	0.5	-
at $I_F=10A$		TA=25°C	0.73	-
		TA=125°C	0.6	-
at $I_F=20A$		TA=25°C	1.02	1.2
		TA=125°C	0.7	-
Maximum Reverse Current at $V_R=150V$		TA=25°C	5	20
		TA=125°C	5	-
				μA
				mA

Note2: Pulse test: 300 μs pulse width, 1 % duty cycle

RATINGS AND CHARACTERISTIC CURVES

FIG.1 MAXIMUM FORWARD CURRENT DERATING CURVE

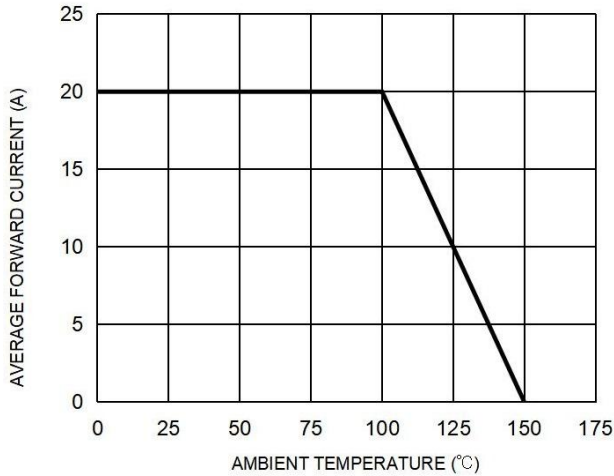

FIG. 2 MAXIMUM NON-REPETITIVE FORWARD SURGE CURRENT PER LEG

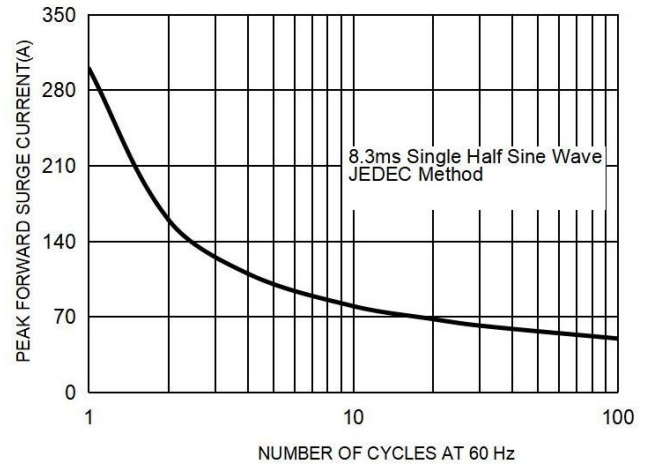

FIG. 3 TYPICAL FORWARD CHARACTERISTICS PER LEG

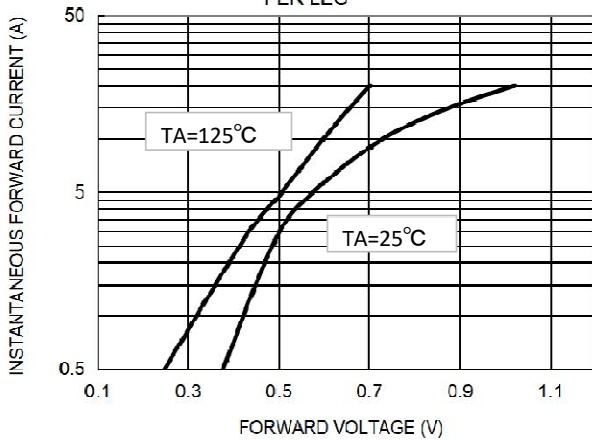
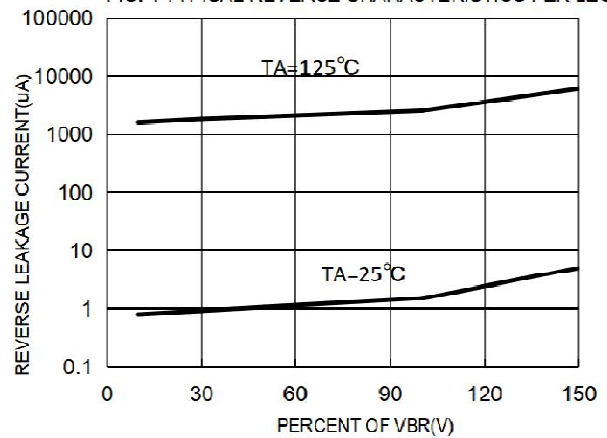
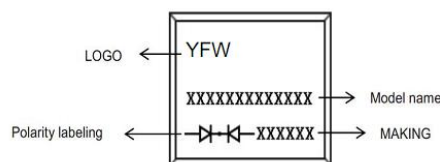

FIG. 4 TYPICAL REVERSE CHARACTERISTICS PER LEG



Marking on the body



MAKING:

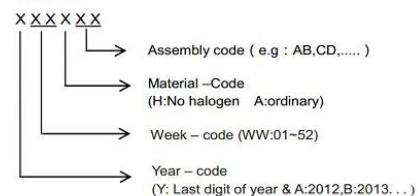

Ordering information

Part Number	Package	Unit Weight	Base Quantity	Delivery mode
SRT40U150PT	TO-247	0.209oz(5.93g)	30 pcs / tube	600pcs/box 2400pcs/carton
SRT40U150PTS	TO-247S	0.158oz(4.48g)	30 pcs / tube	600pcs/box 2400pcs/carton

Note: For Halogen Free molding compound, add "H" suffix to part number above.

Package Outline Dimensions millimeters

TO-247

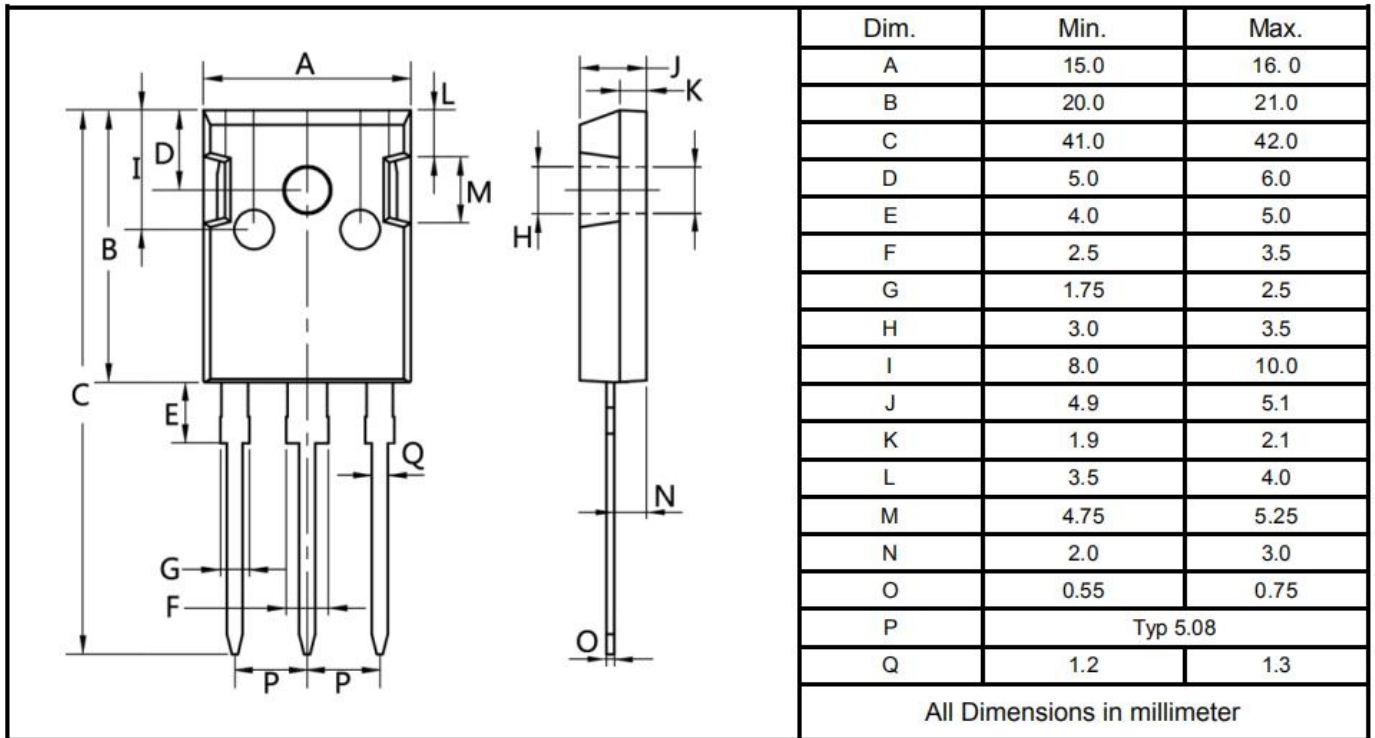

TO-247S

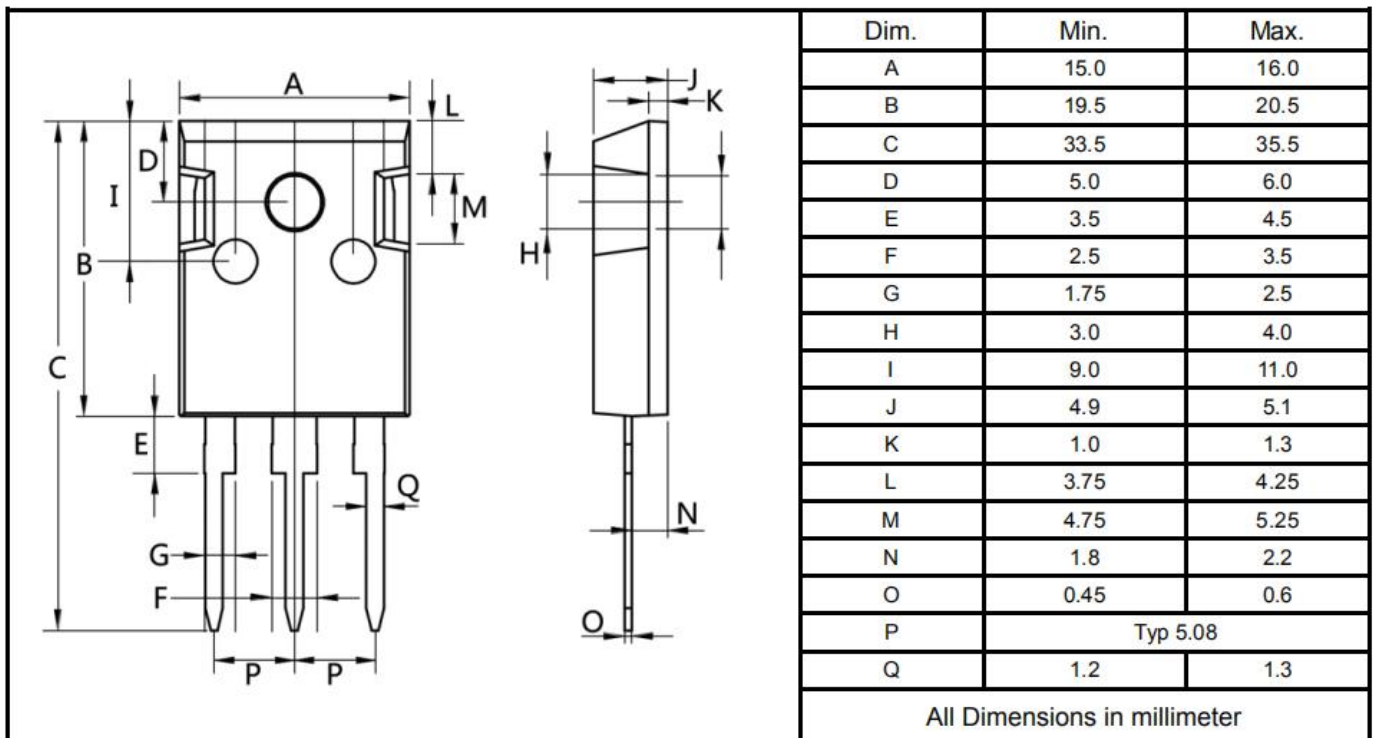

单击下面可查看定价，库存，交付和生命周期等信息

[>>YFW\(佑风微\)](#)