

## Surface Mount Schottky Barrier Rectifier

Reverse Voltage - 20 to 200 V

Forward Current – 3.0 A

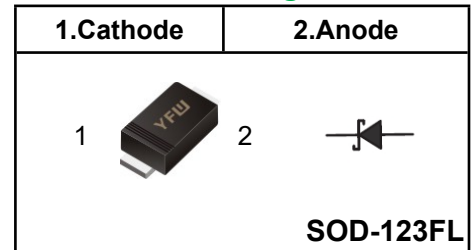
### FEATURES

- ◆Metal silicon junction, majority carrier conduction
- ◆For surface mounted applications
- ◆Low power loss, high efficiency
- ◆High forward surge current capability
- ◆For use in low voltage, high frequency inverters, free wheeling, and polarity protection applications
- ◆Lead free in comply with EU RoHS 2011/65/EU directives

### MECHANICAL DATA

- ◆Case: SOD-123FL
- ◆Terminals: Solderable per MIL-STD-750, Method 2026
- ◆Approx. Weight: 15mg / 0.00048oz

### Pinning



### Marking Code

DS32W	K32	S32
DS34W	K34	S34
DS36W	K36	S36
DS38W	K38	S38
DS310W	K310	S310
DS312W	K312	S312
DS315W	K315	S315
DS320W	K320	S320

#### Absolute Maximum Ratings and Electrical characteristics

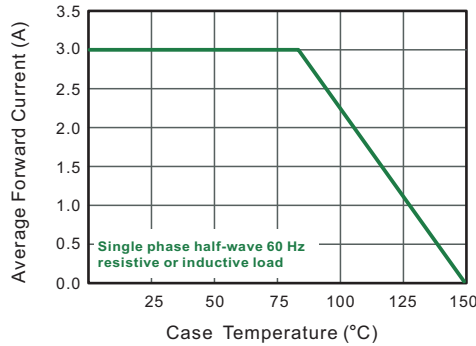
Ratings at 25 ° ambient temperature unless otherwise specified. Single phase, half wave, 60Hz resistive or inductive load, for capacitive load, derate by 20 %

Parameter	Symbols	DS32W	DS34W	DS36W	DS38W	DS310W	DS312W	DS315W	DS320W	Units
Maximum Repetitive Peak Reverse Voltage	$V_{RRM}$	20	40	60	80	100	120	150	200	V
Maximum RMS voltage	$V_{RMS}$	14	28	42	56	70	84	105	140	V
Maximum DC Blocking Voltage	$V_{DC}$	20	40	60	80	100	120	150	200	V
Maximum Average Forward Rectified Current	$I_{F(AV)}$	3.0								A
Peak Forward Surge Current, 8.3ms Single Half Sine-wave Superimposed On Rated Load (JEDEC method)	$I_{FSM}$	80				70				A
Maximum Instantaneous Forward Voltage at 3 A	$V_F$	0.55		0.70		0.85		0.90		V
Maximum Instantaneous Reverse Current at Rated DC Reverse Voltage <small><math>T_A = 25^{\circ}C</math> <math>T_A = 100^{\circ}C</math></small>	$I_R$	0.5 10		0.3 5						mA
Typical Junction Capacitance <sup>(1)</sup>	$C_j$	250			160					pF
Typical Thermal Resistance <sup>(2)</sup>	$R_{\theta JA}$	80								°C/W
Operating Junction Temperature Range	$T_j$	-55 ~ +150								°C
Storage Temperature Range	$T_{stg}$	-55 ~ +150								°C

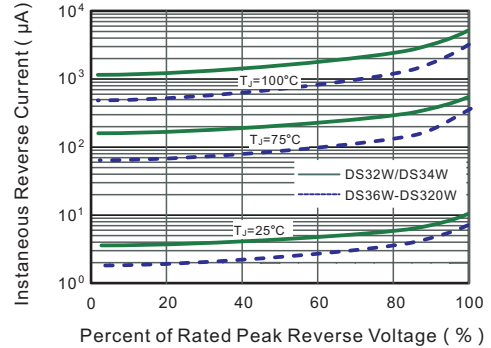
(1) Measured at 1 MHz and applied reverse voltage of 4 V D.C

(2) P.C.B. mounted with 2.0" X 2.0" (5 X 5 cm) copper pad areas.

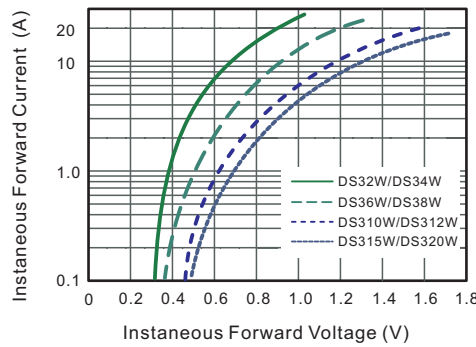
**Fig.1 Forward Current Derating Curve**



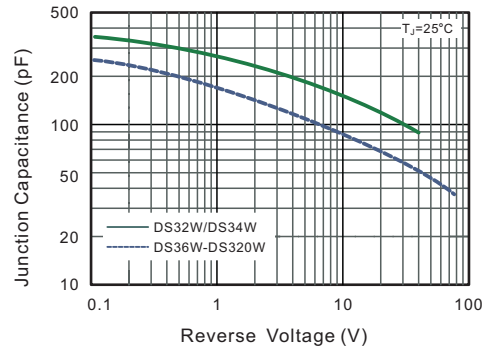
**Fig.2 Typical Reverse Characteristics**



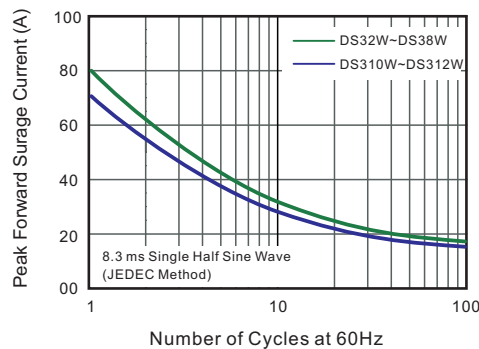
**Fig.3 Typical Forward Characteristic**



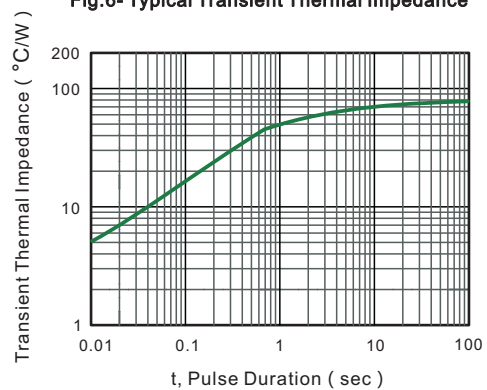
**Fig.4 Typical Junction Capacitance**



**Fig.5 Maximum Non-Repetitive Peak Forward Surge Current**

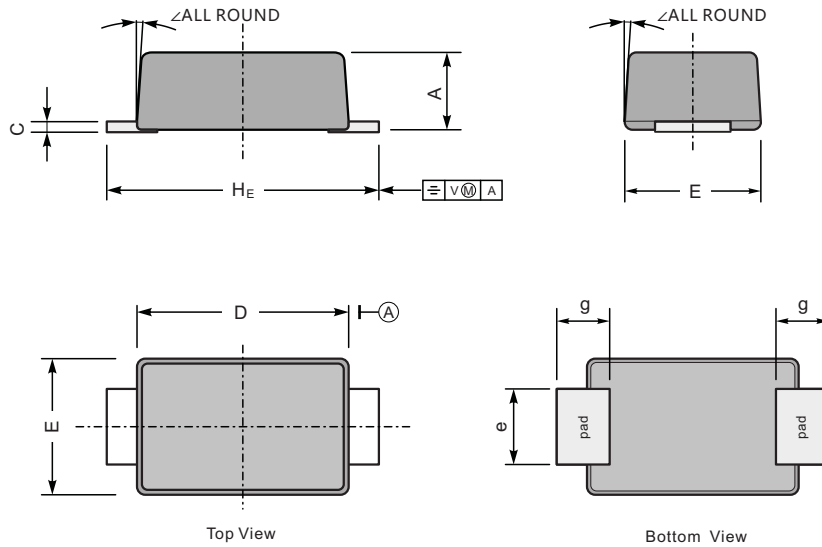


**Fig.6- Typical Transient Thermal Impedance**



**Package Outline SOD-123FL**

Plastic surface mounted package; 2 leads



UNIT		A	C	D	E	e	g	H <sub>E</sub>	$\angle$
mm	max	1.3	0.20	2.9	1.9	1.1	0.9	3.8	7°
	min	0.9	0.12	2.6	1.7	0.8	0.7	3.5	
mil	max	43	7.9	114	75	43	35	150	
	min	35	4.7	102	67	31	28	138	

**The recommended mounting pad size**



Unit:  $\frac{\text{mm}}{\text{mil}}$

**Summary of Packing Options**

Package	Packing Description	Packing Quantity	Industry Standard
SOD-123FL	Tape/Reel, 13" reel	10000	EIA-481-1
	Tape/Reel, 7" reel	3000	EIA-481-1

单击下面可查看定价，库存，交付和生命周期等信息

[>>YFW\(佑风微\)](#)