

## Surface Mount Superfast Recovery Rectifier

**Reverse Voltage - 50 to 600 V**

**Forward Current - 1 A**

### FEATURES

- ◆ Easy pick and place
- ◆ For surface mounted applications
- ◆ Low profile package
- ◆ Built-in strain relief
- ◆ Lead free in comply with EU RoHS 2011/65/EU directives

### MECHANICAL DATA

- ◆ Case: SOD-123FL
- ◆ Terminals: Solderable per MIL-STD-750, Method 2026
- ◆ Approx. Weight: 15mg / 0.00053oz

### Pinning

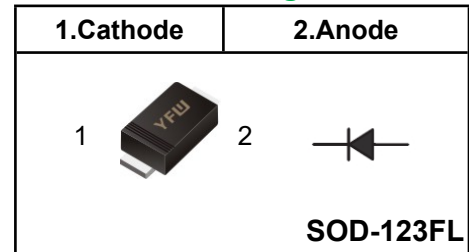

### Marking Code

<b>ES1AW</b>	<b>E1A</b>
<b>ES1BW</b>	<b>E1B</b>
<b>ES1DW</b>	<b>E1D</b>
<b>ES1GW</b>	<b>E1G</b>
<b>ES1JW</b>	<b>E1J</b>

### Absolute Maximum Ratings and characteristics

Ratings at 25 °C ambient temperature unless otherwise specified.

Single phase half-wave 60 Hz, resistive or inductive load, for capacitive load current derate by 20 %.

Parameter	Symbols	ES1AW	ES1BW	ES1DW	ES1GW	ES1JW	Units
Maximum Repetitive Peak Reverse Voltage	$V_{RRM}$	50	100	200	400	600	V
Maximum RMS voltage	$V_{RMS}$	35	70	140	280	420	V
Maximum DC Blocking Voltage	$V_{DC}$	50	100	200	400	600	V
Maximum Average Forward Rectified Current at $T_c = 125\text{ }^\circ\text{C}$	$I_{F(AV)}$	1					A
Peak Forward Surge Current 8.3 ms Single Half Sine Wave Superimposed on Rated Load	$I_{FSM}$	30					A
Maximum Instantaneous Forward Voltage at 1 A	$V_F$	0.95		1.25		1.65	V
Maximum DC Reverse Current $T_a = 25\text{ }^\circ\text{C}$ at Rated DC Blocking Voltage $T_a = 125\text{ }^\circ\text{C}$	$I_R$	5 100					$\mu\text{A}$
Typical Junction Capacitance at $V_R = 4\text{V}, f = 1\text{MHz}$	$C_j$	15					pF
Maximum Reverse Recovery Time <sup>(1)</sup>	$T_{rr}$	35					nS
Typical Thermal Resistance <sup>(2)</sup>	$R_{\theta JA}$	85					$^\circ\text{C/W}$
Operating and Storage Temperature Range	$T_j, T_{stg}$	-55 ~ +150					$^\circ\text{C}$

(1) Measured with  $I_F = 0.5\text{A}, I_R = 1\text{A}, I_n = 0.25\text{A}$

(2) P.C.B. mounted with 2.0" X 2.0" (5 X 5 cm) copper pad areas.

**Fig.1 Reverse Recovery Time Characteristic And Test Circuit Diagram**

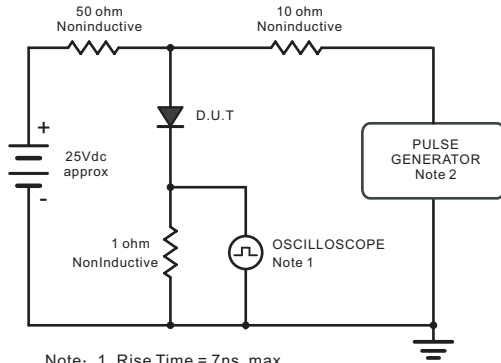

Note: 1. Rise Time = 7ns, max.  
Input Impedance = 1megohm, 22pF.  
2. Rise Time = 10ns, max.  
Source Impedance = 50 ohms.

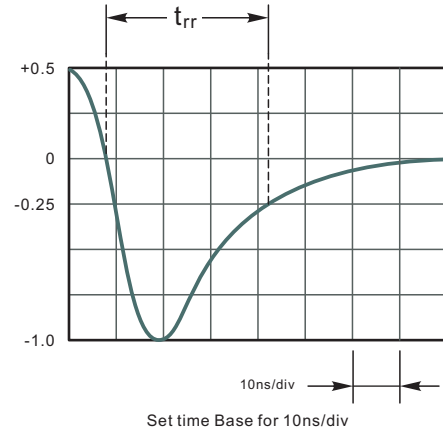

**Fig.2 Maximum Average Forward Current Rating**

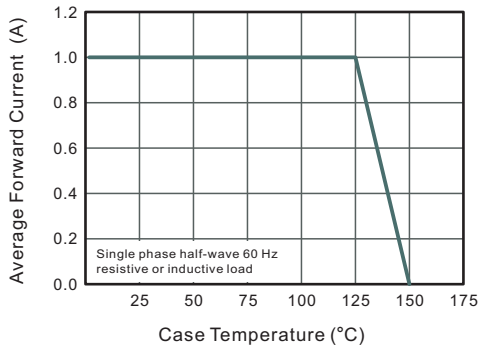

**Fig.3 Typical Reverse Characteristics**

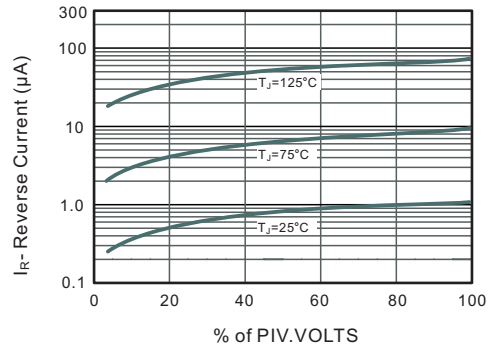

**Fig.4 Typical Forward Characteristics**

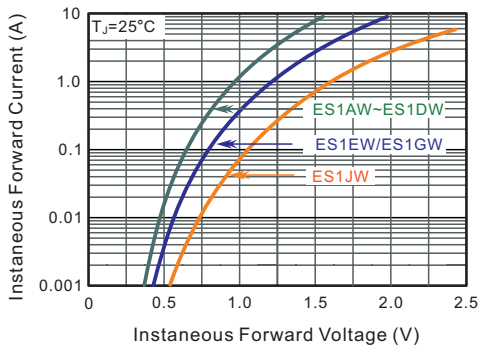

**Fig.5 Typical Junction Capacitance**

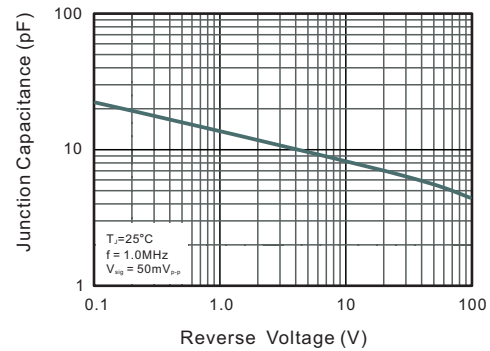

**Fig.6 Maximum Non-Repetitive Peak Forward Surge Current**

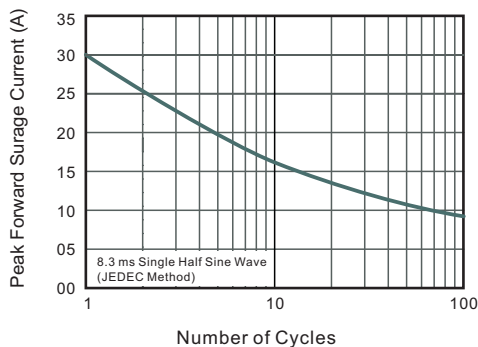

**Package Outline SOD-123FL**

Plastic surface mounted package; 2 leads



UNIT		A	C	D	E	e	g	H <sub>E</sub>	$\angle$
mm	max	1.3	0.20	2.9	1.9	1.1	0.9	3.8	7°
	min	0.9	0.12	2.6	1.7	0.8	0.7	3.5	
mil	max	43	7.9	114	75	43	35	150	
	min	35	4.7	102	67	31	28	138	

**The recommended mounting pad size**



Unit:  $\frac{\text{mm}}{\text{(mil)}}$

**Summary of Packing Options**

Package	Packing Description	Packing Quantity	Industry Standard
SOD-123FL	Tape/Reel, 13" reel	10000	EIA-481-1
	Tape/Reel, 7" reel	3000	EIA-481-1

单击下面可查看定价，库存，交付和生命周期等信息

[>>YFW\(佑风微\)](#)