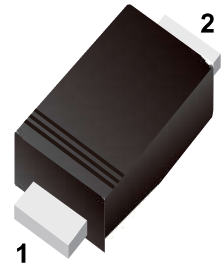

■ Ultrafast Efficient Rectifier
■ FEATURES

- Halogen-free type
- Compliance to RoHS product
- GPRC (Glass passivated rectifier chip) inside
- Lead less chip form, no lead damage
- Low power loss, High efficiency
- High current capability
- Plastic package has Underwriters Laboratory Flammability Classification 94V-0

■ Simplified outline(SOD-123FL)
■ APPLICATION

- High frequency rectification
- AC/DC Power Supply

■ MARKING

Marking	167
---------	-----

Absolute Maximum Ratings (Ta = 25 °C)

ITEM	Symbol	Conditions	BYD167	Unit
Repetitive peak reverse voltage	VRRM		600	V
Average forward current	IF(AV)	TL = 110 °C	1.0	A
Peak forward surge current	IFSM	8.3ms single half sine-wave	25	A
Reverse recovery time	Trr	IF = 0.5A, IR = 1.0A, Irr = 0.25A	35	nS
Operating storage temperature Range	Tj,TSTG		-65 to +175	°C

Electrical characteristics (Ta = 25 °C)

ITEM	Symbol	Conditions	Min.	Typ.	Max.	Unit
Forward voltage	VF	IF = 0.1A	-	0.85	-	V
		IF = 0.5A	-	1.15	-	
		IF = 1.0A	-	1.40	1.70	
Repetitive peak reverse current	IRRM	VR = Max. VRRM , Ta = 25 °C	-	0.20	5	uA
Junction capacitance	Cj	VR = 4V, f = 1.0 MHz	-	10	-	pF
Thermal resistance	Rth(JA)	Junction to ambient (NOTE 1)	-	80	-	°C/W
	Rth(JL)	Junction to lead (NOTE 1)	-	40	-	

NOTES : (1) Thermal resistance from junction to ambient and from junction to lead P.C.B. mounted on 0.2 x 0.2" (5.0 x 5.0mm) copper pad areas.
 (2) Preliminary draft.

FIG.1 - FORWARD CURRENT DERATING CURVE

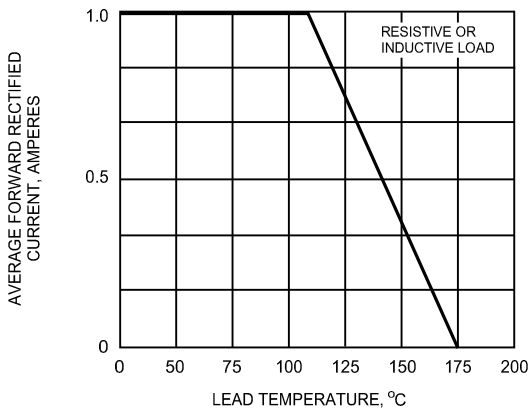

FIG.2 - MAXIMUM NON-REPETITIVE PEAK FORWARD SURGE CURRENT

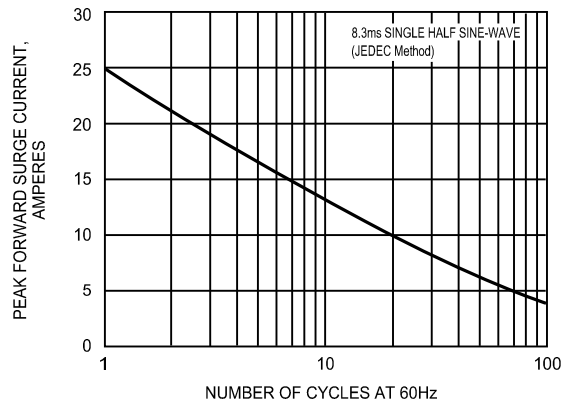

FIG.3 - TYPICAL INSTANTANEOUS FORWARD CHARACTERISTICS

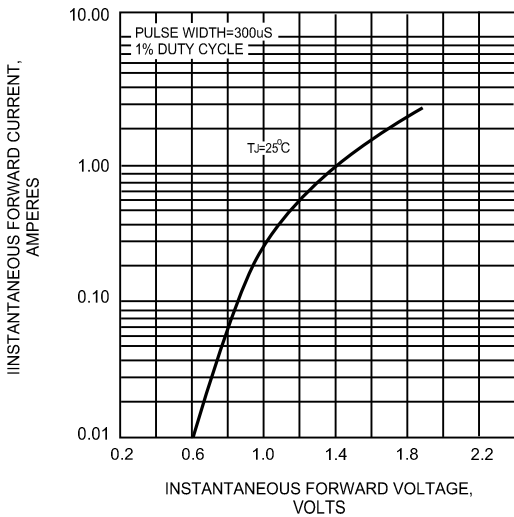

FIG.4 - TYPICAL REVERSE CHARACTERISTICS

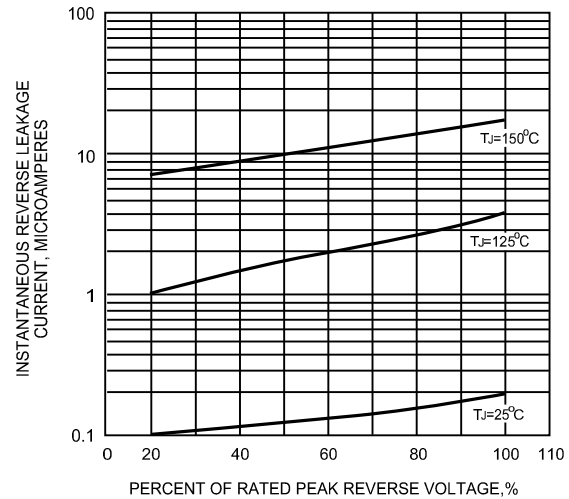
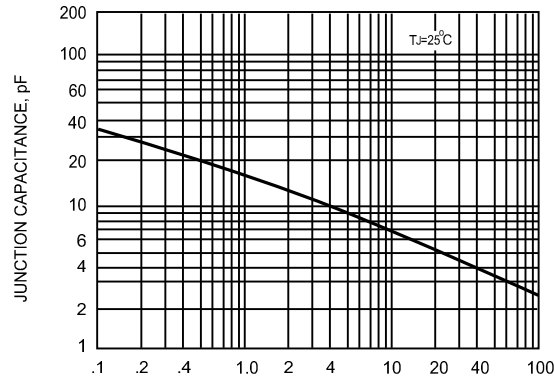
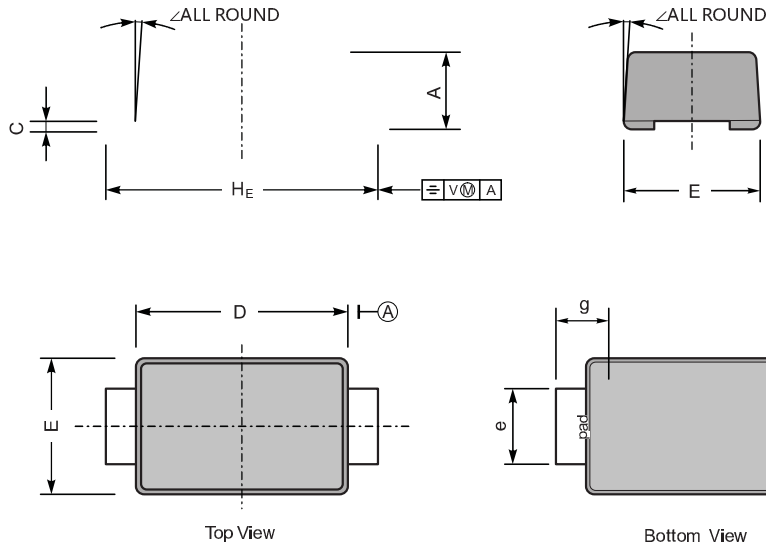

FIG.5 - TYPICAL JUNCTION CAPACITANCE



Package Outline SOD-123FL

Plastic surface mounted package; 2 leads



UNIT		A	C	D	E	e	g	H_E	\angle
mm	max	1.3	0.20	2.9	1.9	1.1	0.9	3.8	7°
	min	0.9	0.12	2.6	1.7	0.8	0.7	3.5	
mil	max	43	7.9	114	75	43	35	150	
	min	35	4.7	102	67	31	28	138	

The recommended mounting pad size

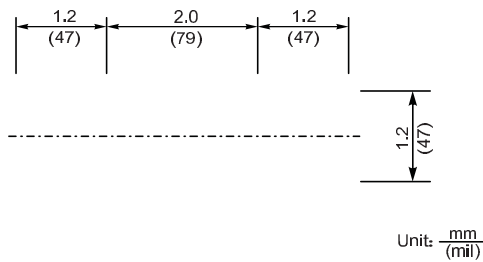

Summary of Packing Options

Package	Packing Description	Packing Quantity	Industry Standard
SOD-123FL	Tape/Reel, 13" reel	10000	EIA-481-1
	Tape/Reel, 7" reel	3000	EIA-481-1

单击下面可查看定价，库存，交付和生命周期等信息

[>>YFW\(佑风微\)](#)