

■ Zener Diodes

■ Features

- Planar die construction
- 200mW power dissipation on ceramic PBC
- General purpose, medium current
- Ideally suited for automated assembly processes
- Available in lead free version

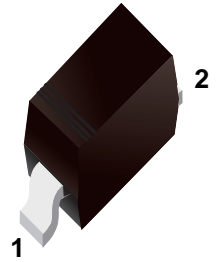

■ Simplified outline(SOD-323)

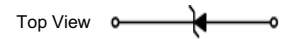

■ Absolute Maximum Ratings Ta = 25°C

Characteristic	Symbol	Value	Unit
Forward Voltage (Note 2) @ I _F = 10mA	V _F	0.9	V
Power Dissipation(Note 1)	P _D	200	mW
Thermal Resistance from Junction to Ambient	R _{θJA}	625	°C/W
Junction Temperature	T _j	150	°C
Storage Temperature Range	T _{stg}	-55~+150	°C

■ Electrical Characteristics Ta = 25°C

TYPE	Manking	Zener Voltage Range (Note 2)				Maximum Zener Impedance (Note 3)			Maximum Reverse Current (Note 2)		Typical Temperature Coefficient @ I _{ZTC} mV/°C		Test Current I _{ZTC}
		V _Z @I _{ZT}			I _{ZT}	ZZT@I _{ZT}	ZZK@I _{ZK}	I _{ZK}	I _R	V _R	Min	Max	mA
		Nom(V)	Min(V)	Max(V)	(mA)	Ω		(mA)	μA	V			
BZT52C2V4S	WX	2.4	2.20	2.60	5	100	600	1.0	50	1.0	-3.5	0	5
BZT52C2V7S	W1	2.7	2.5	2.9	5	100	600	1.0	20	1.0	-3.5	0	5
BZT52C3V0S	W2	3.0	2.8	3.2	5	95	600	1.0	10	1.0	-3.5	0	5
BZT52C3V3S	W3	3.3	3.1	3.5	5	95	600	1.0	5	1.0	-3.5	0	5
BZT52C3V6S	W4	3.6	3.4	3.8	5	90	600	1.0	5	1.0	-3.5	0	5
BZT52C3V9S	W5	3.9	3.7	4.1	5	90	600	1.0	3	1.0	-3.5	0	5
BZT52C4V3S	W6	4.3	4.0	4.6	5	90	600	1.0	3	1.0	-3.5	0	5
BZT52C4V7S	W7	4.7	4.4	5.0	5	80	500	1.0	3	2.0	-3.5	0.2	5
BZT52C5V1S	W8	5.1	4.8	5.4	5	60	480	1.0	2	2.0	-2.7	1.2	5
BZT52C5V6S	W9	5.6	5.2	6.0	5	40	400	1.0	1	2.0	-2	2.5	5
BZT52C6V2S	WA	6.2	5.8	6.6	5	10	150	1.0	3	4.0	0.4	3.7	5
BZT52C6V8S	WB	6.8	6.4	7.2	5	15	80	1.0	2	4.0	1.2	4.5	5
BZT52C7V5S	WC	7.5	7.0	7.9	5	15	80	1.0	1	5.0	2.5	5.3	5
BZT52C8V2S	WD	8.2	7.7	8.7	5	15	80	1.0	0.7	5.0	3.2	6.2	5
BZT52C9V1S	WE	9.1	8.5	9.6	5	15	100	1.0	0.5	6.0	3.8	7.0	5
BZT52C10S	WF	10	9.4	10.6	5	20	150	1.0	0.2	7.0	4.5	8.0	5
BZT52C11S	WG	11	10.4	11.6	5	20	150	1.0	0.1	8.0	5.4	9.0	5
BZT52C12S	WH	12	11.4	12.7	5	25	150	1.0	0.1	8.0	6.0	10.0	5
BZT52C13S	WI	13	12.4	14.1	5	30	170	1.0	0.1	8.0	7.0	11.0	5
BZT52C15S	WJ	15	13.8	15.6	5	30	200	1.0	0.1	10.5	9.2	13	5
BZT52C16S	WK	16	15.3	17.1	5	40	200	1.0	0.1	11.2	10.4	14	5
BZT52C18S	WL	18	16.8	19.1	5	45	225	1.0	0.1	12.6	12.4	16	5
BZT52C20S	WM	20	18.8	21.2	5	55	225	1.0	0.1	14.0	14.4	18.0	5
BZT52C22S	WN	22	20.8	23.3	5	55	250	1.0	0.1	15.4	16.4	20.0	5
BZT52C24S	WO	24	22.8	25.6	5	70	250	1.0	0.1	16.8	18.4	22.0	5
BZT52C27S	WP	27	25.1	28.9	2	80	300	0.5	0.1	18.9	21.4	25.3	2
BZT52C30S	WQ	30	28.0	32.0	2	80	300	0.5	0.1	21.0	24.4	29.4	2
BZT52C33S	WR	33	31.0	35.0	2	80	325	0.5	0.1	23.1	27.4	33.4	2
BZT52C36S	WS	36	34.0	38.0	2	90	350	0.5	0.1	25.2	30.4	37.4	2
BZT52C39S	WT	39	37.0	41.0	2	130	350	0.5	0.1	27.3	33.4	41.2	2
BZT52C43S	WU	43	40.0	46.0	2	100	700	1	0.1	32.0	10.0	12.0	5
BZT52C47S	WV	47	44.0	50.0	2	100	750	1.0	0.1	35.0	10.0	12.0	5
BZT52C51S	WW	51	48.0	54.0	2	100	750	1.0	0.1	38.0	10.0	12.0	5
BZT52C56S	XW	56	52.0	60.0	2	135	750	1.0	0.1	39.0	10.0	12.0	5
BZT52C62S	6E	62	58.0	66.0	2	200	1000	1.0	0.2	47.0	10.0	12.0	5
BZT52C68S	6F	68	64.0	72.0	2	250	1000	1.0	0.2	52.0	10.0	12.0	5
BZT52C75S	6H	75	70.0	79.0	2	250	1000	1.0	0.2	57.0	10.0	12.0	5

Notes: 1. Device mounted on ceramic PCB: 7.6mm x 9.4mm x 0.87mm with pad areas 25mm².
 2. Short duration test pulse used to minimize self-heating effect.
 3. f = 1kHz.

■ Typical Characteristics

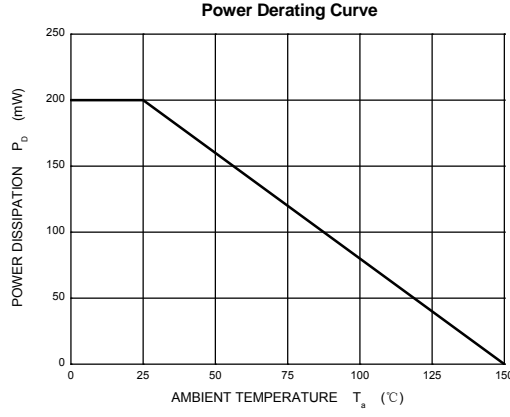
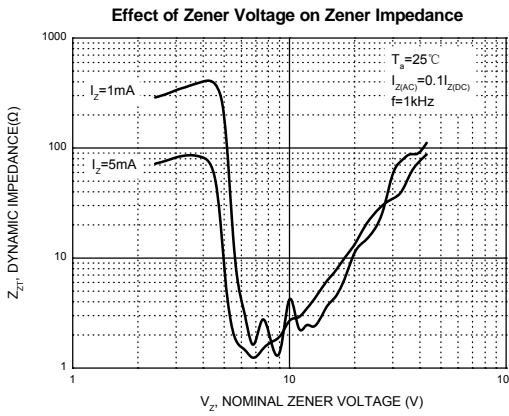
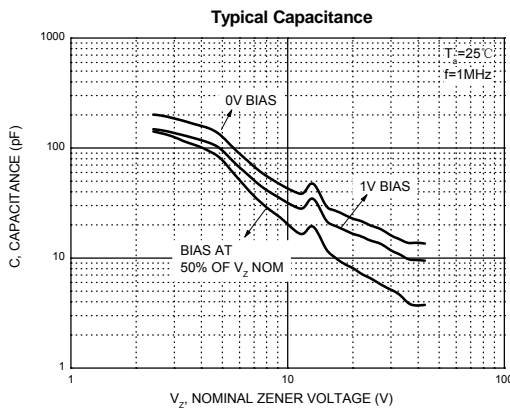
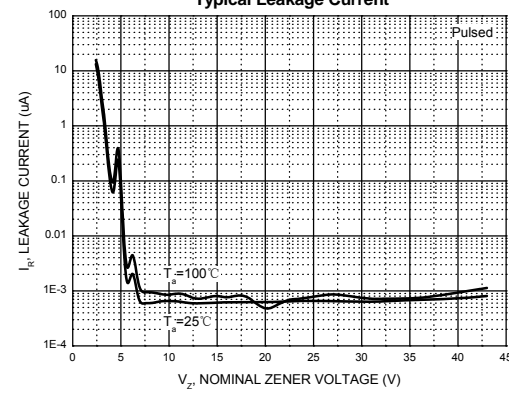
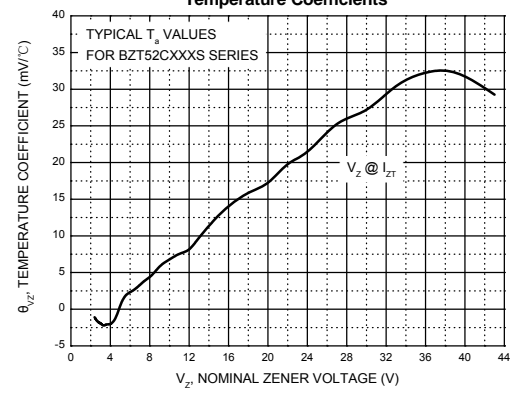
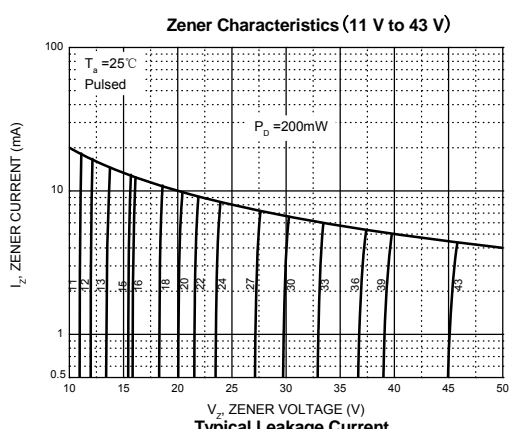
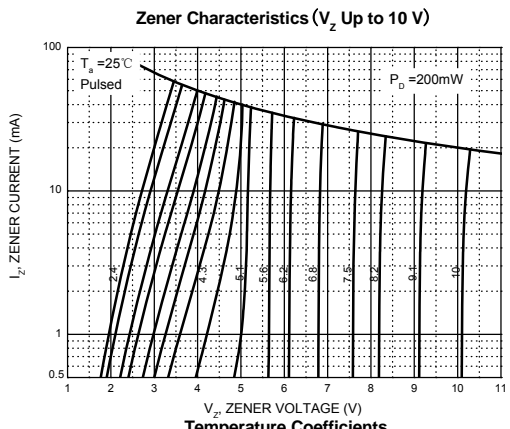

Package Outline

SOD-323

Plastic surface mounted package; 2 leads

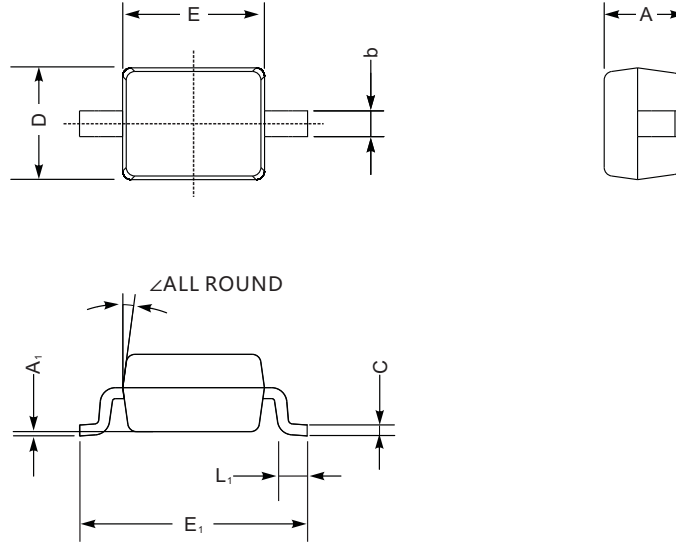

UNIT		A	C	D	E	E ₁	b	L ₁	A ₁	∠
mm	max	1.1	0.15	1.4	1.8	2.75	0.4	0.45	0.2	9°
	min	0.8	0.08	1.2	1.4	2.55	0.25	0.2	—	
mil	max	43	5.9	55	70	108	16	16	8	
	min	32	3.1	47	63	100	9.8	7.9	—	

The recommended mounting pad size

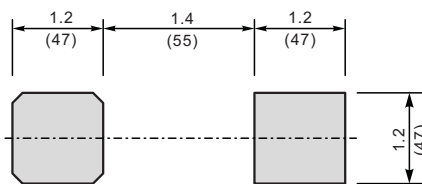

Unit: $\frac{\text{mm}}{\text{mil}}$

Summary of Packing Options

Package	Packing Description	Packing Quantity	Industry Standard
SOD-323	Tape/Reel, 7" reel	3000	EIA-481-1

单击下面可查看定价，库存，交付和生命周期等信息

[>>YFW\(佑风微\)](#)