

Surface Mount General Purpose Silicon Rectifiers

Reverse Voltage - 50 to 1000 V

Forward Current - 2 A

FEATURES

- ◆ For surface mounted applications
- ◆ Low profile package
- ◆ Glass Passivated Chip Junction
- ◆ Ideal for automated placement
- ◆ Lead free in comply with EU RoHS 2011/65/EU directives

MECHANICAL DATA

- ◆ Case: SMAF
- ◆ Terminals: Solderable per MIL-STD-750, Method 2026
- ◆ Approx. Weight: 27mg / 0.00095oz

Maximum Ratings and Electrical characteristics

Ratings at 25 °C ambient temperature unless otherwise specified.

Single phase half-wave 60 Hz, resistive or inductive load, for capacitive load current derate by 20 %.

Pinning

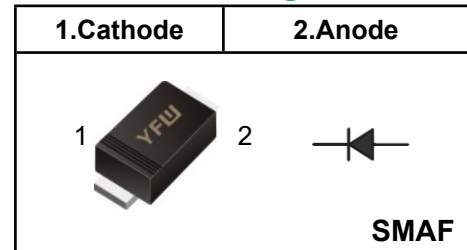

Marking Code

S2AF	S2A
S2BF	S2B
S2DF	S2D
S2GF	S2G
S2JF	S2J
S2KF	S2K
S2MF	S2M

Parameter	Symbols	S2AF	S2BF	S2DF	S2GF	S2JF	S2KF	S2MF	Units
Maximum Repetitive Peak Reverse Voltage	V_{RRM}	50	100	200	400	600	800	1000	V
Maximum RMS voltage	V_{RMS}	35	70	140	280	420	560	700	V
Maximum DC Blocking Voltage	V_{DC}	50	100	200	400	600	800	1000	V
Maximum Average Forward Rectified Current at $T_c = 125\text{ }^\circ\text{C}$	$I_{F(AV)}$	2							A
Peak Forward Surge Current 8.3 ms Single Half Sine Wave Superimposed on Rated Load	I_{FSM}	70							A
Maximum Instantaneous Forward Voltage at 2 A	V_F	1.1							V
Maximum DC Reverse Current $T_a = 25\text{ }^\circ\text{C}$ at Rated DC Blocking Voltage $T_a = 125\text{ }^\circ\text{C}$	I_R	5 100							μA
Typical Junction Capacitance ⁽¹⁾	C_j	22							pF
Typical Thermal Resistance ⁽²⁾	$R_{\theta JA} / R_{\theta JC}$	65/20							$^\circ\text{C/W}$
Operating and Storage Temperature Range	T_j, T_{stg}	-55 ~ +150							$^\circ\text{C}$

(1) Measured at 1 MHz and applied reverse voltage of 4 V D.C

(2) P.C.B. mounted with 2.0" X 2.0" (5 X 5 cm) copper pad areas.

Fig.1 Forward Current Derating Curve

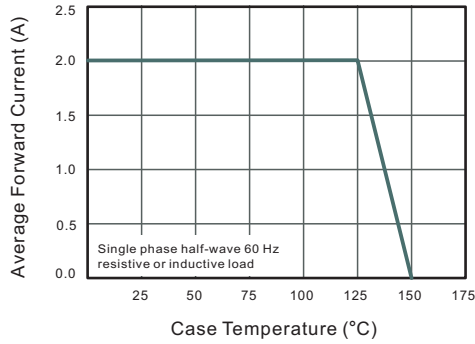

Fig.2 Typical Instaneous Reverse Characteristics

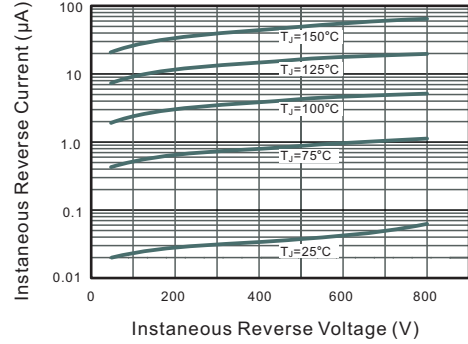

Fig.3 Typical Forward Characteristic

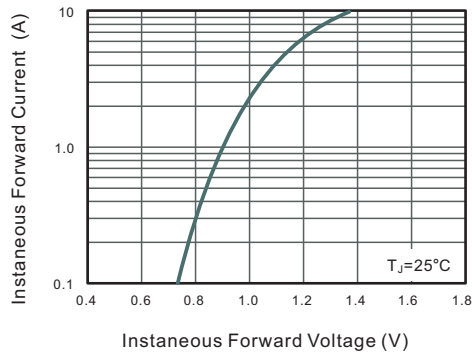

Fig.4 Typical Junction Capacitance

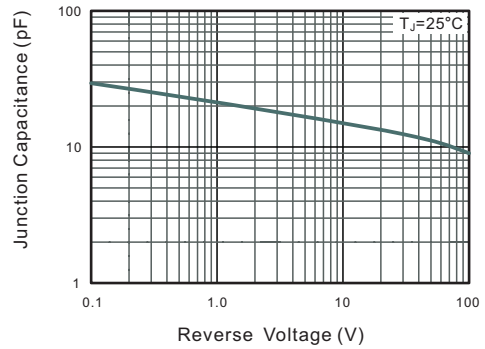
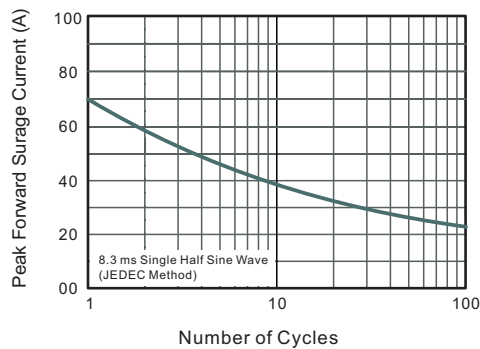

Fig.5 Maximum Non-Repetitive Peak Forward Surge Current



Package Outline

SMAF

Plastic surface mounted package; 2 leads

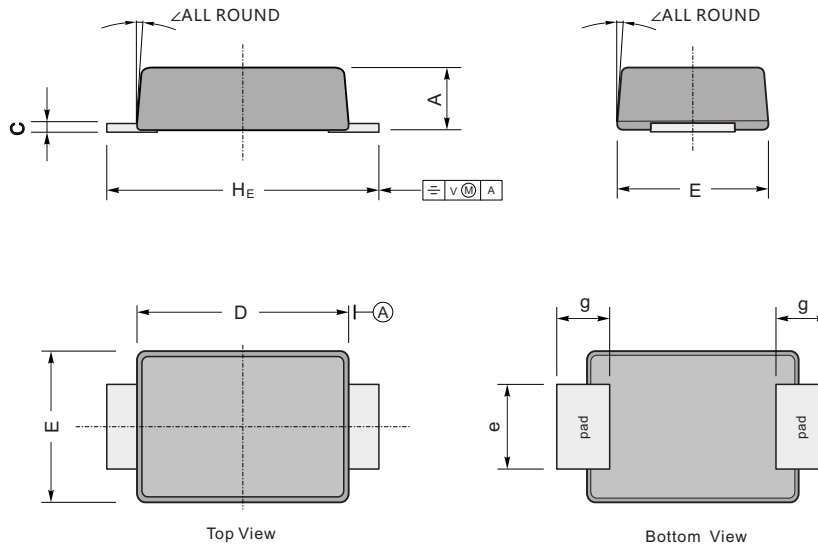

UNIT		A	C	D	E	e	g	H _E	∠
mm	max	1.1	0.20	3.7	2.7	1.6	1.2	4.9	7°
	min	0.9	0.12	3.3	2.4	1.3	0.8	4.4	
mil	max	43	7.9	146	106	63	47	193	
	min	35	4.7	130	94	51	31	173	

The recommended mounting pad size

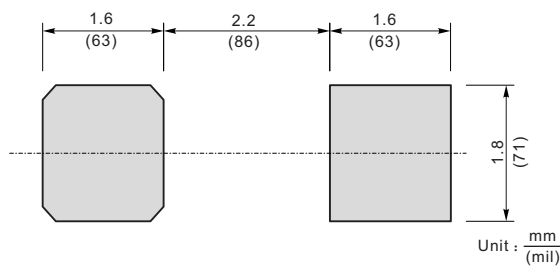

Summary of Packing Options

Package	Packing Description	Packing Quantity	Industry Standard
SMAF	Tape/Reel, 13" reel	10000	EIA-481-1
	Tape/Reel, 7" reel	3000	EIA-481-1

单击下面可查看定价，库存，交付和生命周期等信息

[>>YFW\(佑风微\)](#)