

Surface Mount Ultrafast Recovery Rectifier

Reverse Voltage - 50 to 1000 V

Forward Current - 5 A

FEATURES

- ◆ For surface mounted applications
- ◆ Low profile package
- ◆ Glass Passivated Chip Junction
- ◆ High efficiency
- ◆ Lead free in comply with EU RoHS 2011/65/EU directives

MECHANICAL DATA

- ◆ Case: DO-214AA/SMB
- ◆ Terminals: Solderable per MIL-STD-750, Method 2026
- ◆ Approx. Weight: 0.095g / 0.003oz

Maximum Ratings and characteristics

Ratings at 25 °C ambient temperature unless otherwise specified.

Single phase half-wave 60 Hz, resistive or inductive load, for capacitive load current derate by 20 %.

Pinning

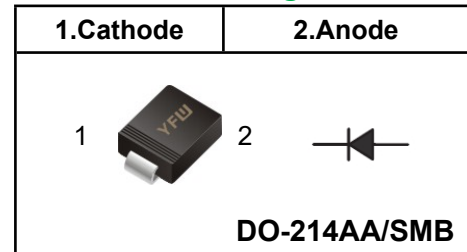

Marking Code

| | |
|--------------|-------------|
| US5AB | US5A |
| US5BB | US5B |
| US5DB | US5D |
| US5GB | US5G |
| US5JB | US5J |
| US5KB | US5K |
| US5MB | US5M |

| Parameter | Symbols | US5AB | US5BB | US5DB | US5GB | US5JB | US5KB | US5MB | Units | |
|---|---------------------------------|------------|-------|-------|-------|-------|-------|-------|--------------------|----|
| Maximum Repetitive Peak Reverse Voltage | V_{RRM} | 50 | 100 | 200 | 400 | 600 | 800 | 1000 | V | |
| Maximum RMS voltage | V_{RMS} | 35 | 70 | 140 | 280 | 420 | 560 | 700 | V | |
| Maximum DC Blocking Voltage | V_{DC} | 50 | 100 | 200 | 400 | 600 | 800 | 1000 | V | |
| Maximum Average Forward Rectified Current at $T_c = 125\text{ }^\circ\text{C}$ | $I_{F(AV)}$ | 5 | | | | | | | A | |
| Peak Forward Surge Current 8.3 ms Single Half Sine Wave Superimposed on Rated Load | I_{FSM} | 100 | | | | | | | A | |
| Maximum Instantaneous Forward Voltage at 5 A | V_F | 0.95 | | 1.25 | | 1.65 | | | V | |
| Maximum DC Reverse Current $T_a = 25\text{ }^\circ\text{C}$ at Rated DC Blocking Voltage $T_a = 125\text{ }^\circ\text{C}$ | I_R | 5 100 | | | | | | | μA | |
| Maximum Reverse Recovery Time ⁽¹⁾ | T_{rr} | 50 | | | | 75 | | | | nS |
| Typical Thermal Resistance ⁽²⁾ | $R_{\theta JA} / R_{\theta JC}$ | 45/15 | | | | | | | $^\circ\text{C/W}$ | |
| Operating and Storage Temperature Range | T_j, T_{stg} | -55 ~ +150 | | | | | | | $^\circ\text{C}$ | |

(1) Measured with $I_F=0.5\text{A}, I_R=1\text{A}, I_n=0.25\text{A}$

(2) P.C.B. mounted with 2.0" X 2.0" (5 X 5 cm) copper pad areas.

Fig.1 Maximum Average Forward Current Rating

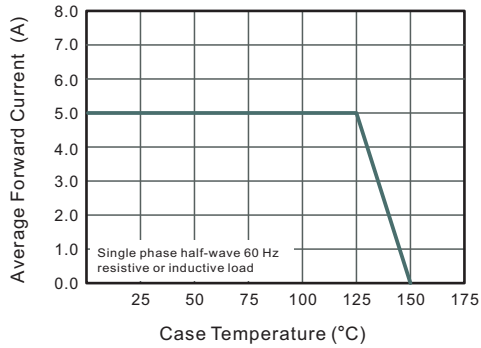

Fig.2 Typical Reverse Characteristics

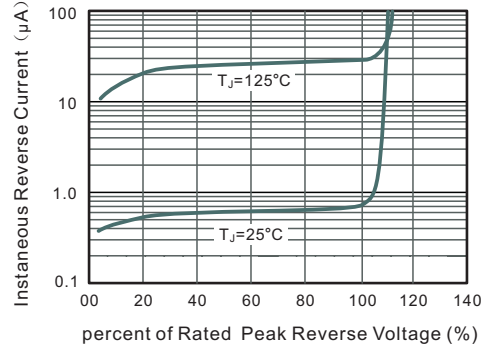

Fig.3 Typical Forward Characteristics

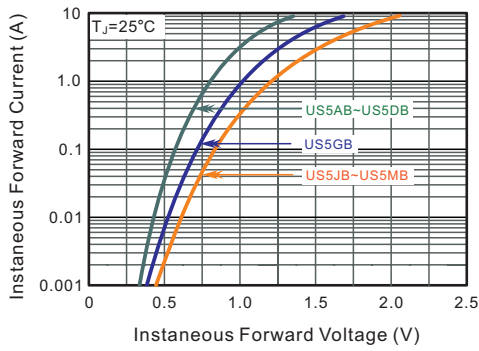
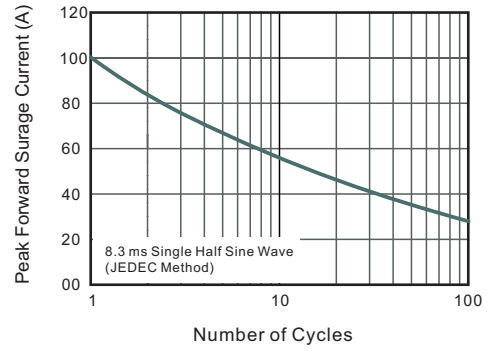
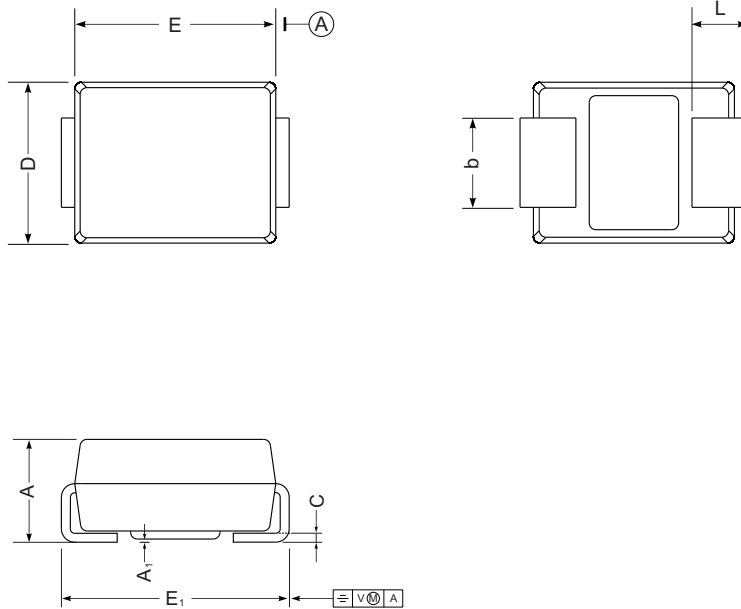

Fig.4 Maximum Non-Repetitive Peak Forward Surge Current



Package Outline DO-214AA SMB

Plastic surface mounted package; 2 leads



| UNIT | | A | E | D | E ₁ | A ₁ | L | C | b |
|------|-----|------|------|------|----------------|----------------|-----|-------|-----|
| mm | max | 2.44 | 4.70 | 3.94 | 5.59 | 0.20 | 1.5 | 0.305 | 2.2 |
| | min | 2.13 | 4.06 | 3.3 | 5.08 | 0.05 | 0.8 | 0.152 | 1.9 |
| mil | max | 96 | 185 | 155 | 220 | 7.9 | 59 | 12 | 87 |
| | min | 84 | 160 | 130 | 200 | 2.0 | 32 | 6 | 75 |

The recommended mounting pad size

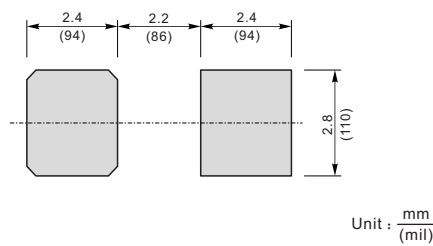

Summary of Packing Options

| Package | Packing Description | Packing Quantity | Industry Standard |
|--------------|---------------------|------------------|-------------------|
| DO-214AA SMB | Tape/Reel, 13" reel | 3000 | EIA-481-1 |

单击下面可查看定价，库存，交付和生命周期等信息

[>>YFW\(佑风微\)](#)