

Surface mount transient voltage suppressor power 200 watts

**Reverse Voltage -5.0V to 440 V**

**Forward Current - 20 A**

## FEATURES

- ◆ For surface mounted applications in order to optimize board space.
- ◆ Low profile package
- ◆ Glass passivated junction
- ◆ Low inductance
- ◆ Plastic package has Underwriters Laboratory Flammability

## MECHANICAL DATA

- ◆ Case: SOD-123FL
- ◆ Terminals: Solderable per MIL-STD-750, Method 2026
- ◆ Approx. Weight: 15mg/0.00048oz

## Maximum Ratings and Electrical characteristics

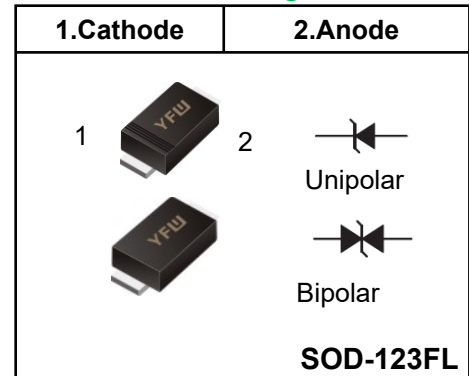
Ratings at 25 °C ambient temperature unless otherwise specified.

| Parameter  | Symbol             | Value       | Unit |
|--|--------------------|-------------|------|
| Peak Pulse Power Dissipation on TA=25°C (Note 1,2,5, Fig1) | $P_{PPM}$          | 200         | W    |
| Peak Forward Surge Current (Note 3)                        | $I_{FSM}$<br>(UNI) | 20          | A    |
| Peak Pulse Current on 10/1000 us waveform (Note 1 Fig)2    | $I_{PPM}$          | see Table 1 | A    |
| Steady State Power Dissipation (Note 4)                    | $P_{M(AV)}$        | 1           | W    |
| Operating Junction and Storage Range                       | $T_J, T_{STG}$     | -55 to +150 | °C   |
| Typical Thermal Resistance                                 | $R_{\theta JA}$    | 180         | °C/W |

### NOTES

1. Non-repetitive current pulse per Fig 3 and derated above  $T_A=25^\circ\text{C}$  per Fig 2
2. Mounted on 5mm<sup>2</sup> copper pads to each terminal
3. 8.3ms single half sinewave, or equivalent square wave duty cycle=4 pulses per minutes maximum
4. lead temperature at  $T_L=75^\circ\text{C}$
5. Peak pulse powe. waveform is  $t_p=10/1000\text{us}$
6. A transient suppressor is selected according to the working peak reverse voltage( $V_{RWM}$ ), Which Should be equal to or greater than the DC or continuous peak operating voltage level

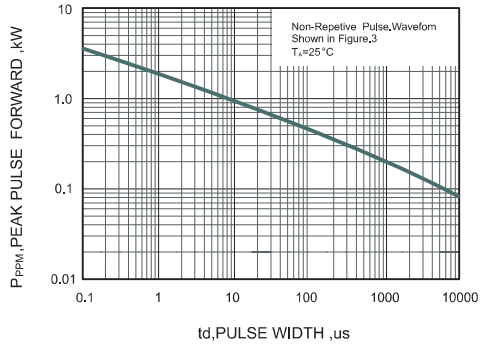
## Pinning



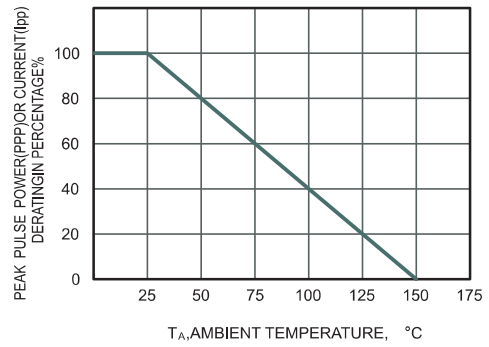
Characteristics at Ta = 25°C

| Type    |          | Marking |      | VRMW | Breakdown Voltage                |      | Test           | Reverse   | Max.     | Peak Pulse |
|---------|----------|---------|------|------|----------------------------------|------|----------------|-----------|----------|------------|
|         |          |         |      |      | V <sub>BR</sub> @ I <sub>T</sub> |      | I <sub>T</sub> | IR @ VRWM | VC @ IPP | IPP        |
|         |          |         |      |      | Min                              | Max  |                |           |          |            |
| Uni     | Bi       | Uni     | Bi   | V    | V                                | V    | mA             | μA        | V        | A          |
| SMF5.0A | SMF5.0CA | AE      | CAE  | 5    | 6.4                              | 7    | 10             | 400       | 9.2      | 21.7       |
| SMF6.0A | SMF6.0CA | AG      | CAG  | 6    | 6.67                             | 7.37 | 10             | 400       | 10.3     | 19.4       |
| SMF6.5A | SMF6.5CA | AK      | CAK  | 6.5  | 7.22                             | 7.98 | 10             | 250       | 11.2     | 17.9       |
| SMF7.0A | SMF7.0CA | AM      | CAM  | 7    | 7.78                             | 8.6  | 10             | 100       | 12       | 16.7       |
| SMF7.5A | SMF7.5CA | AP      | CAP  | 7.5  | 8.33                             | 9.21 | 1              | 50        | 12.9     | 15.5       |
| SMF8.0A | SMF8.0CA | AR      | CAR  | 8    | 8.89                             | 9.83 | 1              | 25        | 13.6     | 14.7       |
| SMF8.5A | SMF8.5CA | AT      | CAT  | 8.5  | 9.44                             | 10.4 | 1              | 10        | 14.4     | 13.9       |
| SMF9.0A | SMF9.0CA | AV      | CAV  | 9    | 10                               | 11.1 | 1              | 5         | 15.4     | 13         |
| SMF10A  | SMF10CA  | AX      | CAX  | 10   | 11.1                             | 12.3 | 1              | 2.5       | 17       | 11.8       |
| SMF11A  | SMF11CA  | AZ      | CAZ  | 11   | 12.2                             | 13.5 | 1              | 2.5       | 18.2     | 11         |
| SMF12A  | SMF12CA  | BE      | CBE  | 12   | 13.3                             | 14.7 | 1              | 2.5       | 19.9     | 10.1       |
| SMF13A  | SMF13CA  | BG      | CBG  | 13   | 14.4                             | 15.9 | 1              | 1         | 21.5     | 9.3        |
| SMF14A  | SMF14CA  | BK      | CBK  | 14   | 15.6                             | 17.2 | 1              | 1         | 23.2     | 8.6        |
| SMF15A  | SMF15CA  | BM      | CBM  | 15   | 16.7                             | 18.5 | 1              | 1         | 24.4     | 8.2        |
| SMF16A  | SMF16CA  | BP      | CBP  | 16   | 17.8                             | 19.7 | 1              | 1         | 26       | 7.7        |
| SMF17A  | SMF17CA  | BR      | CBR  | 17   | 18.9                             | 20.9 | 1              | 1         | 27.6     | 7.2        |
| SMF18A  | SMF18CA  | BT      | CBT  | 18   | 20                               | 22.1 | 1              | 1         | 29.2     | 6.8        |
| SMF20A  | SMF20CA  | BV      | CBV  | 20   | 22.2                             | 24.5 | 1              | 1         | 32.4     | 6.2        |
| SMF22A  | SMF22CA  | BX      | CBX  | 22   | 24.4                             | 26.9 | 1              | 1         | 35.5     | 5.6        |
| SMF24A  | SMF24CA  | BZ      | CBZ  | 24   | 26.7                             | 29.5 | 1              | 1         | 38.9     | 5.1        |
| SMF26A  | SMF26CA  | CE      | CCE  | 26   | 28.9                             | 31.9 | 1              | 1         | 42.1     | 4.8        |
| SMF28A  | SMF28CA  | CG      | CCG  | 28   | 31.1                             | 34.4 | 1              | 1         | 45.4     | 4.4        |
| SMF30A  | SMF30CA  | CK      | CCK  | 30   | 33.3                             | 36.8 | 1              | 1         | 48.4     | 4.1        |
| SMF33A  | SMF33CA  | CM      | CCM  | 33   | 36.7                             | 40.6 | 1              | 1         | 53.3     | 3.8        |
| SMF36A  | SMF36CA  | CP      | CCP  | 36   | 40                               | 44.2 | 1              | 1         | 58.1     | 3.4        |
| SMF40A  | SMF40CA  | CR      | CCR  | 40   | 44.4                             | 49.1 | 1              | 1         | 64.5     | 3.1        |
| SMF43A  | SMF43CA  | CT      | CCT  | 43   | 47.8                             | 52.8 | 1              | 1         | 69.4     | 2.9        |
| SMF45A  | SMF45CA  | CV      | CCV  | 45   | 50                               | 55.3 | 1              | 1         | 72.7     | 2.8        |
| SMF48A  | SMF48CA  | CX      | CCX  | 48   | 53.3                             | 58.9 | 1              | 1         | 77.4     | 2.6        |
| SMF51A  | SMF51CA  | CZ      | CCZ  | 51   | 56.7                             | 62.7 | 1              | 1         | 82.4     | 2.4        |
| SMF54A  | SMF54CA  | DE      | CDE  | 54   | 60                               | 66.3 | 1              | 1         | 87.1     | 2.3        |
| SMF58A  | SMF58CA  | DG      | CDG  | 58   | 64.4                             | 71.2 | 1              | 1         | 93.6     | 2.1        |
| SMF60A  | SMF60CA  | DK      | CDK  | 60   | 66.7                             | 73.7 | 1              | 1         | 96.8     | 1.8        |
| SMF64A  | SMF64CA  | DM      | CDM  | 64   | 71.1                             | 78.6 | 1              | 1         | 103      | 1.7        |
| SMF70A  | SMF70CA  | DP      | CDP  | 70   | 77.8                             | 86   | 1              | 1         | 113      | 1.5        |
| SMF75A  | SMF75CA  | DR      | CDR  | 75   | 83.3                             | 92.1 | 1              | 1         | 121      | 1.4        |
| SMF78A  | SMF78CA  | DT      | CDT  | 78   | 86.7                             | 95.8 | 1              | 1         | 126      |            |
| SMF85A  | SMF85CA  | DV      | CDV  | 85   | 94.4                             | 104  | 1              | 1         | 137      | 1.3        |
| SMF90A  | SMF90CA  | DX      | CDX  | 90   | 100                              | 111  | 1              | 1         | 146      | 1.2        |
| SMF100A | SMF100CA | DZ      | CDZ  | 100  | 111                              | 123  | 1              | 1         | 162      | 1.1        |
| SMF110A | SMF110CA | EE      | CEE  | 110  | 122                              | 135  | 1              | 1         | 177      | 1          |
| SMF120A | SMF120CA | EG      | CEG  | 120  | 133                              | 147  | 1              | 1         | 193      | 0.9        |
| SMF130A | SMF130CA | EK      | CEK  | 130  | 144                              | 159  | 1              | 1         | 209      | 0.8        |
| SMF150A | SMF150CA | EM      | CEM  | 150  | 167                              | 185  | 1              | 1         | 243      | 0.7        |
| SMF160A | SMF160CA | EP      | CEP  | 160  | 178                              | 197  | 1              | 1         | 259      |            |
| SMF170A | SMF170CA | ER      | CER  | 170  | 189                              | 209  | 1              | 1         | 275      | 0.6        |
| SMF180A | SMF180CA | ET      | CET  | 180  | 201                              | 222  | 1              | 1         | 292      | 0.5        |
| SMF190A | SMF190CA | EV      | CEV  | 190  | 211                              | 232  | 1              | 1         | 308      |            |
| SMF200A | SMF200CA | EX      | CEX  | 200  | 224                              | 247  | 1              | 1         | 324      |            |
| SMF220A | SMF220CA | E22     | CE22 | 220  | 246                              | 272  | 1              | 1         | 356      |            |
| SMF250A | SMF250CA | E25     | CE25 | 250  | 279                              | 309  | 1              | 1         | 405      |            |
| SMF300A | SMF300CA | E30     | CE30 | 300  | 335                              | 371  | 1              | 1         | 486      | 0.45       |
| SMF350A | SMF350CA | E35     | CE35 | 350  | 391                              | 432  | 1              | 1         | 567      | 0.4        |
| SMF400A | SMF400CA | E40     | CE40 | 400  | 447                              | 494  | 1              | 1         | 648      | 0.35       |
| SMF440A | SMF440CA | E44     | CE44 | 440  | 492                              | 543  | 1              | 1         | 713      | 0.3        |

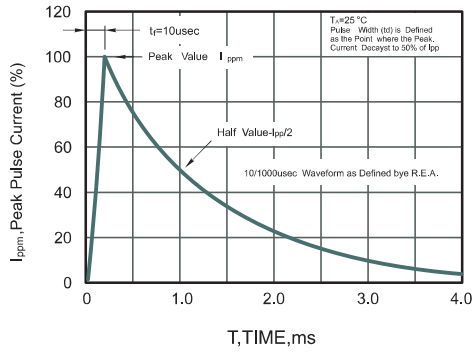
**Fig.1 Peak Pulse Power Rating Curve**



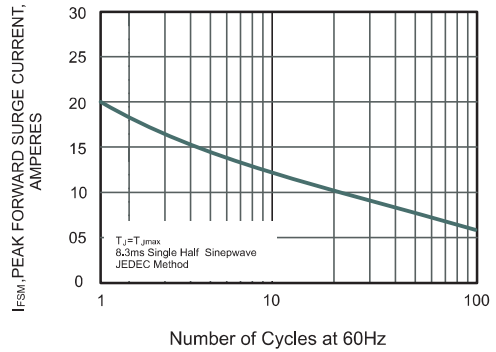
**Fig.2 Forward Current Derating Curve**



**Fig.3 Pulse Waveform**

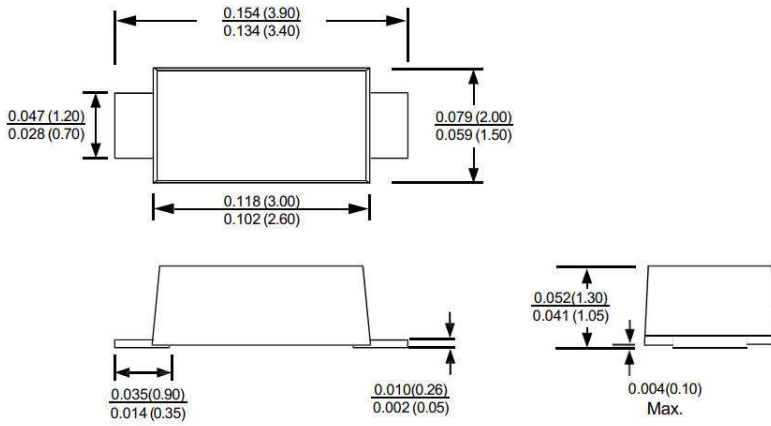


**Fig.4 Maximum Non-Repetitive Peak Forward Surge Current**

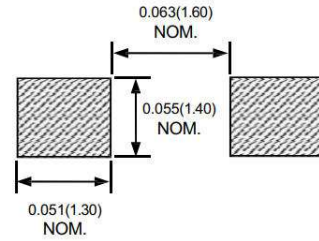


**Package Outline**

**SOD-123FL**



**Mounting Pad Layout**



**Summary of Packing Options**

| Package   | Packing Description | Packing Quantity | Industry Standard |
|-----------|---------------------|------------------|-------------------|
| SOD-123FL | Tape/Reel,13"reel   | 10000            | EIA-481-1         |
|           | Tape/Reel,7"reel    | 3000             | EIA-481-1         |

单击下面可查看定价，库存，交付和生命周期等信息

[>>YFW\(佑风微\)](#)