

Surface Mount Schottky Barrier Rectifier

Reverse Voltage - 20 to 200 V

Forward Current - 2 A

FEATURES

- ◆Metal silicon junction, majority carrier conduction
- ◆For surface mounted applications
- ◆Low power loss, high efficiency
- ◆High forward surge current capability
- ◆For use in low voltage, high frequency inverters, free wheeling, and polarity protection applications
- ◆Lead free in comply with EU RoHS 2011/65/EU directives

MECHANICAL DATA

- ◆Case: SMAF
- ◆Terminals: Solderable per MIL-STD-750, Method 2026
- ◆Approx. Weight: 27mg / 0.00095oz

Pinning

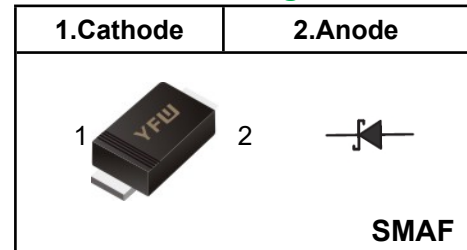

Marking Code

| | |
|---------------|--------------|
| SS22F | SS22 |
| SS24F | SS24 |
| SS26F | SS26 |
| SS28F | SS28 |
| SS210F | SS210 |
| SS212F | SS212 |
| SS215F | SS215 |
| SS220F | SS220 |

Absolute Maximum Ratings and Electrical characteristics

Ratings at 25 ° ambient temperature unless otherwise specified. Single phase, half wave, 60Hz resistive or inductive load, for capacitive load, derate by 20 %

| Parameter | Symbols | SS22F | SS24F | SS26F | SS28F | SS210F | SS212F | SS215F | SS220F | Units |
|--|-----------------|------------|-------|-------|----------|--------|--------|--------|--------|-------|
| Maximum Repetitive Peak Reverse Voltage | V_{RRM} | 20 | 40 | 60 | 80 | 100 | 120 | 150 | 200 | V |
| Maximum RMS voltage | V_{RMS} | 14 | 28 | 42 | 56 | 70 | 84 | 105 | 140 | V |
| Maximum DC Blocking Voltage | V_{DC} | 20 | 40 | 60 | 80 | 100 | 120 | 150 | 200 | V |
| Maximum Average Forward Rectified Current | $I_{F(AV)}$ | 2.0 | | | | | | | | A |
| Peak Forward Surge Current, 8.3ms Single Half Sine-wave Superimposed On Rated Load (JEDEC method) | I_{FSM} | 50 | | | | 40 | | | | A |
| Maximum Instantaneous Forward Voltage at 2 A | V_F | 0.55 | | 0.70 | | 0.85 | | 0.95 | | V |
| Maximum Instantaneous Reverse Current at Rated DC Reverse Voltage <small>$T_A = 25^\circ C$ $T_A = 100^\circ C$</small> | I_R | 0.5 5 | | | 0.3 3 | | | | mA | |
| Typical Junction Capacitance ⁽¹⁾ | C_j | 160 | | | 80 | | | | pF | |
| Typical Thermal Resistance ⁽²⁾ | $R_{\theta JA}$ | 80 | | | | | | | | °C/W |
| Operating Junction Temperature Range | T_j | -55 ~ +150 | | | | | | | | °C |
| Storage Temperature Range | T_{stg} | -55 ~ +150 | | | | | | | | °C |

(1) Measured at 1 MHz and applied reverse voltage of 4 V D.C

(2) P.C.B. mounted with 2.0" X 2.0" (5 X 5 cm) copper pad areas.

Fig.1 Forward Current Derating Curve

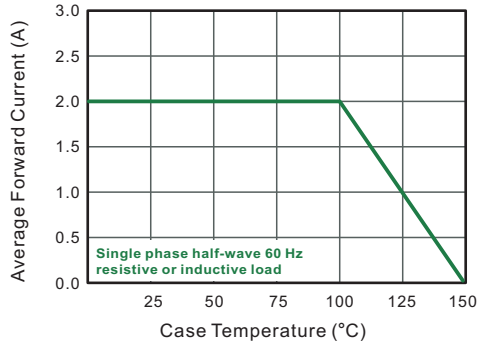

Fig.2 Typical Reverse Characteristics

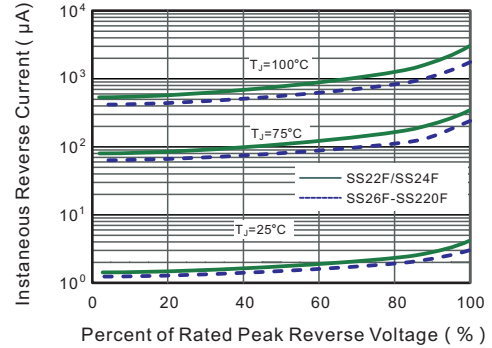

Fig.3 Typical Forward Characteristic

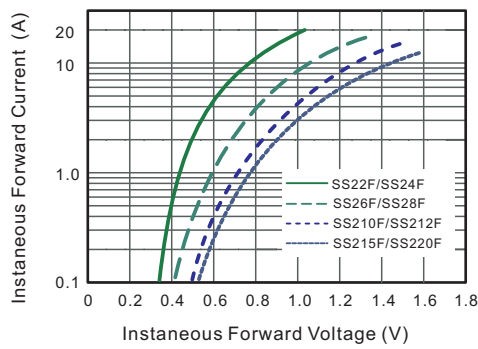

Fig.4 Typical Junction Capacitance

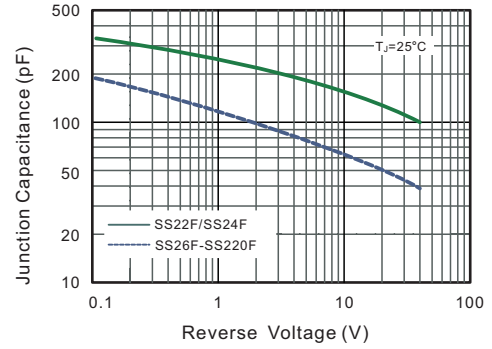

Fig.5 Maximum Non-Repetitive Forward Surge Current

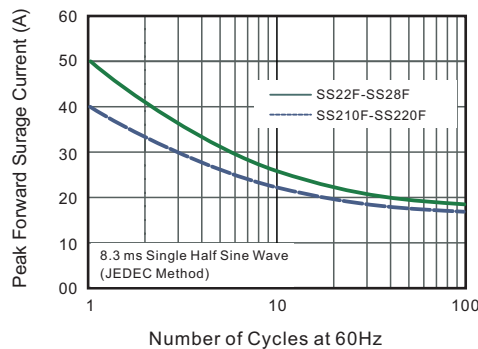
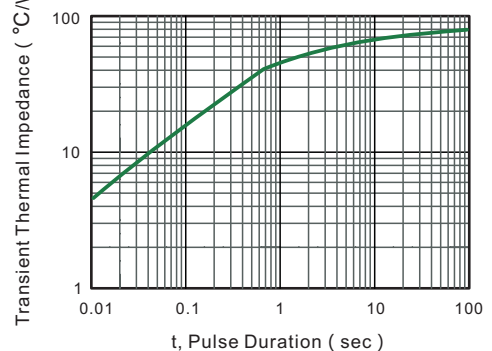

Fig.6- Typical Transient Thermal Impedance



Package Outline

SMAF

Plastic surface mounted package; 2 leads

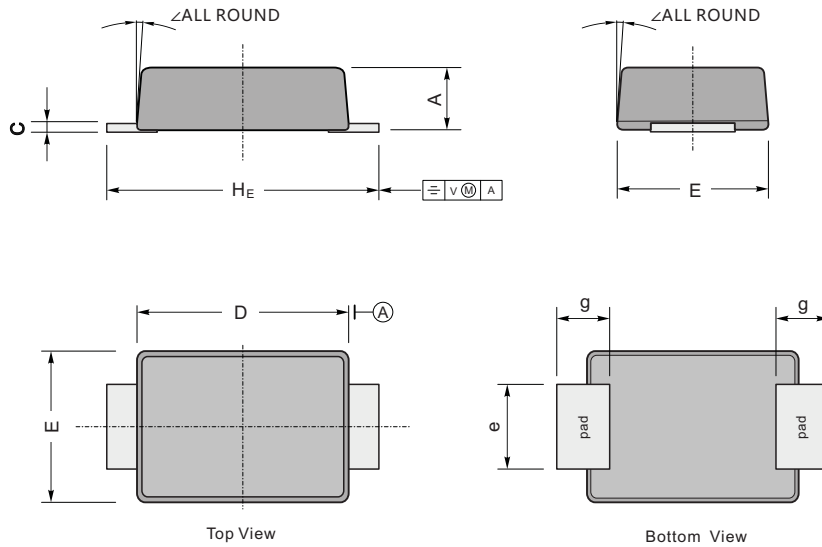

| UNIT | | A | C | D | E | e | g | H _E | \angle |
|------|-----|-----|------|-----|-----|-----|-----|----------------|----------|
| mm | max | 1.1 | 0.20 | 3.7 | 2.7 | 1.6 | 1.2 | 4.9 | 7° |
| | min | 0.9 | 0.12 | 3.3 | 2.4 | 1.3 | 0.8 | 4.4 | |
| mil | max | 43 | 7.9 | 146 | 106 | 63 | 47 | 193 | |
| | min | 35 | 4.7 | 130 | 94 | 51 | 31 | 173 | |

The recommended mounting pad size

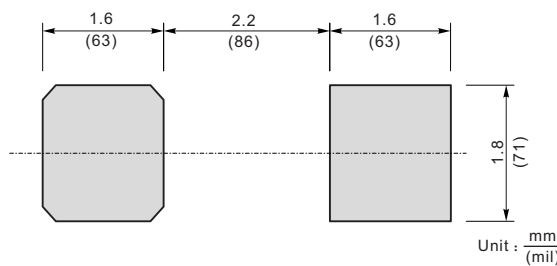

Summary of Packing Options

| Package | Packing Description | Packing Quantity | Industry Standard |
|---------|---------------------|------------------|-------------------|
| SMAF | Tape/Reel, 13" reel | 10000 | EIA-481-1 |
| | Tape/Reel, 7" reel | 3000 | EIA-481-1 |

单击下面可查看定价，库存，交付和生命周期等信息

[>>YFW\(佑风微\)](#)