

40A 3Quadrants TRIACs

Product Summary

Symbol	Value	Unit
$I_{T(RMS)}$	40	A
$V_{DRM} V_{RRM}$	800/1200/1600	V
V_{TM}	1.55	V

Features

With high ability to withstand the shock loading of large current, With high commutation performances, 3 quadrants products especially recommended for use on inductive load

Application

Washing machine, vacuums, massager, solid state relay, AC Motor speed regulation and so on.

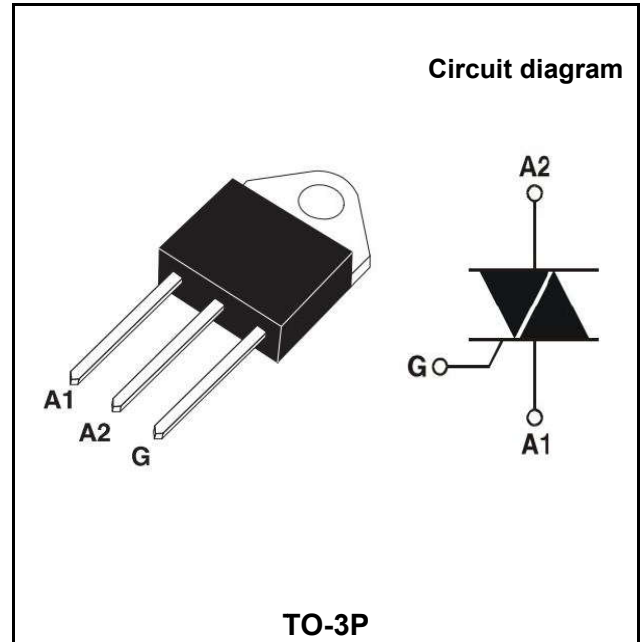

Order Information

Part Number	Package	Marking	Packing	Packing Quantity
BTA41-800BW	TO-3P	BTA41-800BW XXXX	box	600PCS/box
BTA41-1200BW	TO-3P	BTA41-1200BW XXXX	box	600PCS/box
BTA41-1600BW	TO-3P	BTA41-1600BW XXXX	box	600PCS/box

Absolute maximum ratings (Ta=25°C unless otherwise noted)

Parameter	Symbol	Value	Unit
Repetitive peak off-state voltage	V_{DRM}	800/1200/1600	V
Repetitive peak reverse voltage	V_{RRM}	800/1200/1600	V
RMS on-state current	$I_{T(RMS)}$	40	A
Non repetitive surge peak on-state current (full cycle, F=50Hz)	I_{TSM}	400	A
I^2t value for fusing (tp=10ms)	I^2t	880	A ² S
Critical rate of rise of on-state current ($I_G = 2 \times I_{GT}$)	di/dt	50	A/ μ s
Peak gate current	I_{GM}	4	A
Average gate power dissipation	$P_G (AV)$	1	W
Junction Temperature	T_J	-40-+125	°C
Storage Temperature	T_{STG}	-40 ~+150	°C

Electrical characteristics (TA=25°C, unless otherwise noted)

Parameter	Symbol	Test Condition		Value		Unit
Gate trigger current	I_{GT}	$V_D=12V R=33\Omega$	I - II - III	MAX.	50	mA
Gate trigger voltage	V_{GT}			MAX.	1.3	V
Gate non-trigger voltage	V_{GD}	$V_D=V_{DRM} T_j=125^\circ C$	I - II - III	MIN.	0.2	V
latching current	I_L	$I_G=1.2I_{GT}$	I - III	MAX.	80	mA
Holding current	I_H	$I_T=100mA$	II	MAX.	100	mA
Critical-rate of rise of commutation voltage	dV_D/dt	$V_D=2/3V_{DRM}$ Gate Open $T_j=125^\circ C$		MIN.	1000	V/μs

STATIC CHARACTERISTICS

Forward "on" voltage	V_{TM}	$I_{TM}=60A t_p=380\mu s$		MAX.	1.55	V
Repetitive Peak Off-State Current	I_{DRM}	$V_D=V_{DRM} V_R=V_{RRM}$	$T_j=25^\circ C$	MAX.	10	μA
Repetitive Peak Reverse Current	I_{RRM}		$T_j=125^\circ C$	MAX.	5	mA

THERMAL RESISTANCES

Thermal resistance	$R_{th(j-c)}$	Junction to case	TYP.	0.9	$^\circ C/W$
	$R_{th(j-a)}$	Junction to ambient	TYP.	50	$^\circ C/W$

Ordering Information

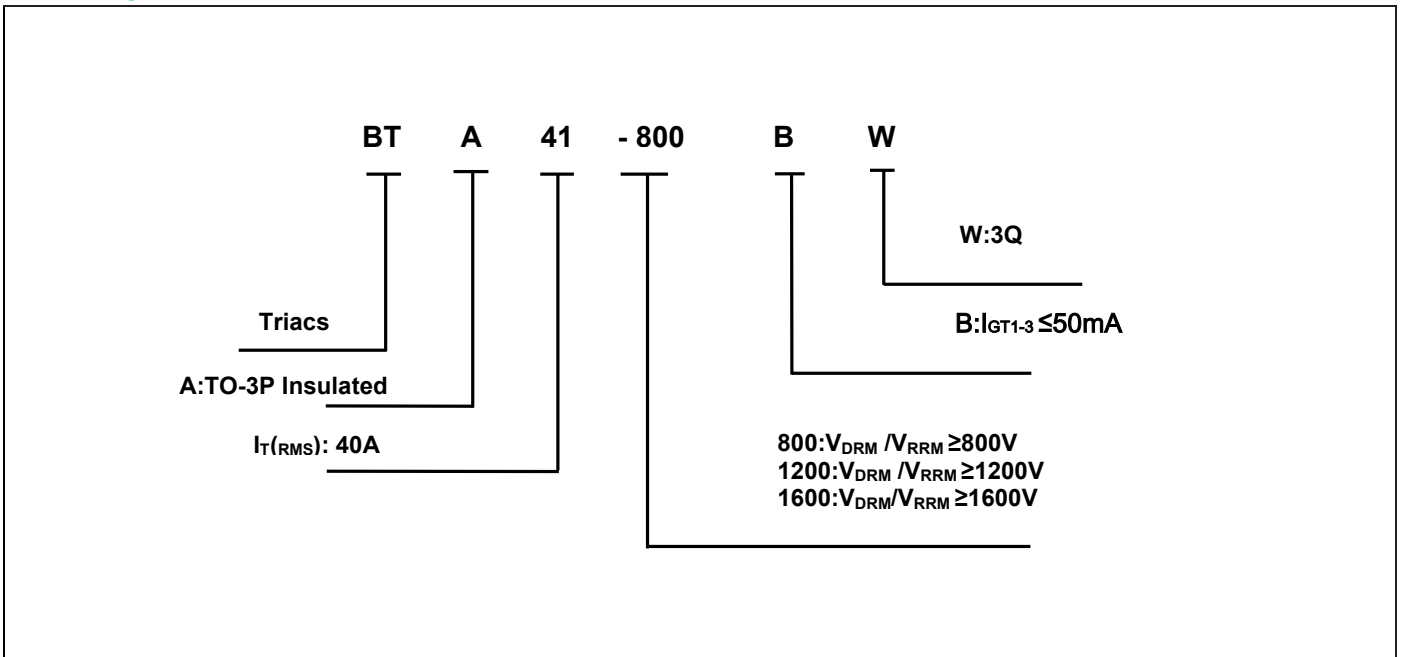

Typical Characteristics

FIG.1: Maximum power dissipation versus RMS on-state current (full cycle)

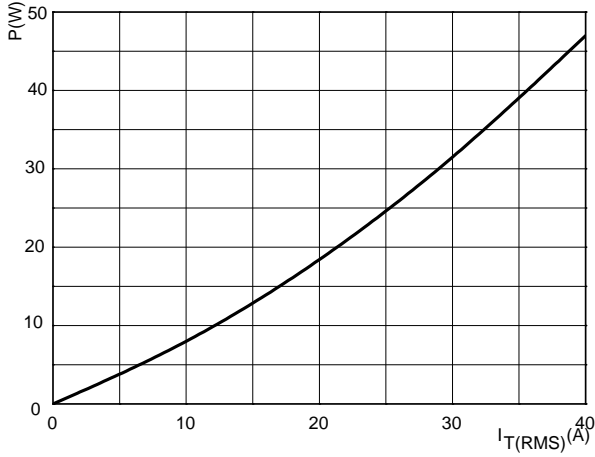

FIG.2: RMS on-state current versus case temperature (full cycle)

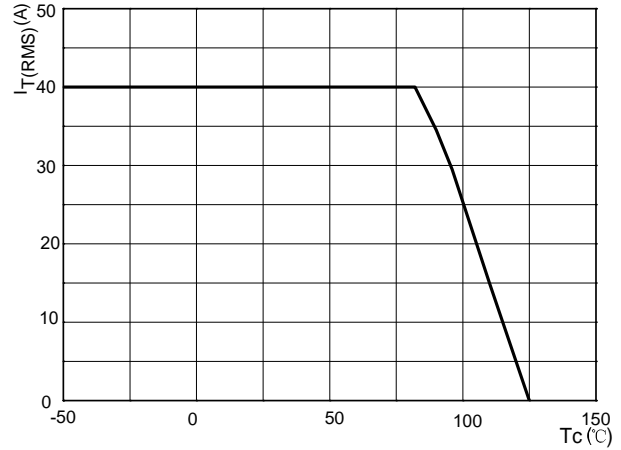

FIG.3: Surge peak on-state current versus number of cycles

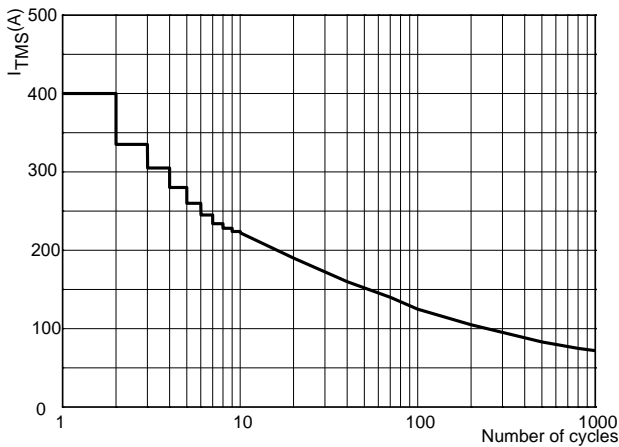

FIG.4: On-state characteristics (maximum values)

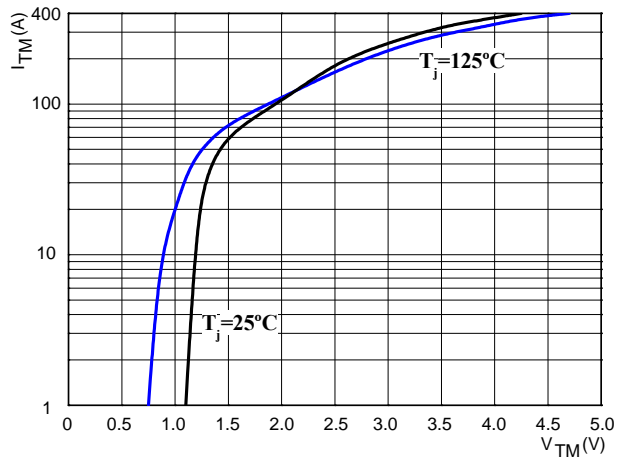

FIG.5: Non-repetitive surge peak on-state current for a sinusoidal pulse with width $t_p < 10\text{ms}$

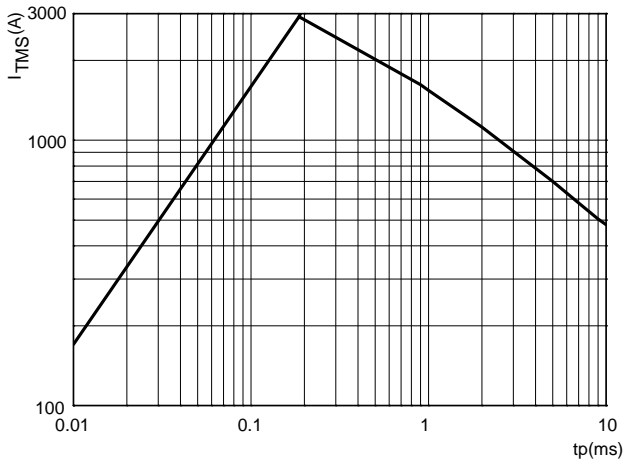
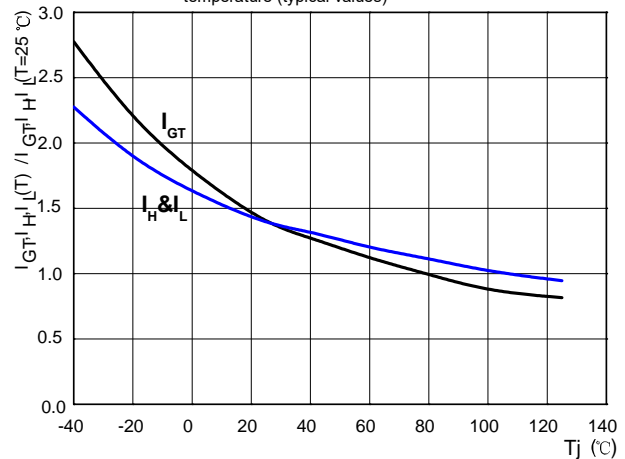
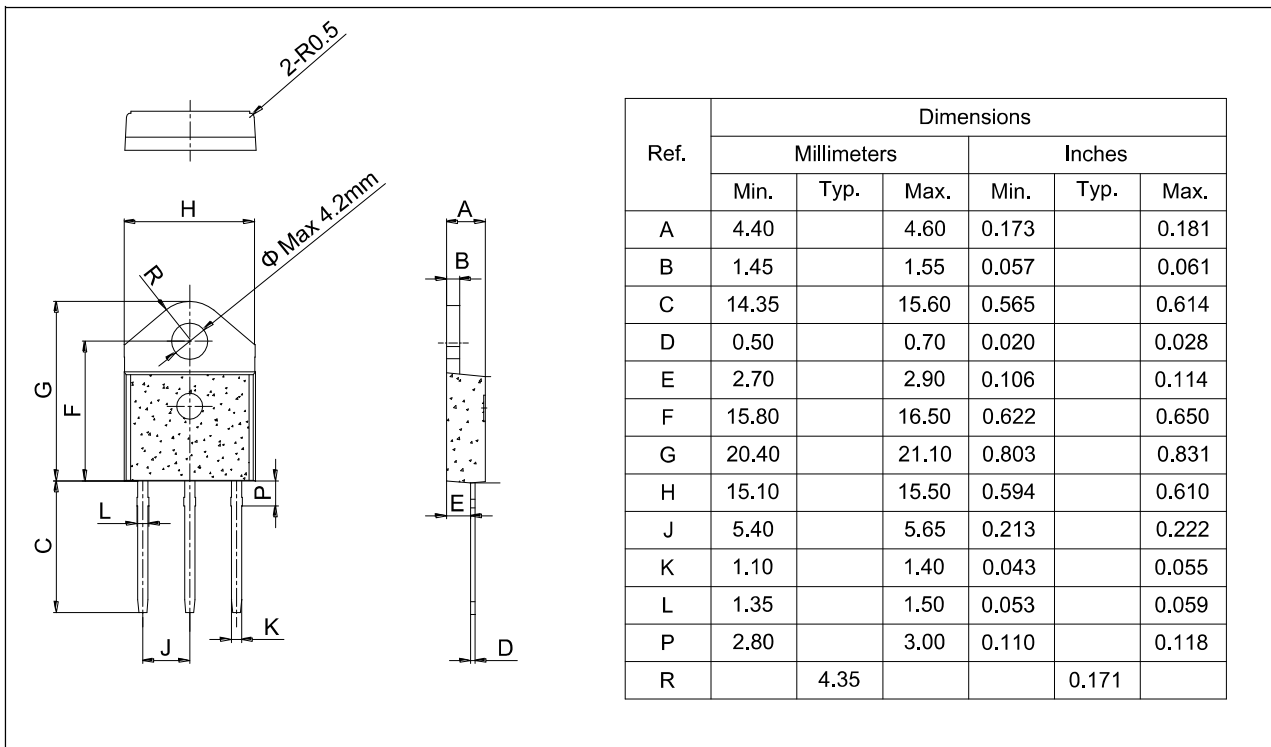

FIG.6: Relative variations of gate trigger current, holding current and latching current versus junction temperature (typical values)



Package Information

TO-3P



单击下面可查看定价，库存，交付和生命周期等信息

[>>YFW\(佑风微\)](#)